

# GENERAL CATALOGUE

TECH PORCELAIN

**lAnd**  
PORCELANICO

GENERAL CATALOGUE 2017

# INDEX

## INDICE . ÍNDICE

Pag	COLLECTIONS COLLEZIONI. COLECCIONES
126	AUSTRAL
110	AZULCASCAIS
118	CELTIC
60	CIVIC
202	DAGON
164	GALLERY + SLIM
188	GALLERY WALL
198	ISMO
204	JAMTLAND
203	JERUSALEM
68	KANKARE <sup>new</sup>
134	LEGNO + SLIM
80	MATTER + SLIM
158	MENSA
28	MIDLAND <sup>new</sup>
16	NOUVEAU
200	ORIGIN
96	PIETRA SERENA
40	PORTLAND + SLIM
4	RAMBLA <sup>new</sup>
148	ROOTS
205	COMPLEMENTS

Pag	CONTENTS CONTENUTI. CONTENIDOS
218	CERTIFICATES CERTIFICAZIONI.CERTIFICADOS
219	ENVIRONMENTAL INFORMATION BILANCIO ECOLOGICO.EQUILIBRIO ECOLÓGICO
220	GUIDELINES: INSTALLATION AND MAINTENANCE CONSIGLI PER LA POSA E PULIZIA.CONSEJOS DE COLOCACIÓN Y LIMPIEZA.
223	PACKING LIST IMBALLAGIO.LISTA DE EMBALAJE
217	SLIP RESISTANCE PROPRIETÀ ANTISCIVOLO.PROPIEDADES ANTIDESLIZAMIENTO
206	SPECIAL PIECES PEZZI SPECIALI.PIEZAS ESPECIALES
212	TECHNICAL SOLUTIONS. SOLUZIONI TECNICHE. SOLUCIONES TÉCNICAS
212	FAÇADES.FACCIATE.FACHADAS
214	RAISED FLOORS.PAVIMENTI SOPRAELEVATI.PAVIMENTO SOBREELEVADO
222	DIGITAL PRINTING.STAMPA DIGITALE.IMPRESIÓN DIGITAL
222	WATER JET CUTTING.TAGLIO A GETTO D'AQUA.CORTE DE AGUA
208	3D CONCEPT PEZZI TRIDIMENSIONALE. PIEZAS TRIDIMENSIONALES

# PRODUCT INDEX

## INDICE DEI PRODOTTI. ÍNDICE DE PRODUCTO

CONCEPTS  
CONCEPTOS

PAGE  
PAGINA

COLLECTIONS  
COLLEZIONI. COLECCIONES

COLOURS  
COLORI. COLORES

FINISHES  
FINITURE. ACABADOS

CONCEPTS	PAGE	COLLECTIONS	COLOURS	FINISHES
CONCEPTOS	PAGINA	COLLEZIONI. COLECCIONES	COLORI. COLORES	FINITURE. ACABADOS
ENCAUSTIC tech	04	RAMBLA <sup>new</sup>	ivory abyss alchemy clip random	natural
	16	NOUVEAU	ivory light dark random inox	natural lappato
CONCRETE tech	28	MIDLAND <sup>new</sup>	ivory vison grey	natural corrugato
	40	PORTLAND + SLIM	ivory vison grey	natural lappato slim natural hexagon
	60	CIVIC	ivory grey antracita	natural
	200	ORIGIN	marfil crema gris savanna antracita	natural lappato
STONE tech	68	KANKARE <sup>new</sup>	ivory vison grey	natural
	80	MATTER + SLIM	ivory grey	natural slim natural square
	96	PIETRA SERENA	ivory beige moss graphite	natural lappato filosega rigato bocciardato
	110	AZULCASCAIS	ivory moss graphite	natural lappato strutturato
	203	JERUSALEM	ivory vison grey	natural
	118	CELTIC	olive black	estrutturato
	126	AUSTRAL	ivory copper antracita	estrutturato
	204	JAMTLAND	ivory graphite	natural lappato
	202	DAGON	marfil beige siena vison savanna	natural lappato
	WOOD tech	134	LEGNO + SLIM	ice noce titanium
148		ROOTS	white maple oak	estrutturato
158		MENSA	savanna graphite	natural non slip
198		ISMO	marfil beige moka antracita	natural lappato
COLOUR wall tech	164	GALLERY + SLIM	white yellow lime orange blue red black	pulido satinado righe slim natural hexagon square
	188	GALLERY WALL	white lime orange blue red black	brillo mate

FORMATS  
FORMATI. FORMATOS

SPECIAL PIECES  
PEZZI SPECIALI. PIEZAS ESPECIALES



PAGE  
PAGINA

			CLASE 2 R10 natural	04
			CLASE 1 R10 natural	16
			CLASE 1 R9 natural CLASE 3 R11 corrugato	28
	slim		CLASE 1 R9 natural CLASE 2 R10 lappato	40
			CLASE 1 R9 natural	60
			CLASE 1 R9 natural / lappato	200
			CLASE 1 R9 natural CLASE 3 R10 non-slip	68
	slim		CLASE 1 R9 natural CLASE 2 R10 lappato	80
			CLASE 1 R9 natural CLASE 3 R11 filosega / rigato CLASE 2 R10 bocciardato	96
			CLASE 1 R10 natural CLASE 3 R12 strutturado	110
			CLASE 1 R9 natural	203
			CLASE 1 R9 natural	118
			CLASE 1 R9 natural	126
			CLASE 1 R9 natural	204
	Kefren Micerino		CLASE 1 R9 natural / lappato	202
	slim		CLASE 1 R10 natural	134
			CLASE 3 R11 natural	148
			CLASE 1 R9 natural CLASE 3 R11 non-slip	158
			CLASE 1 R9 natural / lappato	198
	slim		CLASE 1 R9 mate	164
				188

# RAMBLA



ENCAUSTIC



\* Rambla random natural. Content of recycled material.

## FORMATS.FORMATI.FORMATOS



30X30  
29,75x29,75 cm - 11.71"x11.71"

## SPECIAL PIECES.PEZZI SPECIALI.PIEZAS ESPECIALES



30X30 mosaico 5x5  
29,75x29,75 cm - 11.71"x11.71"



Rodapié 7,5x30  
7,3x29,75 cm - 2.92"x11.71"

## THICKNESS.SPESSORE.ESPESORES

 1 cm approx. / 0.39" approx.

## COLOURS COLORI COLORES

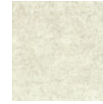

Ivory



Abyss



Alchemy



Clip

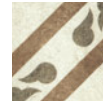

Random

## FINISHES FINITURI ACABADOS



Natural

RAMBLA

# RAMBLA **abyss**

## PLAIN TILES.BASE.BASES



**Rambla abyss natural**  
29,75x29,75 cm - 11.71"x11.71"  
G-6286

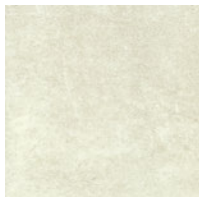

**Rambla ivory natural**  
29,75x29,75 cm - 11.71"x11.71"  
G-6286

**CLASE 2** | **R10\*\***

UNE - ENV 12633

**DCOF>0.42**

ANSI A 137.1 - 2012

\*\* For projects check technical information with our commercial network.  
Para proyectos obtenga información técnica a través de nuestra red comercial.

## SPECIAL PIECES.PEZZI SPECIALI. PIEZAS ESPECIALES



**Rambla ivory natural  
mosaico 5x5**  
29,75x29,75 cm - 11.71"x11.71"  
G-6666



**Rambla ivory natural rodapié**  
7,3x29,75 cm - 2.92"x11.71"  
G-5065





RAMBLA

Rambla Abyss Natural 29,75x29,75 cm

# RAMBLA **alchemy**

## PLAIN TILES.BASE.BASES



**Rambla alchemy natural**  
29,75x29,75 cm - 11.71"x11.71"  
G-6286



**Rambla ivory natural**  
29,75x29,75 cm - 11.71"x11.71"  
G-6286

**CLASE 2** | **R10\*\***  
UNE - ENV 12633

**DCOF>0.42**  
ANSI A 137.1 - 2012

\*\* For projects check technical information with our commercial network.  
Para proyectos obtenga información técnica a través de nuestra red comercial.

## SPECIAL PIECES.PEZZI SPECIALI. PIEZAS ESPECIALES



**Rambla ivory natural mosaico 5x5**  
29,75x29,75 cm - 11.71"x11.71"  
G-6666



**Rambla ivory natural rodapié**  
7,3x29,75 cm - 2.92"x11.71"  
G-5065





RAMBLA

Rambla Alchemy Natural 29,75x29,75 cm

# RAMBLA clip

PLAIN TILES.BASE.BASES



**Rambla clip natural**  
29,75x29,75 cm - 11.71"x11.71"  
G-6286



**Rambla ivory natural**  
29,75x29,75 cm - 11.71"x11.71"  
G-6286

**CLASE 2** | **R10\*\***  
UNE - ENV 12633

**DCOF>0.42**  
ANSI A 137.1 - 2012

\*\* For projects check technical information with our commercial network.  
Para proyectos obtenga información técnica a través de nuestra red comercial.

SPECIAL PIECES.PEZZI SPECIALI. PIEZAS ESPECIALES

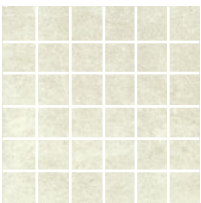

**Rambla ivory natural mosaico 5x5**  
29,75x29,75 cm - 11.71"x11.71"  
G-6666

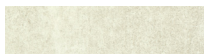

**Rambla ivory natural rodapié**  
7,3x29,75 cm - 2.92"x11.71"  
G-5065





RAMBLA

Rambla Clip Natural 29,75x29,75 cm

# RAMBLA random

## PLAIN TILES.BASE.BASES

**CLASE 2** **R10** **DCOF>0.42**  
 UNE - ENV 12633 DIN 51130 ANSI A 137.1 - 2012



**Rambla random natural\***  
 29,75x29,75 cm - 11.71"x11.71"  
**G-6286**



**Rambla ivory natural**  
 29,75x29,75 cm - 11.71"x11.71"  
**G-6286**

**\*13 DIFFERENT ALEATORY PATTERNS.**  
 \*13 DECORACIONES DIFERENTES ALEATORIAS

\*\* For projects check technical information with our commercial network.  
 \*\* Para proyectos obtenga información técnica a través de nuestra red comercial.

## SPECIAL PIECES. PEZZI SPECIALI.PIEZAS ESPECIALES

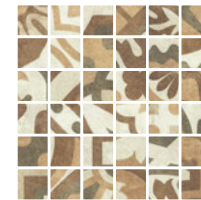

**Rambla random nat**  
**mosaico 5x5**  
 29,75x29,75 cm  
**G-6666**



**Rambla ivory natural**  
**mosaico 5x5**  
 29,75x29,75 cm - 11.71"x11.71"  
**G-6666**

















**Rambla ivory natural rodapié**  
 7,3x29,75 cm - 2.92"x11.71"  
**G-5065**



RAMBLA

Rambla Random Natural 29,75x29,75 cm

# TECHNICAL CHARACTERISTICS. CARATTERISTICHE TECNICHE. CARACTERÍSTICAS TÉCNICAS

MEASUREMENTS AND SURFACES APPEARANCE / DIMENSIONI E ASPETTO SUPERFICIALE / MEDIDAS Y ASPECTO SUPERFICIAL / MASSEN UND AUSSEHEN DER OBERFLÄCHE		STANDARD TEST METHOD METODO DELLA NORMA MÉTODO DE ENSAYO STANDARD TEST METHOD	STANDARD PRESCRIBED VALUES VALORE PRESCRITTO VALORES STANDARD NORMA STANDARDWERTE	<b>RAMBLA</b> collection
 <b>Length and width.</b> <i>Lunghezza e larghezza.</i> Longitud y anchura. Länge und Breite		ISO 10545-2	± 0,6% max.	± 0,1% *
 <b>Orthogonality.</b> <i>Ortogonalità.</i> Ortogonalidad. Rechtwinkligkeit		ISO 10545-2	± 0,6% max.	± 0,2% *
 <b>Straightness of sides.</b> <i>Rettilinearità dei lati.</i> Rectitud de lados. Kantengeradigkeit		ISO 10545-2	± 0,5% max.	± 0,2% *
 <b>Surfaces flatness.</b> <i>Planarità.</i> Planitud. Ebenföchigkeit		ISO 10545-2	± 0,5% max.	± 0,2% *
PHYSICAL PROPERTIES / PROPIETÀ FISICHE / PROPIEDADES FÍSICAS / PHYSIKALISCHE EIGENSCHAFTEN				
 <b>Water absorption.</b> <i>Assorbimento d'acqua.</i> Absorción de agua. Wasseraufnahme		ISO 10545-3	≤ 0,5%	≤ 0,1%
 <b>Breaking strength, in N.</b> <i>Carico di rottura, in N.</i> Carga de rotura, en N. Bruchlast, in N	thickness > 7,5 mm spessore > 7,5 mm grösor > 7,5 mm	ISO 10545-4	1300 N	≥ 2400 N *
 <b>Modulus of rupture.</b> <i>Resistenza alla flessione.</i> Resistencia a la flexión. Biegefestigkeit		ISO 10545-4	≥ 35 N/mm <sup>2</sup>	56 N/mm <sup>2</sup> *
 <b>Resistance to deep abrasion.</b> <i>Resistenza all'abrasione profonda.</i> Resistencia a la abrasión profunda. Tiefverschleissbeständigkeit		ISO 10545-6	≤ 175 mm <sup>3</sup>	115 mm <sup>3</sup> *
 <b>Resistance to thermal shock.</b> <i>Resistenza agli sbalzi termici.</i> Resistencia al choque térmico. Temperaturwechselbeständigkeit		ISO 10545-9	No surface defects should be visible <i>Non deve presentare difetti visibili</i> No debe presentar defectos superficiales visibles	Resistant. Resistente. Resistente
 <b>Frost resistance.</b> <i>Resistenza al gelo.</i> Resistencia a la helada. Frostbeständigkeit		ISO 10545-12	No surface defects or cracks should be visible <i>Non deve presentare difetti visibili</i> No debe presentar defectos ni grietas superficiales visibles	Frost Resistance <i>Anghiaccio</i> Resistente a la Helada
 <b>Coefficient of friction.</b> <i>Resistenza allo scivolamento.</i> Coeficiente de fricción. Rutschfestigkeit		DIN 51130 UNE - ENV 12633	WET TEST/ENSAYO EN <b>HÚMEDO</b> DRY TEST/ENSAYO EN <b>SECO</b>	<b>R10**</b> Clase I *** DCOF - ANSIA 137.1-2012 > 0.42
 <b>Colour resistance to light.</b> <i>Resistenza dei colori alla luce.</i> Resistencia del color a la luz. Lichtbeständigkeit der Farben		DIN 51094	There should be no colour variations <i>Non deve presentare difetti visibili</i> No debe presentar variaciones de color	No alterations in colour and shine <i>Non presentar alterazioni di colori e lucidità</i> No presentar variaciones de color y brillo
CHEMICAL PROPERTIES / PROPIETÀ CHIMICHE / PROPIEDADES QUÍMICAS / CHEMISCHEN EIGENSCHAFTEN				
 <b>Chemical resistance.</b> <i>Resistenza agli agenti chimici.</i> Resistencia química. Chemikalienbeständigkeit		ISO 10545-13	Resistance to household cleaning products and swimmingpools salts. <i>Resistencia a productos domésticos y sales para piscinas.</i>	Min. UB
 <b>Resistance to staining.</b> <i>Resistenza alle macchie.</i> Resistencia a las manchas. Fleckenbeständigkeit		ISO 10545-14	≥ 3	5 *

\*Natural finish. The Lab values are the average of different production consignments. For further detail information, please check with our commercial network. /

I valori dichiarati sono ottenuti da una media di prove effettuate su diverse produzioni. Per avere informazioni dettagliate consultare la rete commerciale /

Los valores declarados son el promedio obtenido a través de ensayos de diferentes producciones. Para la obtención de una información detallada consultar a la red comercial.

\*\* Tested in Natural finish. For projects check technical information with our commercial networks. /

Per progetti ottenere informazioni tecniche attraverso la nostra rete commerciale. / Para proyectos obtenga información técnica a través de nuestra red comercial.

\*\*\* Tested in Natural finish. (It depends on the consignment) Test realized in internal laboratory. / Prova effettuata in laboratorio interno. / Ensayo realizado en laboratorio interno.

\*\*\*\* Dry Test, according to document DA DB-SUA/3 (Código Técnico de la Edificación) M° de Fomento.

Ensayo realizado, según documento DA DB-SUA/3 (Código Técnico de la Edificación) M° de Fomento



RAMBLA

Rambla Random Natural 29,75x29,75 cm

# NOUVEAU



ENCAUSTIC



VINEYARD HOTEL  
Cape Town. (South Africa)



WINE BOUTIQUE  
San José. (Costa Rica)

\* Nouveau random grey natural. Content of recycled material.

## FORMATS.FORMATI.FORMATOS



30X30  
29,75x29,75 cm - 11.71"x11.71"

## SPECIAL PIECES.PEZZI SPECIALI.PIEZAS ESPECIALES



30X30 mosaico 5x5  
29,75x29,75 cm - 11.71"x11.71"



Rodapié 7,5x30  
7,3x29,75 cm - 2.92"x11.71"

## THICKNESS.SPESSORE.ESPESORES

 1 cm approx. / 0.39" approx.

## COLOURS COLORI COLORES



Ivory



Light



Dark



Random



Inox

## FINISHES FINITURI ACABADOS



Natural

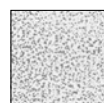

Lappato

NOUVEAU

# NOUVEAU random grey

PLAIN TILES.BASE.BASES



**Nouveau random grey natural\***

29,75x29,75 cm - 11.71"x11.71"

G-6286

**\*30 DIFFERENT ALEATORY PATTERNS.**

30 DECORACIONES DIFERENTES ALEATORIAS

**CLASE 1** | **R10\*\***

UNE - ENV 12633 | DIN 51130

**DCOF>0.42**

ANSI A 137.1 - 2012

\*\* For projects check technical information with our commercial network.  
Para proyectos obtenga información técnica a través de nuestra red comercial.



**Nouveau Ivory natural**

29,75x29,75 cm - 11.71"x11.71"

G-6286

SPECIAL PIECES.  
PEZZI SPECIALI. PIEZAS ESPECIALES



**Nouveau random grey nat  
mosaico 5x5**  
29,75x29,75 cm  
G-6666



**Nouveau ivory natural  
mosaico 5x5**  
29,75x29,75 cm - 11.71"x11.71"  
G-6666



**Nouveau ivory natural rodapié**  
7,3x29,75 cm - 2.92"x11.71"  
G-5065



Nouveau Random Grey Natural 29,75x29,75 cm

# NOUVEAU dark grey

## PLAIN TILES.BASE.BASES



**Nouveau dark grey natural**

29,75x29,75 cm - 11.71"x11.71"

G-6286



**Nouveau ivory natural**

29,75x29,75 cm - 11.71"x11.71"

G-6286

**CLASE 1**

UNE - ENV 12633

**R10\*\***

DIN 51130

**DCOF>0.42**

ANSI A 137.1 - 2012

\*\* For projects check technical information with our commercial network.

Para proyectos obtenga información técnica a través de nuestra red comercial.

## SPECIAL PIECES.PEZZI SPECIALI. PIEZAS ESPECIALES

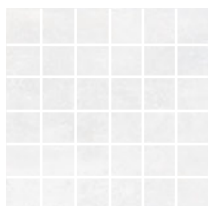

**Nouveau ivory natural  
mosaico 5x5**

29,75x29,75 cm - 11.71"x11.71"

G-6666



**Nouveau ivory natural rodapié**

7,3x29,75 cm - 2.92"x11.71"

G-5065





NOUVEAU

Nouveau Dark Grey Natural\_ Ivory Natural 29,75x29,75 cm

# NOUVEAU light grey

## PLAIN TILES.BASE.BASES



**Nouveau light grey natural**  
29,75x29,75 cm - 11.71"x11.71"  
G-6286



**Nouveau ivory natural**  
29,75x29,75 cm - 11.71"x11.71"  
G-6286

**CLASE 1**

UNE - ENV 12633

**R10\*\***

DIN 51130

**DCOF>0.42**

ANSI A 137.1 - 2012

\*\* For projects check technical information with our commercial network.  
Para proyectos obtenga información técnica a través de nuestra red comercial.

## SPECIAL PIECES.PEZZI SPECIALI. PIEZAS ESPECIALES

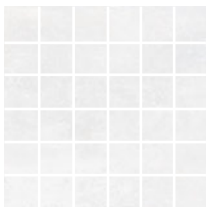

**Nouveau ivory natural mosaico 5x5**  
29,75x29,75 cm - 11.71"x11.71"  
G-6666



**Nouveau ivory natural rodapié**  
7,3x29,75 cm - 2.92"x11.71"  
G-5065





NOUVEAU

Nouveau Light Grey Natural\_Ivory Natural 29,75x29,75 cm

# NOUVEAU random inox

PLAIN TILES.BASE.BASES

CLASE 1

UNE - ENV 12633

DCOF>0.42

ANSI A 137.1 - 2012

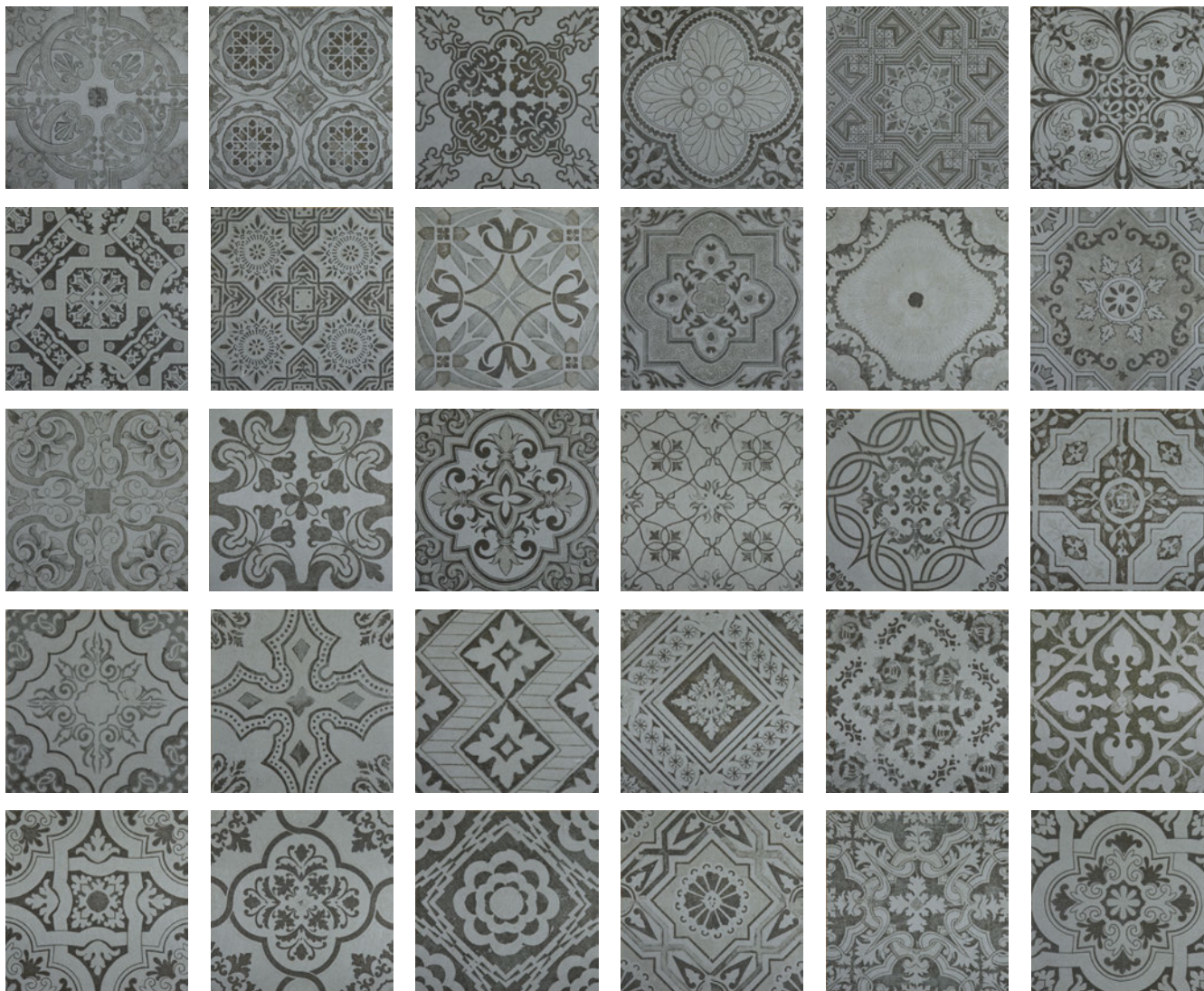

## Nouveau iandom inox lappato\*

29,75x29,75 cm - 11.71"x11.71"

6-6372















\*30 DIFFERENT ALEATORY PATTERNS.  
30 DECORACIONES DIFERENTES ALEATORIAS



NOUVEAU

Nouveau Random Inox Lappato 29,75x29,75 cm

# TECHNICAL CHARACTERISTICS. CARATTERISTICHE TECNICHE. CARACTERÍSTICAS TÉCNICAS

MEASUREMENTS AND SURFACES APPEARANCE / DIMENSIONI E ASPETTO SUPERFICIALE / MEDIDAS Y ASPECTO SUPERFICIAL / MASSEN UND AUSSEHEN DER OBERFLÄCHE		STANDARD TEST METHOD METODO DELLA NORMA MÉTODICO DE ENSAYO STANDARD TEST METHOD	STANDARD PRESCRIBED VALUES VALORE PRESCRITTO VALORES STANDARD NORMA STANDARDWERTE	NOUVEAU collection *
 <b>Length and width.</b> <i>Lunghezza e larghezza.</i> Longitud y anchura. Länge und Breite		ISO 10545-2	± 0,6% max.	± 0,1% *
 <b>Orthogonality.</b> <i>Ortogonalità.</i> Ortogonalidad. Rechtwinkligkeit		ISO 10545-2	± 0,6% max.	± 0,2% *
 <b>Straightness of sides.</b> <i>Rettilinearità dei lati.</i> Rectitud de lados. Kantengeradigkeit		ISO 10545-2	± 0,5% max.	± 0,2% *
 <b>Surfaces flatness.</b> <i>Planarità.</i> Planitud. Ebenföchigkeit		ISO 10545-2	± 0,5% max.	± 0,2% *
PHYSICAL PROPERTIES / PROPIETÀ FISICHE / PROPIEDADES FÍSICAS / PHYSIKALISCHE EIGENSCHAFTEN				
 <b>Water absorption.</b> <i>Assorbimento d'acqua.</i> Absorción de agua. Wasseraufnahme		ISO 10545-3	≤ 0,5%	≤ 0,1%
 <b>Breaking strength, in N.</b> <i>Carico di rottura, en N.</i> Carga de rotura, en N. Bruchlast, in N	thickness > 7,5 mm spessore > 7,5 mm grosor > 7,5 mm	ISO 10545-4	1300 N	≥ 2400 N *
 <b>Modulus of rupture.</b> <i>Resistenza alla flessione.</i> Resistencia a la flexión. Biegefestigkeit		ISO 10545-4	≥ 35 N/mm <sup>2</sup>	56 N/mm <sup>2</sup> *
 <b>Resistance to deep abrasion.</b> <i>Resistenza all'abrasione profonda.</i> Resistencia a la abrasión profunda. Tiefverschleissbeständigkeit		ISO 10545-6	≤ 175 mm <sup>3</sup>	115 mm <sup>3</sup> *
 <b>Resistance to thermal shock.</b> <i>Resistenza agli sbalzi termici.</i> Resistencia al choque térmico. Temperaturwechselbeständigkeit		ISO 10545-9	No surface defects should be visible <i>Non deve presentare difetti visibili</i> No debe presentar defectos superficiales visibles	Resistant. <i>Resistente. Resistente</i>
 <b>Frost resistance.</b> <i>Resistenza al gelo.</i> Resistencia a la helada. Frostbeständigkeit		ISO 10545-12	No surface defects or cracks should be visible <i>Non deve presentare difetti visibili</i> No debe presentar defectos ni grietas superficiales visibles	Frost Resistance <i>Antighiaccio</i> Resistente a la Helada
 <b>Coefficient of friction.</b> <i>Resistenza allo scivolamento.</i> Coeficiente de fricción. Rutschfestigkeit		DIN 51130 UNE - ENV 12633	WET TEST/ENSAYO EN HÚMEDO DRY TEST/ENSAYO EN SECO	<b>R10**</b> Clase I *** Clase 3 **** DCOF - ANSIA 137.1-2012 > 42
 <b>Colour resistance to light.</b> <i>Resistenza dei colori alla luce.</i> Resistencia del color a la luz. Lichtbeständigkeit der Farben		DIN 51094	There should be no colour variations <i>Non deve presentare difetti visibili</i> No debe presentar variaciones de color	No alterations in colour and shine <i>Non presenta alterazioni di colori e lucentezza</i> No presenta variaciones de color y brillo
CHEMICAL PROPERTIES / PROPIETÀ CHIMICHE / PROPIEDADES QUÍMICAS / CHEMISCHEN EIGENSCHAFTEN				
 <b>Chemical resistance.</b> <i>Resistenza agli agenti chimici.</i> Resistencia química. Chemikalienbeständigkeit		ISO 10545-13	Resistance to household cleaning products and swimming pools salts. <i>Resistencia a productos de limpieza y sales para piscinas.</i>	Min. UB
 <b>Resistance to staining.</b> <i>Resistenza alle macchie.</i> Resistencia a las manchas. Fleckenbeständigkeit		ISO 10545-14	≥ 3	5 *

\*Natural finish. The Land values are the average of different production consignments. For further detail information, please check with our commercial network. /

I valori dichiarati sono ottenuti da una media di prove effettuate su diverse produzioni. Per avere informazioni dettagliate consultare la rete commerciale /

Los valores declarados son el promedio obtenido a través de ensayos de diferentes producciones. Para la obtención de una información detallada consultar a la red comercial.

\*\* Tested in Natural finish. For projects check technical information with our commercial networks. /

Per progetti ottenere informazioni tecniche attraverso la nostra rete commerciale. / Para proyectos obtenga información técnica a través de nuestra red comercial.

\*\*\* Clase I - Tested in Natural finish. (It depends on the consignment) Test realized in internal laboratory. / Prova effettuata in laboratorio interno. / Ensayo realizado en laboratorio interno.

\*\*\*\* Dry Test, according to document DA DB-SUA/3 (Código Técnico de la Edificación) M° de Fomento. Test done in Nouveau Random Grey 30x30 on October 2014.

Ensayo realizado, según documento DA DB-SUA/3 (Código Técnico de la edificación) M° de Fomento, sobre el producto Nouveau Random Grey 30x30 a fecha octubre 2014



NOUVEAU

Nouveau Dark Grey 29,75x29,75 cm - Legno Ice 14,74x89,46 cm

# MIDLAND



STONE



\* Midland ivory natural. Content of recycled material. Contenido de material reciclado.

## FORMATS.FORMATI.FORMATOS



**60X120**  
59,55x119,3 cm - 23.45"x46.97"



**60X60**  
59,55x59,55 cm - 23.45"x23.45"



**30X60**  
29,75x59,55 cm - 11.71"x23.45"

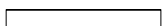

**7,5X60**  
7,3x59,55 cm - 2.87"x23.45"

## SPECIAL PIECES.PEZZI SPECIALI.PIEZAS ESPECIALES

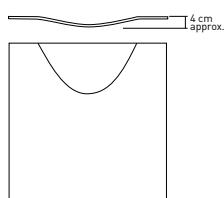

**60x120 Bag\***  
59,55x119,30 cm - 23.45"x46.96"  
**60X60 Bag\***  
59,55x59,55 cm - 23.45"x23.45"  
**30X60 Bag\***  
29,75x59,55 cm - 11.71"x23.45"

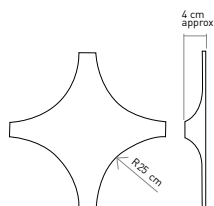

**60X60 Star\***  
59,55x58,88 cm - 23.45"x23.18"

+ INFO pag. 210

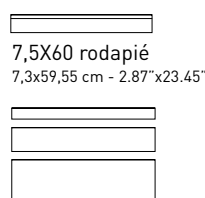

**7,5X60 rodapié**  
7,3x59,55 cm - 2.87"x23.45"

**15X60 - 10X60 - 5X60 multiformat natural\***  
14,75x59,55 cm - 5.87"x23.45"  
9,72x59,55 cm - 3.83"x 23.45"  
4,84x59,55 cm - 1.90"x23.45"

\*The box contains 5 pieces from each of the formats.  
cada caja contiene 5 piezas de cada formato.



**30X30 mosaico 5x5**  
29,75x29,75 cm - 11.71"x11.71"



**30X30 mosaico 5x5 Multex**  
29,75x29,75 cm - 11.71"x11.71"



**30X30 mosaico 3D**  
28,5x28,5 cm 11.22"x11.22"

## THICKNESS.SPESSORE.ESPESORES

≡ 0,74 cm / 0.29" approx.

## COLOURS COLORI COLORES

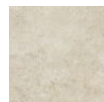

**Ivory**

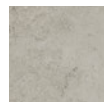

**Grey**

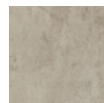

**Vison**

## FINISHES FINITURI ACABADOS



**Natural**

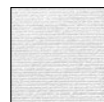

**Corrugato**

## PLAIN TILES.BASE.BASES



**Midland ivory natural**  
119,30x 59,55 cm - 46.96" x 23.45"  
G-6372



**Midland ivory natural**  
59,55 x 59,55 cm - 23.45" x 23.45"  
G-6224



**Midland ivory natural**  
29,75 x 59,55 cm - 11.71" x 23.45"  
G-6194

Natural	<b>CLASE 1</b>	<b>R9</b>
	UNE - ENV 12633	DIN 51130
	<b>DCOF&gt;0.42</b>	
	ANSI A 137.1 - 2012	
Corrugato	<b>CLASE 3</b>	<b>R11</b>
	UNE - ENV 12633	DIN 51130

## SPECIAL PIECES. PEZZI SPECIALI. PIEZAS ESPECIALES



**Midland ivory corrugato**  
29,75 x 59,55 cm - 11.71" x 23.45"  
G-6234



**Midland ivory natural multiformato**  
4,84x59,55\_9,72x59,55\_14,75x59,55 cm  
1.90"x23.45"\_3.82"x23.45"\_5.80"x23.45"  
G-6346



**Midland ivory rodapié-60**  
7,3 x 59,55 cm - 2.87" x 23.45"  
G-5091



**Midland ivory natural lista 60**  
7,3 x 59,55 cm - 2.87" x 23.45"  
G-5087

\* Midland mosaico 3D contains approximately 12,3 pieces/m<sup>2</sup>  
\* Midland mosaico 3D contiene aproximadamente 12,3 piezas/m<sup>2</sup>



MIDLAND

Midland Ivory Natural 59,55x119,30 cm\_Midland Ivory Mosaico 3D 28,5x28,5 cm

## PLAIN TILES.BASE.BASES



**Midland grey natural**  
119,30x 59,55 cm - 46.96" x 23.45"  
G-6372



**Midland grey natural**  
59,55 x 59,55 cm - 23.45" x 23.45"  
G-6224



**Midland grey natural**  
29,75 x 59,55 cm - 11.71" x 23.45"  
G-6194

Natural	<b>CLASE 1</b>	<b>R9</b>
	UNE - ENV 12633	DIN 51130
	<b>DCOF&gt;0.42</b>	ANSI A 137.1 - 2012
Corrugato	<b>CLASE 3</b>	<b>R11</b>
	UNE - ENV 12633	DIN 51130

## SPECIAL PIECES. PEZZI SPECIALI. PIEZAS ESPECIALES



**Midland grey corrugato**  
29,75 x 59,55 cm - 11.71" x 23.45"  
G-6234



**Midland grey natural multiformato**  
4,84x59,55\_9,72x59,55\_14,75x59,55 cm  
1.90"x23.45" \_3.82"x23.45" \_5.80"x23.45"  
G-6346

\* Midland mosaico 3D contains approximately 12,3 pieces/m<sup>2</sup>  
\* Midland mosaico 3D contiene aproximadamente 12,3 piezas/m<sup>2</sup>



**Midland grey rodapié-60**  
7,3 x 59,55 cm - 2.87" x 23.45"  
G-5091



**Midland grey natural lista 60**  
7,3 x 59,55 cm - 2.87" x 23.45"  
G-5087



MIDLAND

Midland Grey Natural 59,55x119,30 cm

## PLAIN TILES.BASE.BASES



**Midland vison natural**  
119,30x 59,55 cm - 46.96" x 23.45"  
**G-6372**



**Midland vison natural**  
59,55 x 59,55 cm - 23.45" x 23.45"  
**G-6224**



**Midland vison natural**  
29,75 x 59,55 cm - 11.71" x 23.45"  
**G-6194**

Natural	<b>CLASE 1</b>	<b>R9</b>
	UNE - ENV 12633	DIN 51130
	<b>DCOF&gt;0.42</b>	ANSI A 137.1 - 2012
Corrugato	<b>CLASE 3</b>	<b>R11</b>
	UNE - ENV 12633	DIN 51130

## SPECIAL PIECES. PEZZI SPECIALI. PIEZAS ESPECIALES



**Midland vison corrugato**  
29,75 x 59,55 cm - 11.71" x 23.45"  
**G-6234**



**Midland vison natural multiformato**  
4,84x59,55\_9,72x59,55\_14,75x59,55 cm  
1.90"x23.45" \_3.82"x23.45" \_5.80"x23.45"  
**G-6346**

\* Midland mosaico 3D contains approximately 12'3 pieces/m<sup>2</sup>  
\* Midland mosaico 3D contiene aproximadamente 12,3 piezas/m<sup>2</sup>



**Midland vison rodapié-60**  
7,3 x 59,55 cm - 2.87" x 23.45"  
**G-5091**

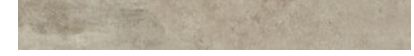

**Midland vison natural lista 60**  
7,3 x 59,55 cm - 2.87" x 23.45"  
**G-5087**



MIDLAND

Midland Vison Natural 59,55x59,55 cm

# MIDLAND

## SPECIAL PIECES.

PEZZI SPECIALI. PIEZAS ESPECIALES

Natural	<b>CLASE 1</b>	<b>R9</b>
	UNE - ENV 12633	DIN 51130
	<b>DCOF&gt;0.42</b>	
	ANSI A 137.1 - 2012	
Corrugato	<b>CLASE 3</b>	<b>R11</b>
	UNE - ENV 12633	DIN 51130



**Midland grey mosaico 3D\***  
28,5x28,5 - 11.22" x 11.22"  
G-5187



**Midland grey-gold mos. 3D**  
28,5x28,5 - 11.22" x 11.22"  
G-5211



**Midland grey-silver mos. 3D**  
28,5x28,5 - 11.22" x 11.22"  
G-5211



**Midland vison mosaico 3D\***  
28,5x28,5 - 11.22" x 11.22"  
G-5187



**Midland vison-gold mos. 3D**  
28,5x28,5 - 11.22" x 11.22"  
G-5211

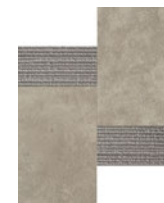

**Midland vison-silver mos. 3D**  
28,5x28,5 - 11.22" x 11.22"  
G-5211

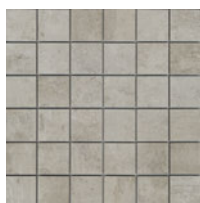

**Midland grey mosaico 5x5**  
29,75x29,75 cm - 11.71" x 11.71"  
G-6644

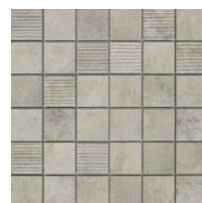

**Midland grey mosaico 5x5**  
29,75x29,75 cm - 11.71" x 11.71"  
G-6666

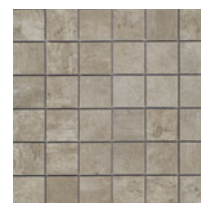

**Midland vison mosaico 5x5**  
29,75x29,75 cm - 11.71" x 11.71"  
G-6644

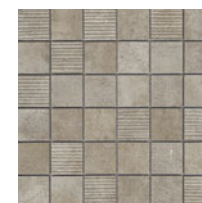

**Midland vison mosaico 5x5**  
29,75x29,75 cm - 11.71" x 11.71"  
G-6666



**Midland ivory mosaico 3D\***  
28,5x28,5 - 11.22" x 11.22"  
G-5187



**Midland ivory-gold mos. 3D**  
28,5x28,5 - 11.22" x 11.22"  
G-5211



**Midland ivory-silver mos. 3D**  
28,5x28,5 - 11.22" x 11.22"  
G-5211



**Midland ivory mosaico 5x5**  
29,75x29,75 cm - 11.71" x 11.71"  
G-6644



**Midland ivory mosaico 5x5**  
29,75x29,75 cm - 11.71" x 11.71"  
G-6666

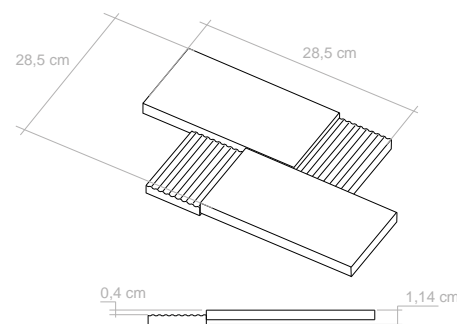

Physical Vapor Deposition (PVD)

Pvd is a field in the application of nanotechnology. The process consists of depositing layers of atoms, inside a vacuum chamber, to a solid surface. The layering is produced by the condensation of a vaporized metal (such as gold, titanium, platinum etc.) over the selected surface. Advantages: High resistance to abrasion and scratches; much higher than metals applied by firing. As a general rule, any non-aggressive, pH neutral product have to be used. Do not mix pieces from different lots.

El PVD es uno de los campos de aplicación de la nanotecnología. El proceso consiste en depositar capas de átomos, en una cámara de alto vacío, sobre una superficie sólida. El recubrimiento se produce por la condensación de un metal vaporizado, oro, titanio, platino, etc., sobre el material a recubrir. Ventajas: Mayor resistencia al rayado y a la abrasión que los metales aplicados por cocción. Para la limpieza de estos materiales deben utilizarse productos no agresivos con pH neutro. No mezclar piezas de diferentes lotes.

SPECIAL PIECES.  
PEZZI SPECIALI. PIEZAS ESPECIALES



**Midland gold corrugato lappato**  
29,75 x 59,55 cm - 11.71" x 23.45"  
G-5401



**Midland silver corrugato lappato**  
29,75 x 59,55 cm - 11.71" x 23.45"  
G-5401



**Midland copper corrugato lappato**  
29,75 x 59,55 cm - 11.71" x 23.45"  
G-5431

STEPS.  
GRADINI.PELDAÑOS















SIMPLE 

			natural
peldaño simple-120	(60x120 cm)		5519
peldaño simple	(60x60 cm)		5281
peldaño simple-60	(30x60 cm)		5171
peldaño simple-60 Corrugato	(30x60 cm)		5171
peldaño Ang	(60x60 cm)		5299
peldaño Ang	(30x60 cm)		5187
peldaño Ang Corrugato	(30x60 cm)		5187

GRADONE 

			natural
peldaño Gradone.-120	(60x120 cm)		5795
peldaño Gradone	(60x60 cm)		5559
peldaño Gradone-60	(30x60 cm)		5559
peldaño Grad.-60 Corrugato	(30x60 cm)		5559
peldaño Grad.Ang	(60x120 cm)		5815
peldaño Grad.Ang	(60x60 cm)		5609
peldaño Grad.Ang	(30x60 cm)		5609
peldaño Grad.Ang Corrug.	(30x60 cm)		5609

# TECHNICAL CHARACTERISTICS. CARATTERÍSTICAS TÉCNICAS

MEASUREMENTS AND SURFACES APPEARANCE MEDIDAS Y ASPECTO SUPERFICIAL		STANDARD TEST METHOD STANDARD TEST METHOD	STANDARD PRESCRIBED VALUES STANDARDWERTE	MIDLAND collection 7mm
	<b>Length and width.</b> Lunghezza e larghezza. Longitud y anchura. Länge und Breite	ISO 10545-2	± 0,6% max.	± 0,1%*
	<b>Orthogonality.</b> Ortogonalità. Ortogonalidad. Rechtwinkligkeit	ISO 10545-2	± 0,6% max.	± 0,2%*
	<b>Straightness of sides.</b> Rettilinearità dei lati. Rectitud de lados. Kantengeradigkeit	ISO 10545-2	± 0,5% max.	± 0,2%*
	<b>Surfaces flatness.</b> Planarità. Planitud. Ebenflächigkeit	ISO 10545-2	± 0,5% max.	± 0,2%*
PHYSICAL PROPERTIES / PROPIEDADES FÍSICAS				
	<b>Water absorption.</b> Assorbimento d' acqua. Absorción de agua. Wasseraufnahme	ISO 10545-3	≤ 0,5%	0,1%
	<b>Breaking strength, in N.</b> Carico di rottura, en N. Carga de rotura, en N. Bruchlast, in N	ISO 10545-4	≥ 700 N	1500 N*
	<b>Modulus of rupture</b> Resistenza alla flessione. Resistencia a la flexión. Biegefestigkeit	ISO 10545-4	≥ 35 N/mm <sup>2</sup>	45 N/mm <sup>2</sup> *
	<b>Resistance to deep abrasion.</b> Resistenza all' abrasione profonda. Resistencia a la abrasión profunda. Tiefverschleissbeständigkeit	ISO 10545-6	≤ 175 mm <sup>3</sup>	116 mm <sup>3</sup> *
	<b>Resistance to thermal shock.</b> Resistenza agli sbalzi termici. Resistencia al choque térmico. Temperaturwechselbeständigkeit	ISO 10545-9	No surface defects should be visible Non deve presentare difetti visibili No debe presentar defectos superficiales visibles	Resistant. Resistente. Resistente
	<b>Frost resistance.</b> Resistenza al gelo. Resistencia a la helada. Frostbeständigkeit	ISO 10545-12	No surface defects or cracks should be visible Non deve presentare difetti visibili No debe presentar defectos ni grietas superficiales visibles	Frost Resistant Antighiaccio Resistente a la Helada
	<b>Coefficient of friction.</b> Resistenza allo scivolamento. Coeficiente de fricción. Rutschfestigkeit	UNE - ENV 12633	WET TEST / ENSAYO EN HÚMEDO DRY TEST / ENSAYO EN SECO	CLASE 1 ** CLASE 3 ** CLASE 3 *** DCOF - ANSIA 137.1-2012 > 42
	<b>Colour resistance to light.</b> Resistenza dei colori alla luce. Resistencia del color a la luz. Lichtbeständigkeit der Farben	DIN 51094	There should be no colour variations Non deve presentare difetti visibili No debe presentar variaciones de color	No alterations in colour and shine Non presenta alterazioni di colori e lucentezza No presenta variaciones de color y brillo
CHEMICAL PROPERTIES / PROPIEDADES QUÍMICAS				
	<b>Chemical resistance.</b> Resistenza agli agenti chimici. Resistencia química. Chemikalienbeständigkeit	ISO 10545-13	Resistance to household cleaning products and swimmingpools salts. Resistencia a productos domésticos y sales para piscinas.	Min. UB
	<b>Resistance to staining.</b> Resistenza alle macchie. Resistencia a las manchas. Fleckenbeständigkeit	ISO 10545-14	≥ 3	5

\* The Land values are the average of different production consignments. For further detail information, please check with our commercial network.  
Los valores declarados son el promedio obtenido a través de ensayos de diferentes producciones. Para la obtención de una información detallada consultar a la red comercial.  
For projects check technical information with our commercial networks. / Para proyectos obtenga información técnica a través de nuestra red comercial.

\*\* Class 1 - Tested in MIDLAND Gey Natural 30x60 (It depends on the consignment) Test realized in internal laboratory on September 2015.  
Clase 1 - Sobre el MIDLAND Grey Natural 30x60 .Ensayo realizado en laboratorio interno en Septiembre 2015.  
Class 3 - Tested in MIDLAND Gey Corrugato 30x60 (It depends on the consignment) Test realized in internal laboratory Grey Corrugato 30x60 on September 2015.  
Clase 3 - Sobre el MIDLAND Grey Corrugato 30x60 .Ensayo realizado en laboratorio interno en Septiembre 2015.  
Class 1 - Tested in MIDLAND Grey Natural 30x60 (It depends on the consignment) Test realized in internal laboratory Grey Corrugato 30x60 on October 2014.  
Clase 1 - Sobre el MIDLAND Grey Natural 30x60 .Ensayo realizado en laboratorio

\*\*\* Dry Test, according to document DA DB-SUA/3 (Código Técnico de la Edificación) M<sup>o</sup> de Fomento. Test done in MIDLAND Grey Corrugato 30x60 on October 2015.  
Ensayo en seco, realizado según documento DA DB-SUA/3 (Código Técnico de la edificación) M<sup>o</sup> de Fomento, sobre el producto MIDLAND Grey Corrugato 30x60 a fecha octubre 2015

# 3Dimensional

SPECIAL PIECES.  
PEZZI SPECIALI. PIEZAS ESPECIALES

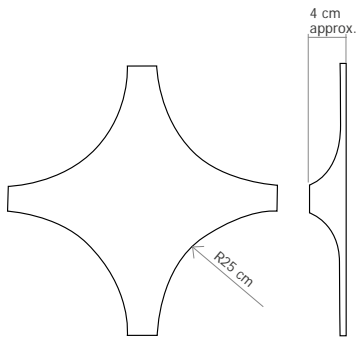

## STAR\*

59,55x58,88 cm

- Midland Star 59,55x58,88 cm **G-5599**

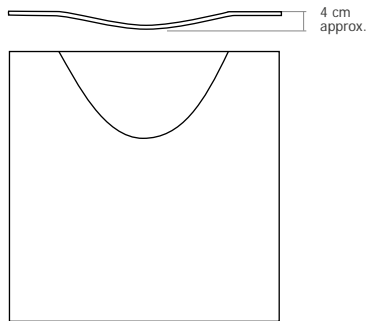

## BAG\*

59,55x119,30 cm / 59,55x59,55 cm / 29,75x59,55 cm

- Midland Bag 59,55x119,30 cm \* **G-5735**
- Midland Bag 59,55x59,55 cm \* **G-5449**
- Midland Bag 29,75x59,55 cm \* **G-5299**

\* Available in all colours from Midland collection.  
Disponible en todos los colores de la colección Midland.

This is a natural product made through a handmade process, therefore, its possible shade or size variations must be considered as typical features of the material and they will not be admitted in a claim.

Este es un producto natural fabricado artesanalmente, por lo que posibles variaciones de tono o dimensión deben considerarse propias del material y no será objeto de reclamación.

• INFO pag. 208

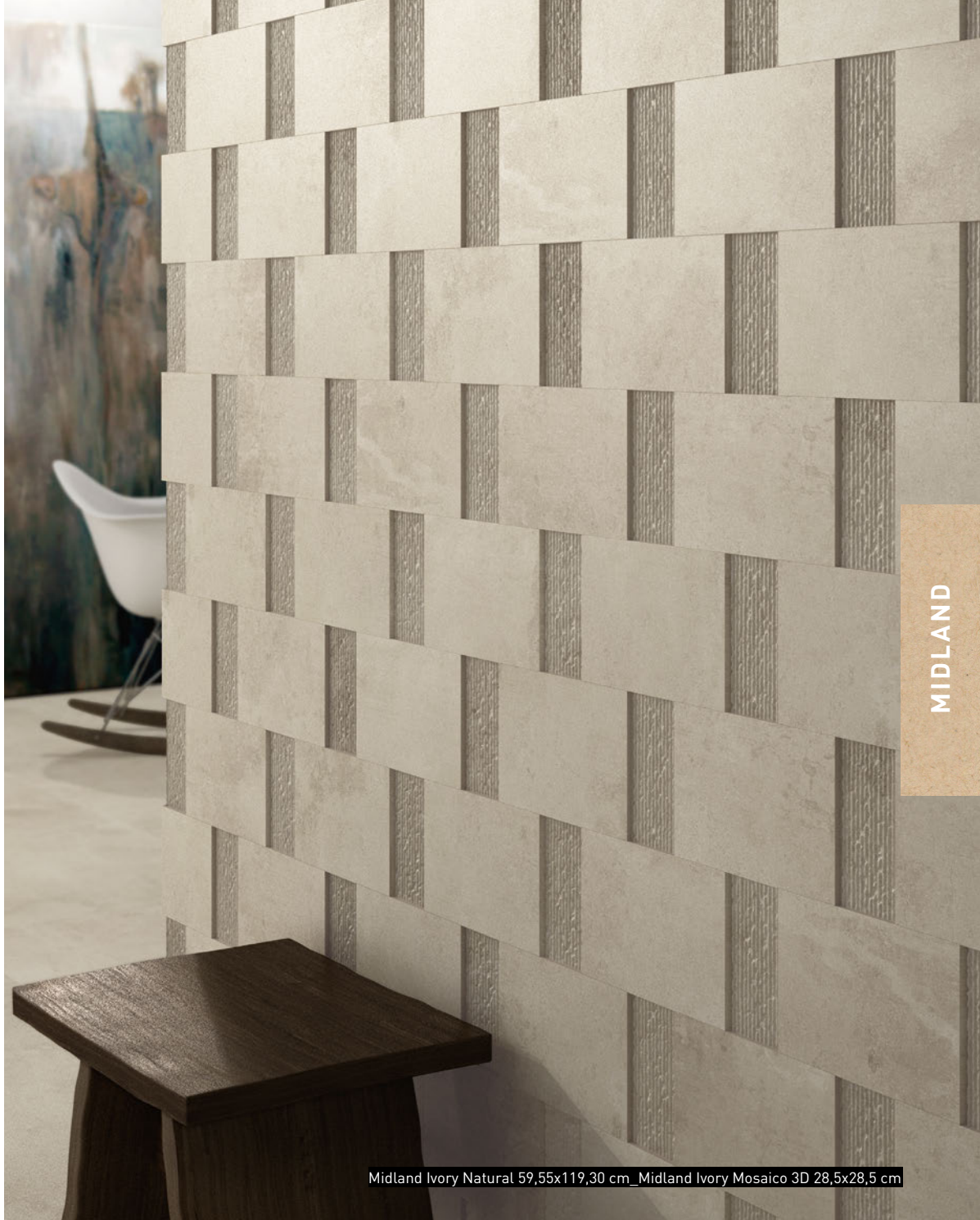

MIDLAND

Midland Ivory Natural 59,55x119,30 cm\_Midland Ivory Mosaico 3D 28,5x28,5 cm

# PORTLAND



CONCRETE

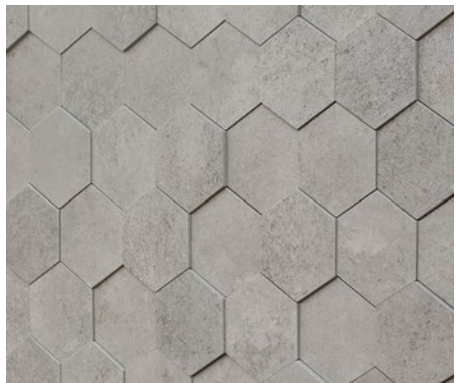

\* Portland ivory natural. Content of recycled material.

## FORMATS.FORMATI.FORMATOS

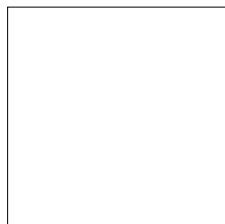

**90X90**  
89,46x89,46 cm - 35.22"x35.22"



**60X60**  
59,55x59,55 cm - 23.45"x23.45"

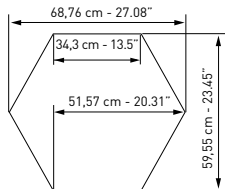

**Hexagonal**  
59,55x51,57 cm 23.45"x20.31"



**30X60**  
29,75x59,55 cm - 11.71"x23.45"

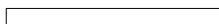

**7,5X90**  
7,3x89,46 cm - 2.87"x35.22"

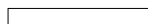

**7,5X60**  
7,3x59,55 cm - 2.87"x23.45"

## SPECIAL PIECES.PEZZI SPECIALI.PIEZAS ESPECIALES

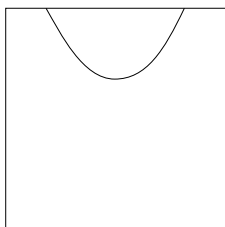

**90X90 Bag\***  
89,46x89,46 cm - 35.22"x35.22"  
**60X60 Bag\***  
59,55x59,55 cm - 23.45"x23.45"

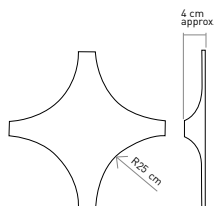

**60X60 Star\***  
59,55x58,88 cm - 23.45"x23.18"  
+ INFO pag. 210

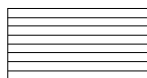

**30X60 preincisión 3,5x60**  
29,75x59,55 cm - 11.71"x23.45"



**30X30 mosaico 3,5x3,5**  
29,75x29,75 cm - 11.71"x11.71"



**27,20X23,50 mosaico hexagonal 3D**  
27,20x23,50 cm - 10.71"x9.29"



**7,5X90 rodapié**  
7,3x89,46 cm - 2.87"x35.22"

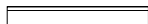

**7,5X60 rodapié**  
7,3x59,55 cm - 2.87"x23.45"

## THICKNESS.SPESORE.ESPESORES

- ≡ 1,19 cm / 0.47" approx.
- ≡ 1,03 cm / 0.40" approx.

90x90 cm FORMAT  
60x60 cm / 30x60 cm FORMATS

## COLOURS COLORI COLORES

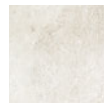

**Ivory**

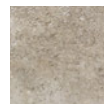

**Vison**

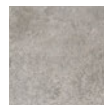

**Grey**

## FINISHES FINITURI ACABADOS



**Natural**

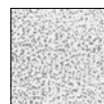

**Lappato**

PORTLAND

# PORTLAND ivory

## PLAIN TILES.BASE.BASES



### Portland ivory natural

89,46 x 89,46 cm - 35.22" x 35.22"

G-6526



### Portland ivory natural listelo

7,3 x 89,46 cm - 2.87" x 35.22"

G-5155



### Portland ivory natural / lappato listelo

7,3 x 59,55 cm - 2.87" x 23.45"

G-5087 / 5091

### Portland lappato

**CLASE 2**

UNE - ENV 12633

**R10**

DIN 51130

### Portland natural

**CLASE 1**

UNE - ENV 12633

**DCOF>0.42**

ANSI A 137.1 - 2012



### Portland ivory natural / lappato

59,55 x 59,55 cm - 23.45" x 23.45"

G-6286 / 6330

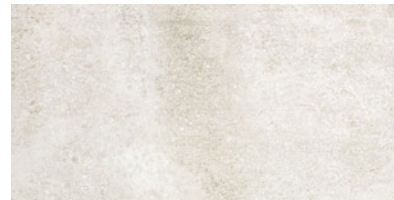

### Portland ivory natural / lappato

29,75 x 59,55 cm - 11.71" x 23.45"

G-6218 / 6254

## COMPLEMENTS.COMPLEMENTI. COMPLEMENTOS



### Byte white / moss / red / black lista 60\*

1,5 x 59,55 cm - 0.59" x 23.45"

G-5100

### Fusion natural lista 60\*

1 x 59,55 cm - 0.39" x 23.45"

G-5049

### Fusion graffiato lista 60

1,5 x 59,55 cm - 0.59" x 23.45"

G-5069

\* recommended only for walls



### Portland ivory lappato hexagonal

59,55 x 51,57 cm - 23.45" x 20.31"

G-6478

\* 3 mm joint are recommended for hexagonal sizes.

Para formatos hexagonales se recomienda una junta de separación de 3 mm.

## STEPS.GRADINI.PELDAÑOS

		natural	lappato
SIMPLE	peldaño simple-30 [30x60 cm]	5171	5171
	peldaño simple-60 [30x60 cm]	5171	5171
	peldaño simple áng. [30x60 cm]	5187	5187
	peldaño simple-60 [60x60 cm]	5281	5281
	peldaño simple áng. [60x60 cm]	5299	5299
	peldaño simple hexagonal	-	5355
GRADONE	peldaño simple 2 hexagonal	-	5281
	peldaño simple-90 [90x90 cm]	5585	-
	peldaño simple áng. [90x90 cm]	5609	-
	peldaño grad-30 [30x60 cm]	5559	5559
	peldaño grad-60 [30x60 cm]	5559	5559
	peldaño grad. áng [30x60 cm]	5609	5609
STEP	peldaño grad-60 [60x60 cm]	5559	5559
	peldaño grad. áng [60x60 cm]	5609	5609
	peldaño grad. hexagonal	-	5543
	peldaño grad. 2 hexagonal	-	5559
	peldaño grad. 90 [90x90 cm]	5779	-
	peldaño grad. áng. [90x90 cm]	5829	-
STEP	step-60 [30x60 cm]	5559	5559
	step 90 [90x90 cm]	5779	-

+ INFO pag. 207.

SPECIAL PIECES. PEZZI SPECIALI. PIEZAS ESPECIALES



**Portland ivory lappato preicisión 3,5x60**  
29,75 x 59,55 cm - 11.71" x 23.45"  
G-6486



**Portland ivory natural mosaico 3,5x3,5**  
29,75 x 29,75 cm - 11.71" x 11.71"  
G-6756

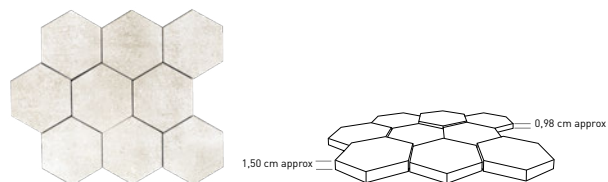

**Portland ivory lappato mosaico hexagonal 3D**  
27,20 x 23,50 cm - 10.71" x 9.29"  
G-5211



**Portland ivory natural rodapié 90**  
7,3 x 89,46 cm - 2.87" x 35.22"  
G-5163

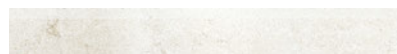

**Portland ivory natural / lappato rodapié 60**  
7,3 x 59,55 cm - 2.87" x 23.45"  
G-5097 / G-5100



Portland Ivory Lappato Hexagonal 59,55x51,57 cm

# PORTLAND grey

## PLAIN TILES.BASE.BASES



**Portland grey natural**  
89,46 x 89,46 cm - 35.22" x 35.22"  
G-6526

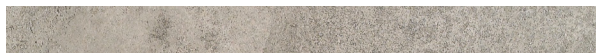

**Portland grey natural listelo**  
7,3 x 89,46 cm - 2.87" x 35.22"  
G-5155



**Portland grey natural / lappato listelo**  
7,3 x 59,55 cm - 2.87" x 23.45"  
G-5087 / 5091

**Portland lappato** **CLASE 2** **R10**  
UNE - ENV 12633 DIN 51130

**Portland natural** **CLASE 1** **DCOF>0.42**  
UNE - ENV 12633 ANSI A 137.1 - 2012



**Portland grey natural / lappato**  
59,55 x 59,55 cm - 23.45" x 23.45"  
G-6286 / 6330

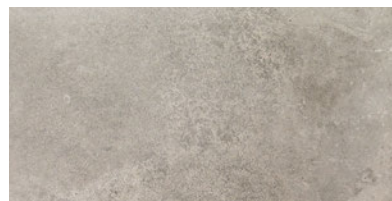

**Portland grey natural / lappato**  
29,75 x 59,55 cm - 11.71" x 23.45"  
G-6218 / 6254

## COMPLEMENTS.COMPLEMENTI. COMPLEMENTOS

**Byte white / moss / red / black lista 60\***  
1,5 x 59,55 cm - 0.59" x 23.45" G-5100

**Fusion natural lista 60\***  
1 x 59,55 cm - 0.39" x 23.45" G-5049

**Fusion graffiato lista 60**  
1,5 x 59,55 cm - 0.59" x 23.45" G-5069

\* recommended only for walls



**Portland grey lappato hexagonal**  
59,55 x 51,57 cm - 23.45" x 20.31"  
G-6478

\* 3 mm joint are recommended for hexagonal sizes.  
Para formatos hexagonales se recomienda una junta de separación de 3 mm.

## STEPS.GRADINI.PELDAÑOS

		natural	lappato
SIMPLE	pedaño simple-30 (30x60 cm)	5171	5171
	pedaño simple-60 (30x60 cm)	5171	5171
	pedaño simple áng. (30x60 cm)	5187	5187
	pedaño simple-60 (60x60 cm)	5281	5281
	pedaño simple áng. (60x60 cm)	5299	5299
	pedaño simple hexagonal	-	5355
GRADONE	pedaño simple 2 hexagonal	-	5281
	pedaño simple-90 (90x90 cm)	5585	-
	pedaño simple áng. (90x90 cm)	5609	-
	pedaño grad-30 (30x60 cm)	5559	5559
	pedaño grad-60 (30x60 cm)	5559	5559
	pedaño grad. áng (30x60 cm)	5609	5609
STEP	pedaño grad-60 (60x60 cm)	5609	5609
	pedaño grad. hexagonal	-	5543
	pedaño grad. 2 hexagonal	-	5559
	pedaño grad. 90 (90x90 cm)	5779	-
	pedaño grad. áng. (90x90 cm)	5829	-
	step-60 (30x60 cm)	5559	5559
step 90 (90x90 cm)	5779	-	

+ INFO pag. 207.

SPECIAL PIECES. PEZZI SPECIALI. PIEZAS ESPECIALES



**Portland grey lappato preincisión 3,5x60**  
29,75 x 59,55 cm - 11.71" x 23.45"  
G-6486

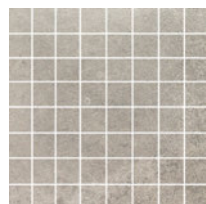

**Portland grey natural mosaico 3,5x3,5**  
29,75 x 29,75 cm - 11.71" x 11.71"  
G-6756

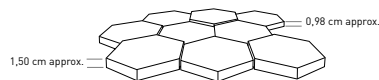

**Portland grey lappato mosaico hexagonal 3D**  
27,20 x 23,50 cm - 10.71" x 9.29"  
G-5211



**Portland grey natural rodapié 90**  
7,3 x 89,46 cm - 2.87" x 35.22"  
G-5163



**Portland grey natural / lappato rodapié 60**  
7,3 x 59,55 cm - 2.87" x 23.45"  
G-5097 / G-5100



Portland Grey Natural 59,55x59,55 cm

IBIS | PRADO HOTEL  
Madrid. (SPAIN)

# PORTLAND **vison**

## PLAIN TILES.BASE.BASES



**Portland vison natural**  
89,46 x 89,46 cm - 35.22" x 35.22"  
G-6526



**Portland vison natural listelo**  
7,3 x 89,46 cm - 2.87" x 35.22"  
G-5155

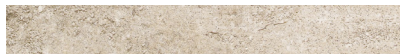

**Portland vison natural / lappato listelo**  
7,3 x 59,55 cm - 2.87" x 23.45"  
G-5087 / 5091

**Portland lappato** **CLASE 2** **R10**  
UNE - ENV 12633 DIN 51130

**Portland natural** **CLASE 1** **DCOF>0.42**  
UNE - ENV 12633 ANSI A 137.1 - 2012



**Portland vison natural / lappato**  
59,55 x 59,55 cm - 23.45" x 23.45"  
G-6286 / 6330

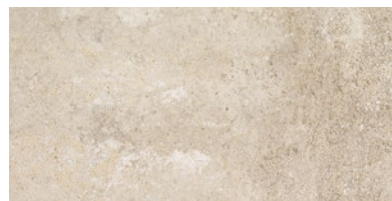

**Portland vison natural / lappato**  
29,75 x 59,55 cm - 11.71" x 23.45"  
G-6218 / 6254

## COMPLEMENTS.COMPLEMENTI. COMPLEMENTOS

**Byte white / moss / red / black lista 60\***  
1,5 x 59,55 cm - 0.59" x 23.45" G-5100

**Fusion natural lista 60\***  
1 x 59,55 cm - 0.39" x 23.45" G-5049

**Fusion graffiato lista 60**  
1,5 x 59,55 cm - 0.59" x 23.45" G-5069

\* recommended only for walls



**Portland vison lappato hexagonal**  
59,55 x 51,57 cm - 23.45" x 20.31"  
G-6478

\* 3 mm joint are recommended for hexagonal sizes.  
Para formatos hexagonales se recomienda una junta de separación de 3 mm.

## STEPS.GRADINI.PELDAÑOS

		natural	lappato
SIMPLE	peldaño simple-30 [30x60 cm]	5171	5171
	peldaño simple-60 [30x60 cm]	5171	5171
	peldaño simple áng. [30x60 cm]	5187	5187
	peldaño simple-60 [60x60 cm]	5281	5281
	peldaño simple áng. [60x60 cm]	5299	5299
	peldaño simple hexagonal	-	5355
GRADONE	peldaño simple 2 hexagonal	-	5281
	peldaño simple-90 [90x90 cm]	5585	-
	peldaño simple áng. [90x90 cm]	5609	-
	peldaño grad-30 [30x60 cm]	5559	5559
	peldaño grad-60 [30x60 cm]	5559	5559
	peldaño grad. áng [30x60 cm]	5609	5609
STEP	peldaño grad-60 [60x60 cm]	5559	5559
	peldaño grad. áng [60x60 cm]	5609	5609
	peldaño grad. hexagonal	-	5543
	peldaño grad. 2 hexagonal	-	5559
	peldaño grad. 90 [90x90 cm]	5779	-
	peldaño grad. áng. [90x90 cm]	5829	-
STEP	step-60 [30x60 cm]	5559	5559
	step 90 [90x90 cm]	5779	-

+ INFO pag. 207.

## SPECIAL PIECES. PEZZI SPECIALI. PIEZAS ESPECIALES



**Portland vison lappato preincisión 3,5x60**  
29,75 x 59,55 cm - 11.71" x 23.45"  
G-6486



**Portland vison natural mosaico 3,5x3,5**  
29,75 x 29,75 cm - 11.71" x 11.71"  
G-6756

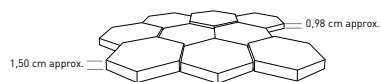

**Portland vison lappato mosaico hexagonal 3D**  
27,20 x 23,50 cm - 10.71" x 9.29"  
G-5211



**Portland vison natural rodapié 90**  
7,3 x 89,46 cm - 2.87" x 35.22"  
G-5163





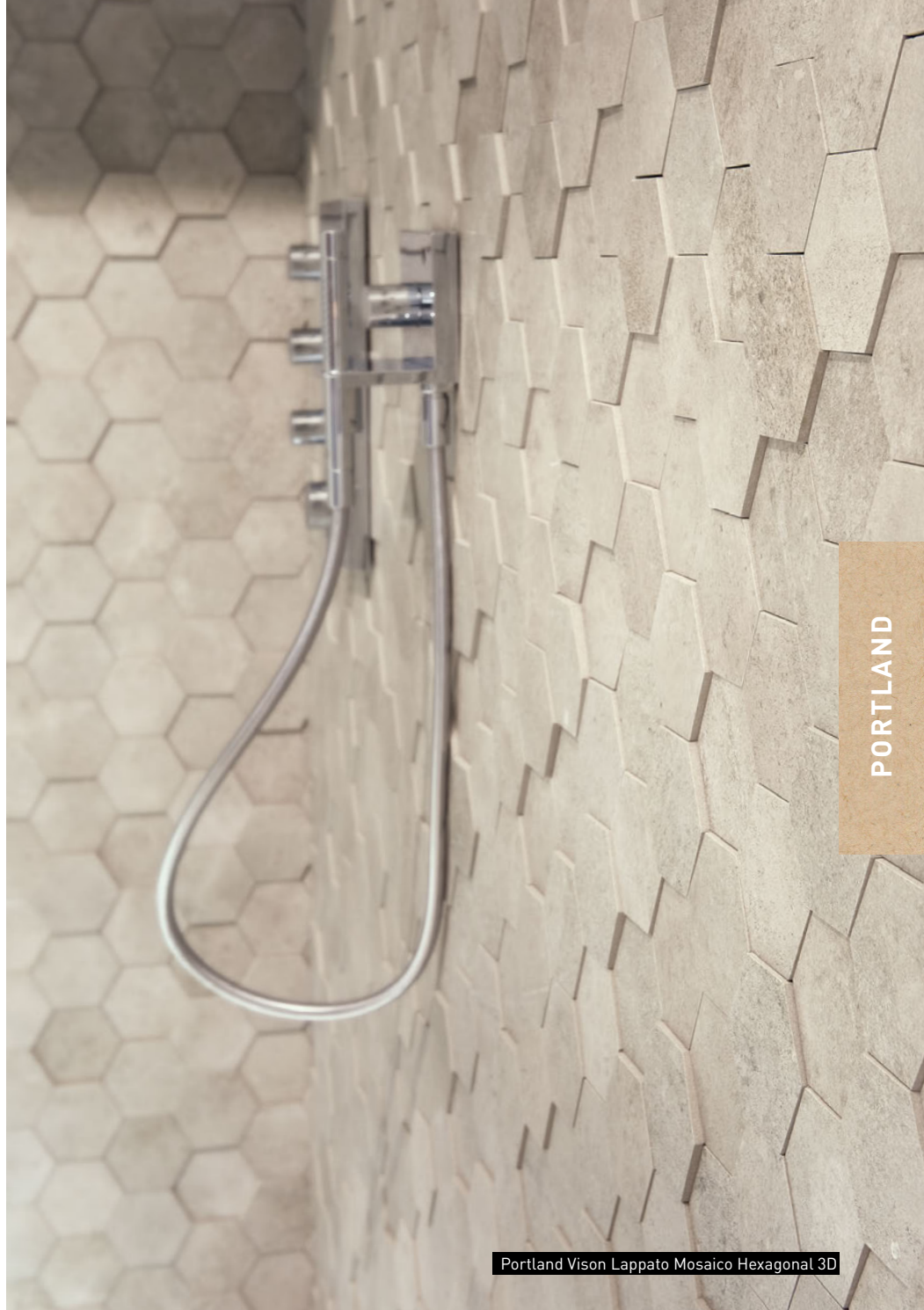











**Portland vison natural / lappato rodapié 60**  
7,3 x 59,55 cm - 2.87" x 23.45"  
G-5097 / G-5100



PORTLAND

Portland Vison Lappato Mosaico Hexagonal 3D

# TECHNICAL CHARACTERISTICS. CARATTERISTICHE TECNICHE. CARACTERÍSTICAS TÉCNICAS

MEASUREMENTS AND SURFACES APPEARANCE / DIMENSIONI E ASPETTO SUPERFICIALE / MEDIDAS Y ASPECTO SUPERFICIAL / MASSEN UND AUSSEHEN DER OBERFLÄCHE		STANDARD TEST METHOD METODO DELLA NORMA METODO DE ENSAYO STANDARD TEST METHOD	STANDARD PRESCRIBED VALUES VALORE PRESCRITTO VALORES STANDARD NORMA STANDARDWERTE	PORTLAND collection *
 Length and width. <i>Lunghezza e larghezza.</i> Longitud y anchura. Länge und Breite		ISO 10545-2	± 0,6% max.	± 0,1%
 Thickness. <i>Spessore.</i> Grosor. Stärke		ISO 10545-2	± 5% max.	± 2%
 90° Orthogonality. <i>Ortogonalità.</i> Ortogonalidad. Rechtwinkligkeit		ISO 10545-2	± 0,6% max.	± 0,2%
 Straightness of sides. <i>Rettilinearità dei lati.</i> Rectitud de lados. Kantengeradigkeit		ISO 10545-2	± 0,5% max.	± 0,2%
 Surfaces flatness. <i>Planarità.</i> Planitud. Ebenflächigkeit		ISO 10545-2	± 0,5% max.	± 0,2%
PHYSICAL PROPERTIES / PROPIETÀ FISICHE / PROPIEDADES FÍSICAS / PHYSIKALISCHE EIGENSCHAFTEN				
 Water absorption. <i>Assorbimento d' acqua.</i> Absorción de agua. Wasseraufnahme		ISO 10545-3	≤ 0,5%	≤ 0,1%
 Breaking strength, in N. <i>Carico di rottura, en N.</i> Carga de rotura, en N. Bruchlast, in N	thickness > 7,5 mm spessore > 7,5 mm grosor > 7,5 mm	ISO 10545-4	≥ 1300 N	2400 N *
 Modulus of rupture. <i>Resistenza alla flessione.</i> Resistencia a la flexión. Biegefestigkeit		ISO 10545-4	≥ 35 N/mm <sup>2</sup>	56 N/mm <sup>2</sup> *
 Resistance to deep abrasion. <i>Resistenza all' abrasione profonda.</i> Resistencia a la abrasión profunda. Tiefverschleissbeständigkeit		ISO 10545-6	≤ 175 mm <sup>3</sup>	115 mm <sup>3</sup> *
 Resistance to thermal shock. <i>Resistenza agli sbalzi termici.</i> Resistencia al choque térmico. Temperaturwechselbeständigkeit		ISO 10545-9	No surface defects should be visible Non deve presentare difetti visibili No debe presentar defectos superficiales visibles	Resistant. Resistente. Resistente
 Frost resistance. <i>Resistenza al gelo.</i> Resistencia a la helada. Frostbeständigkeit		ISO 10545-12	No surface defects or cracks should be visible Non deve presentare difetti visibili No debe presentar defectos ni grietas superficiales visibles	Frost Resistant Antighiaccio Resistente a la Helada
 Coefficient of friction. <i>Resistenza allo scivolamento.</i> Coeficiente de fricción. Rutschfestigkeit		DIN 51130 UNE - ENV 12633	WET TEST/ENSAYO EN HÚMEDO DRY TEST/ENSAYO EN SECO	<b>R10</b> ** Clase 1 *** - Clase 2 **** - Clase 3 ***** DCOF - ANSI A 137.1-2012 > 0.42
 Colour resistance to light. <i>Resistenza dei colori alla luce.</i> Resistencia del color a la luz. Lichtbeständigkeit der Farben		DIN 51094	There should be no colour variations Non deve presentare difetti visibili No debe presentar variaciones de color	No alterations to colour and shine Non presenta alterazioni di colori e lucentezza No presenta variaciones de color y brillo
CHEMICAL PROPERTIES / PROPIETÀ CHIMICHE / PROPIEDADES QUÍMICAS / CHEMISCHEN EIGENSCHAFTEN				
 Chemical resistance. <i>Resistenza agli agenti chimici.</i> Resistencia química. Chemikalienbeständigkeit		ISO 10545-13	Resistance to household cleaning products and swimming pools salts. Resistencia a productos domésticos y sales para piscinas	Min. UB
 Resistance to staining. <i>Resistenza alle macchie.</i> Resistencia a las manchas. Fleckenbeständigkeit		ISO 10545-14	≥ 3	5

\*The Land values are the average of different production consignments. For further detail information, please check with our commercial network. / I valori dichiarati sono ottenuti da una media di prove effettuate su diverse produzioni. Per avere informazioni dettagliate consultare la rete commerciale / Los valores declarados son el promedio obtenido a través de ensayos de diferentes producciones. Para la obtención de una información detallada consultar a la red comercial.

\*\* R10 - Test done in PORTLAND GREY LAPPATO 30x60 on September 2011. (batch 07-09-2011)

\*\*\* Clase 1 - Tested in natural finish (It depends on the consignment) Test realized in internal laboratory / Provare realizzato in laboratorio interno / Ensayo realizado en laboratorio interno.

\*\*\*\* Clase 2 - Tested in lappato finish (It depends on the consignment) Test realized in internal laboratory / Provare realizzato in laboratorio interno / Ensayo realizado en laboratorio interno.

\*\*\*\*\* Dry Test, according to document DA DB-SUA/3 (Código Técnico de la Edificación) M° de Fomento. Test done in PORTLAND GREY NATURAL 30x60 on May 2012.

Ensayo realizado, según documento DA DB-SUA/3 (Código Técnico de la edificación) M° de Fomento, sobre el producto PORTLAND GREY NATURAL 30x60 a fecha Mayo 2012.

# 3Dimensional

SPECIAL PIECES. PEZZI SPECIALI. PIEZAS ESPECIALES

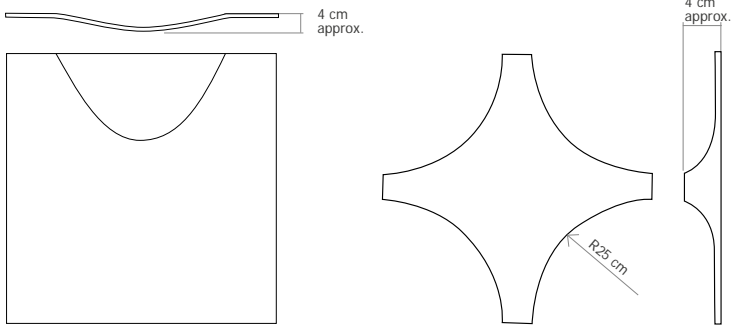

## BAG\*

89,46 X 89,46 cm / 59,55x59,55 cm

- Portland Bag 89,46x89,46 cm **G-5795**
- Portland Bag 59,55x59,55 cm **G-5449**

## STAR\*

59,55x58,88 cm

- Portland Star 59,55x58,88 cm **G-5499**

\* Available in all colours from Portland collection.  
Disponible en todos los colores de la colección Portland.

This is a natural product made through a handmade process, therefore, its possible shade or size variations must be considered as typical features of the material and they will not be admitted in a claim.

Este es un producto natural fabricado artesanalmente, por lo que posibles variaciones de tono o dimension deben considerarse propias del material y no será objeto de reclamación.

+ INFO pag. 208



PORTLAND

Portland Grey Natural Bag 89,46x89,46 cm

# PORTLAND SLIM



CONCRETE



\* Portland slim ivory natural. Content of recycled material.

## FORMATS.FORMATI.FORMATOS



30X90 natural  
29,75x89,46 cm - 11.71"x35.22"

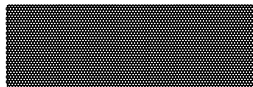

30X90 hexagon  
29,75x89,46 cm - 11.71"x35.22"

## SPECIAL PIECES.PEZZI SPECIALI.PIEZAS ESPECIALES



30X30 mosaico 2,5x2,5  
29,75x29,75 cm - 11.71"x11.71"

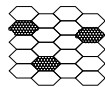

30X30 mosaico hexagonal 6x7,5  
29,75x29,75 cm - 11.71"x11.71"

## THICKNESS.SPESSORE.ESPESORES

 0,48 cm approx. / 0.19" approx.

## COLOURS COLORI COLORES

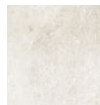

Ivory

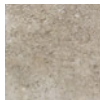

Vison

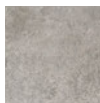

Grey

## FINISHES FINITURI ACABADOS



Natural

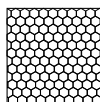

Hexagon

PORTLAND SLIM

# PORTLAND SLIM ivory

## PLAIN TILES.BASE.BASES



**Portland slim ivory natural**  
29,75 x 89,46 cm - 11.71" x 35.22"  
G-6224



**Portland slim ivory hexagon**  
29,75 x 89,46 cm - 11.71" x 35.22"  
G-6246

## SPECIAL PIECES.PEZZI SPECIALI.PIEZAS ESPECIALES

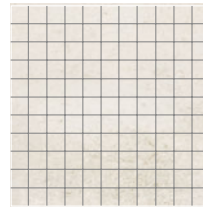

**Portland slim ivory natural  
mosaico 2,5x2,5**  
29,75 x 29,75 cm - 11.71" x 11.71"  
G-6756



**Portland slim ivory  
mosaico hexagonal 6x7,5\***  
29,75 x 29,75 cm - 11.71" x 11.71"  
G-6796

\* The three hexagonal tesserae change pattern randomly.  
Las tres teselas hexagon cambian de posición aleatoriamente.

## COMPLEMENTS.COMPLEMENTI.COMPLEMENTOS

**Fusion graffiato lista 90**  
1,5 x 89,46 cm - 0.59" x 35.22"



G-5091



PORTLAND SLIM

wall: Portland Slim Ivory Hexagon\_Grey Natural 29,75x89,46 cm floor: Portland Ivory Natural 89,46x89,46 cm

# PORTLAND SLIM grey

## PLAIN TILES.BASE.BASES

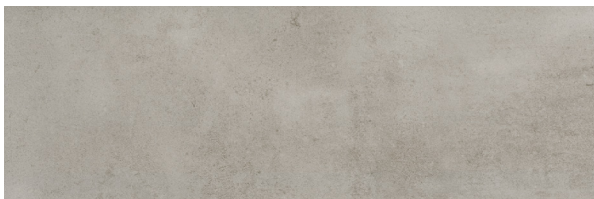

**Portland slim grey natural**  
29,75 x 89,46 cm - 11.71" x 35.22"  
G-6224

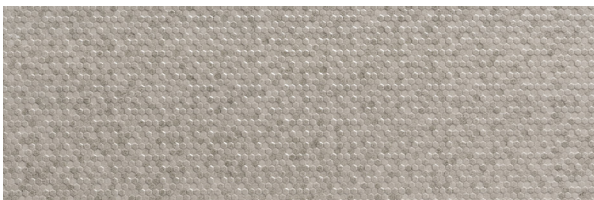

**Portland slim grey hexagon**  
29,75 x 89,46 cm - 11.71" x 35.22"  
G-6246

## SPECIAL PIECES.PEZZI SPECIALI.PIEZAS ESPECIALES

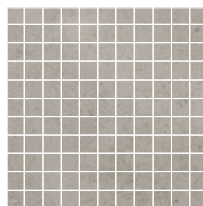

**Portland slim grey natural  
mosaico 2,5x2,5**  
29,75 x 29,75 cm - 11.71" x 11.71"  
G-6756



**Portland slim grey  
mosaico hexagonal 6x7,5\***  
29,75 x 29,75 cm - 11.71" x 11.71"  
G-6796

\* The three hexagonal tesserae change pattern randomly.  
Las tres teselas hexagon cambian de posición aleatoriamente.

## COMPLEMENTS.COMPLEMENTI.COMPLEMENTOS

**Fusion graffiato lista 90**  
1,5 x 89,46 cm - 0.59" x 35.22"



G-5091



PORTLAND SLIM

wall: Portland Slim Grey Hexagon\_Grey Natural 29,75x89,46 cm floor: Portland Grey Lappato Hexagonal

# PORTLAND SLIM **vison**

## PLAIN TILES.BASE.BASES



### Portland slim vison natural

29,75 x 89,46 cm - 11.71" x 35.22"

G-6224



### Portland slim vison hexagon

29,75 x 89,46 cm - 11.71" x 35.22"

G-6246

## SPECIAL PIECES.PEZZI SPECIALI.PIEZAS ESPECIALES

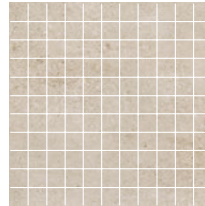

### Portland slim vison natural mosaico 2,5x2,5

29,75 x 29,75 cm - 11.71" x 11.71"

G-6756

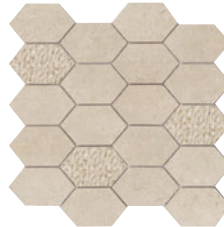

### Portland slim vison mosaico hexagonal 6x7,5\*

29,75 x 29,75 cm - 11.71" x 11.71"

G-6796

\* The three hexagonal tesserae change pattern randomly.  
Las tres teselas hexagon cambian de posición aleatoriamente.

## COMPLEMENTS.COMPLEMENTI.COMPLEMENTOS

### Fusion graffiato lista 90

1,5 x 89,46 cm - 0.59" x 35.22"















G-5091



PORTLAND SLIM

wall: Portland Slim Vison Hexagon\_ Ivory Hexagon\_ Vison Natural 29,75x89,46 cm floor: Portland Visón Natural 89,46x89,46 cm

# TECHNICAL CHARACTERISTICS.CARATTERISTICHE TECNICHE.CARACTERÍSTICAS TÉCNICAS

MEASUREMENTS AND SURFACES APPEARANCE / DIMENSIONI E ASPETTO SUPERFICIALE / MEDIDAS Y ASPECTO SUPERFICIAL / MASEN UND AUSSEHEN DER OBERFLÄCHE		STANDARD TEST METHOD METODO DELLA NORMA METODO DE ENSAYO STANDARD TEST METHOD	STANDARD PRESCRIBED VALUES VALORE PRESCRITTO VALORES STANDARD NORMA STANDARDWERTE	<b>Portland Slim</b> *
 <b>Length and width.</b> <i>Lunghezza e larghezza.</i> Longitud y anchura. Länge und Breite		ISO 10545-2	± 0,6% max.	± 0,1% *
 <b>Orthogonality.</b> <i>Ortogonalità.</i> Ortogonalidad. Rechtwinkligkeit		ISO 10545-2	± 0,6% max.	± 0,2% *
 <b>Straightness of sides.</b> <i>Rettilinearità dei lati.</i> Rectitud de lados. Kantengeradigkeit		ISO 10545-2	± 0,5% max.	± 0,2% *
 <b>Surfaces flatness.</b> <i>Planarità.</i> Planitud. Ebenfächigkeit		ISO 10545-2	± 0,5% max.	± 0,2% *
PHYSICAL PROPERTIES / PROPIETÀ FISICHE / PROPIEADADES FÍSICAS / PHYSIKALISCHE EIGENSCHAFTEN				
 <b>Water absorption.</b> <i>Assorbimento d'acqua.</i> Absorción de agua. Wasseraufnahme		ISO 10545-3	≤ 0,5%	0,1%
 <b>Breaking strength, in N.</b> <i>Carico di rottura, en N.</i> Carga de rotura, en N. Bruchlast, in N	thickness <75 mm spessore <7,5 mm grosor <7,5 mm	ISO 10545-4	≥ 700 N	Available Method * Metodo Disponibile Método Disponible
 <b>Modulus of rupture</b> <i>Resistenza alla flessione.</i> Resistencia a la flexión. Biegefestigkeit		ISO 10545-4	≥ 35 N/mm <sup>2</sup>	>40 N/mm <sup>2</sup> *
 <b>Resistance to thermal shock.</b> <i>Resistenza agli sbalzi termici.</i> Resistencia al choque térmico. Temperaturwechselbeständigkeit		ISO 10545-9	No surface defects should be visible Non deve presentare difetti visibili No debe presentar defectos superficiales visibles	Resistant. Resistente. Resistente
 <b>Frost resistance.</b> <i>Resistenza al gelo.</i> Resistencia a la helada. Frostbeständigkeit		ISO 10545-12	No surface defects or cracks should be visible Non deve presentare difetti visibili No debe presentar defectos ni grietas superficiales visibles	Frost Resistant Antighaccio Resistente a la Helada
 <b>Coefficient of friction.</b> <i>Resistenza allo scivolamento.</i> Coeficiente de fricción. Rutschfestigkeit		DIN 51130		Available Method Metodo Disponibile Método Disponible
 <b>Colour resistance to light.</b> <i>Resistenza dei colori alla luce.</i> Resistencia del color a la luz. Lichtbeständigkeit der Farben		DIN 51094	There should be no colour variations Non deve presentare difetti visibili No debe presentar variaciones de color	No alterations in colour and shine Non presenta alterazioni di colori e lucentezza No presenta variaciones de color y brillo
CHEMICAL PROPERTIES / PROPIETÀ CHIMICHE / PROPIEADADES QUÍMICAS / CHEMISCHEN EIGENSCHAFTEN				
 <b>Chemical resistance.</b> <i>Resistenza agli agenti chimici.</i> Resistencia química. Chemikalienbeständigkeit		ISO 10545-13	Resistance to household cleaning products and swimmingpools salts. Resistenza a prodotti domestici e sales para piscinas	Min. GB
 <b>Resistance to staining.</b> <i>Resistenza alle macchie.</i> Resistencia a las manchas. Fleckenbeständigkeit		ISO 10545-14	≥ 3	5 *

\*The Land values are the average of different production consignments. For further detail information, please check with our commercial network. /  
I valori dichiarati sono ottenuti da una media di prove effettuate su diverse produzioni. Per avere informazioni dettagliate consultare la rete commerciale /  
Los valores declarados son el promedio obtenido a través de ensayos de diferentes producciones. Para la obtención de una información detallada consultar a la red comercial.

## ADVANTAGES.VANTAGGI.VENTAJAS

- Time. *Tempo.* Tiempo
- Money. *Denaro.* Dinero
- Hygiene. *Igiene.* Higiene
- Ecologic. *Ecologia.* Ecología
- Technology. *Tecnologia.* Tecnología

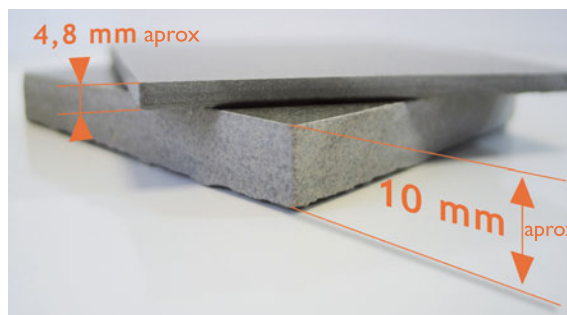

\* Recommended only for wall. /  
sólo recomendado como revestimiento.



PORTLAND SLIM

wall: Portland Slim Grey Hexagon 29,75x89,46 cm

# CIVIC



CONCRETE



SHOWROOM RIMADESIO  
Madrid. (SPAIN)  
Arch. INZENSO Estudio



PRIVATE HOUSE  
Messelbroek. (BELGIUM)

\* Civic grey natural. Content of recycled material. Contenido de material reciclado.

## FORMATS.FORMATI.FORMATOS

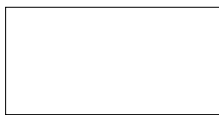

**45X90**  
44,63x89,46 cm - 17.57"x35.22"

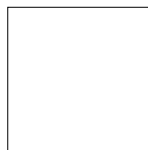

**60X60**  
59,55x59,55 cm  
23.45"x23.45"



**22,5X90**  
22,21x89,46 cm - 8.75"x35.22"



**30X60**  
29,75x59,55 cm - 11.71"x23.45"



**7,5X90**  
7,3x89,46 cm - 2.87"x35.22"



**7,5X60**  
7,3x59,55 cm - 2.87"x23.45"

## SPECIAL PIECES.PEZZI SPECIALI.PIEZAS ESPECIALES



**30X60 preincisión 2,5x60**  
29,75x59,55 cm - 11.71"x23.45"



**30X30 multicolor**  
29,75x29,75 cm - 11.71"x11.71"



**30X30 mosaico ice / steel 2,5x2,5**  
29,75x29,75 cm - 11.71"x11.71"



**30X30 mosaico 2,5x2,5**  
29,75x29,75 cm - 11.71"x11.71"



**7,5X60 rodapié**  
7,2x59,55 cm - 2.83"x23.45"



**7,5X45 rodapié**  
7,2x44,63 cm - 2.83"x17.57"

## THICKNESS.SPESSORE.ESPESORES

- ≡ 1,11 cm / 0.44" approx.
- ≡ 1,03 cm / 0.40" approx.

45x90 cm / 22,5x90 cm FORMATS  
30x60 cm / 60x60 cm FORMATS

## COLOURS COLORI COLORES

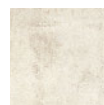

**Ivory**



**Grey**

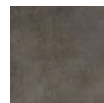

**Antracita**

## FINISHES FINITURI ACABADOS



**Natural**

# CIVIC ivory

PLAIN TILES.BASE.BASES



**Civic ivory natural**  
44,63 x 89,46 cm - 17.57" x 35.22"  
G-6410

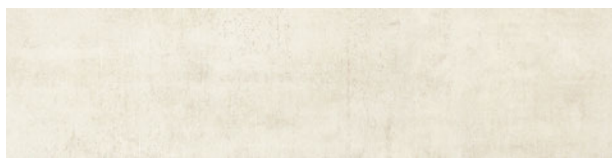

**Civic ivory natural**  
22,21 x 89,46 cm - 8.75" x 35.22"  
G-6456



**Civic ivory natural**  
59,55 x 59,55 cm - 23.45" x 23.45"  
G-6410

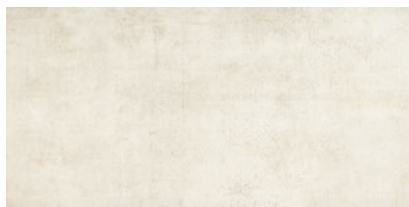

**Civic ivory natural**  
29,75 x 59,55 cm - 11.71" x 23.45"  
G-6298

## SPECIAL PIECES.PEZZI SPECIALI.PIEZAS ESPECIALES



**Civic ivory natural preincisión 2,5x60**  
29,75 x 59,55 cm - 11.71" x 23.45"  
G-6486



**Civic ivory natural mosaico 2,5x2,5**  
29,75 x 29,75 cm - 11.71" x 11.71"  
G-6756

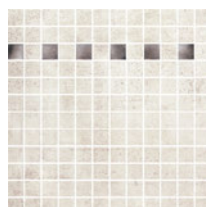

**Civic ivory natural mosaico steel 2,5x2,5**  
29,75 x 29,75 cm - 11.71" x 11.71"  
G-6844

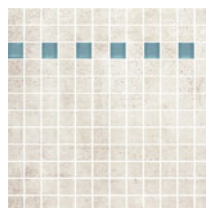

**Civic ivory natural mosaico ice 2,5x2,5**  
29,75 x 29,75 cm - 11.71" x 11.71"  
G-6844



**Civic multicolor natural**  
29,75 x 29,75 cm - 11.71" x 11.71"  
G-5149



**Civic ivory natural listelo 90**  
7,3 x 89,46 cm - 2.87" x 35.22"  
G-5119



**Civic ivory natural listelo 60**  
7,3 x 59,55 cm - 2.87" x 23.45"  
G-5091



**Civic ivory natural rodapié 60**  
7,3 x 59,55 cm - 2.87" x 23.45"  
G-5097



**Civic ivory natural rodapié 45**  
7,3 x 44,63 cm - 2.87" x 17.57"  
G-5087



**Civic ivory natural rodapié 30**  
7,3 x 29,75 cm - 2.87" x 11.71"  
G-5075

## STEPS.GRADINI.PELDAÑOS

**SIMPLE**

pedaño simple-30 (30x60 cm)	5195
pedaño simple-60 (30x60 cm)	5195
pedaño simple-áng. (30x60 cm)	5211
pedaño simple-60 (60x60 cm)	5281
pedaño simple-áng (60x60 cm)	5299
pedaño simple-90 (45x90 cm)	5333
pedaño simple-áng. (45x90 cm)	5345

**GRADONE**

pedaño grad-30 (30x60 cm)	5559
pedaño grad-60 (30x60 cm)	5559
pedaño grad-áng. (30x60 cm)	5609
pedaño grad-60 (60x60 cm)	5585
pedaño grad-áng. (60x60 cm)	5633
pedaño grad-90 (45x90 cm)	5623
pedaño grad-áng. (45x90 cm)	5645

+ INFO pag. 207.

## COMPLEMENTS.COMPLEMENTI.COMPLEMENTOS



**Byte white / ice / yellow / orange / red / purple / blue / grey / moss / black lista 90\***  
2 x 89,46 cm - 0.79" x 35.22"



G-5173

**Fusion graffiato lista 90**  
1,5 x 89,46 cm - 0.59" x 35.22"



G-5091

**Byte ice / yellow / red / black lista 60\***  
1,5 x 59,55 cm - 0.59" x 23.45"



G-5100

**Fusion natural lista 60\***  
1 x 59,55 cm - 0.39" x 23.45"



G-5049

**Fusion graffiato lista 60**  
1,5 x 59,55 cm - 0.59" x 23.45"



G-5069

\* recommended only for walls



**Civic grey natural**  
44,63 x 89,46 cm - 17.57" x 35.22"  
G-6372



**Civic grey natural**  
22,21 x 89,46 cm - 8.75" x 35.22"  
G-6426

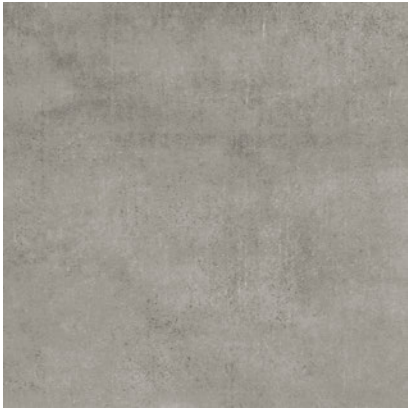

**Civic grey natural**  
59,55 x 59,55 cm - 23.45" x 23.45"  
G-6372

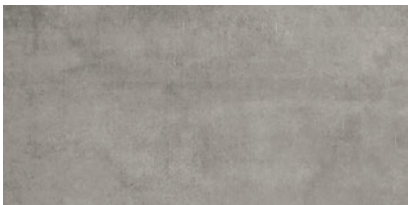

**Civic grey natural**  
29,75 x 59,55 cm - 11.71" x 23.45"  
G-6258

SPECIAL PIECES.PEZZI SPECIALI.PIEZAS ESPECIALES



**Civic grey natural preincisión 2,5x60**  
29,75 x 59,55 cm - 11.71" x 23.45"  
G-6486

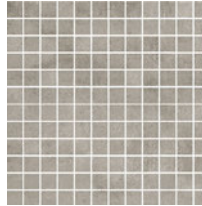

**Civic grey natural mosaico 2,5x2,5**  
29,75 x 29,75 cm - 11.71" x 11.71"  
G-6756

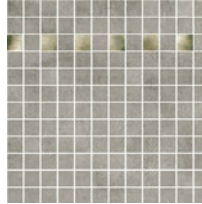

**Civic grey natural mosaico steel 2,5x2,5**  
29,75 x 29,75 cm - 11.71" x 11.71"  
G-6844

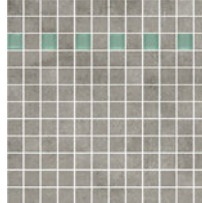

**Civic grey natural mosaico ice 2,5x2,5**  
29,75 x 29,75 cm - 11.71" x 11.71"  
G-6844



**Civic multicolor natural**  
29,75 x 29,75 cm - 11.71" x 11.71"  
G-5149



**Civic grey natural listelo 90**  
7,3 x 89,46 cm - 2.87" x 35.22"  
G-5119



**Civic grey natural listelo 60**  
7,3 x 59,55 cm - 2.87" x 23.45"  
G-5091



**Civic grey natural rodapié 60**  
7,3 x 59,55 cm - 2.87" x 23.45"  
G-5097



**Civic grey natural rodapié 45**  
7,3 x 44,63 cm - 2.87" x 17.57"  
G-5087



**Civic grey natural rodapié 30**  
7,3 x 29,75 cm - 2.87" x 11.71"  
G-5075

STEPS.GRADINI.PELDAÑOS

SIMPLE



pedaño simple-30 (30x60 cm)	5171
pedaño simple-60 (30x60 cm)	5171
pedaño simple áng. (30x60 cm)	5187
pedaño simple-60 (60x60 cm)	5881
pedaño simple áng. (60x60 cm)	5299
pedaño simple-90 (45x90 cm)	5323
pedaño simple áng. (45x90 cm)	5333

GRADONE



pedaño grad-30 (30x60 cm)	5559
pedaño grad-60 (30x60 cm)	5559
pedaño grad áng. (30x60 cm)	5609
pedaño grad-60 (60x60 cm)	5585
pedaño grad áng. (60x60 cm)	5633
pedaño grad-90 (45x90 cm)	5623
pedaño grad áng. (45x90 cm)	5645

+ INFO pag. 207.

**Civic natural** **CLASE 1**  
UNE - ENV 12633

The material reproduces the look of concrete through its smooth relieves and the uneven color tones of its pieces.  
Il prodotto crea l'effetto del calcestruzzo tramite la stonalizzazione e il leggero rilievo dei singoli pezzi.  
El producto reproduce la apariencia del hormigón con la destonificación y el suave relieve de las piezas.

# CIVIC antracita

PLAIN TILES.BASE.BASES



**Civic antracita natural**  
44,63 x 89,46 cm - 17.57" x 35.22"  
G-6372

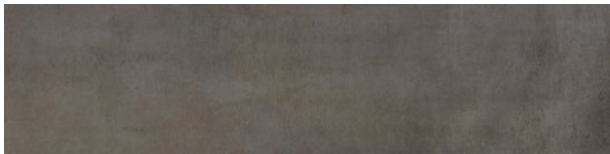

**Civic antracita natural**  
22,21 x 89,46 cm - 8.75" x 35.22"  
G-6426



**Civic antracita natural**  
59,55 x 59,55 cm - 23.45" x 23.45"  
G-6372

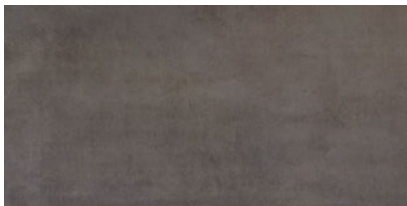

**Civic antracita natural**  
29,75 x 59,55 cm - 11.71" x 23.45"  
G-6258

## SPECIAL PIECES.PEZZI SPECIALI.PIEZAS ESPECIALES



**Civic antracita natural preincisión 2,5x60**  
29,75 x 59,55 cm - 11.71" x 23.45"  
G-6486

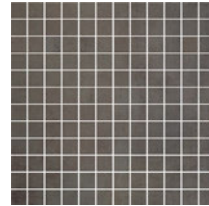

**Civic antracita natural mosaico 2,5x2,5**  
29,75 x 29,75 cm - 11.71" x 11.71"  
G-6756

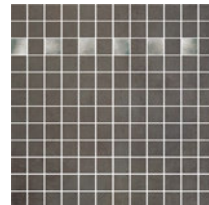

**Civic antracita natural mosaico steel 2,5x2,5**  
29,75 x 29,75 cm - 11.71" x 11.71"  
G-6844

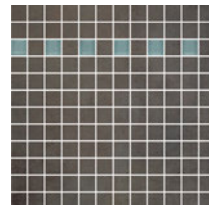

**Civic antracita natural mosaico ice 2,5x2,5**  
29,75 x 29,75 cm - 11.71" x 11.71"  
G-6844



**Civic multicolor natural**  
29,75 x 29,75 cm - 11.71" x 11.71"  
G-5149



**Civic antracita natural listelo 90**  
7,3 x 89,46 cm - 2.87" x 35.22"  
G-5119



**Civic antracita natural listelo 60**  
7,3 x 59,55 cm - 2.87" x 23.45"  
G-5091



**Civic antracita natural rodapié 60**  
7,3 x 59,55 cm - 2.87" x 23.45"  
G-5097



**Civic antracita natural rodapié 45**  
7,3 x 44,63 cm - 2.87" x 17.57"  
G-5087



**Civic antracita natural rodapié 30**  
7,3 x 29,75 cm - 2.87" x 11.71"  
G-5075

## STEPS.GRADINI.PELDAÑOS

SIMPLE	GRADONE
peldaño simple-30 (30x60 cm) 5171	peldaño grad-30 (30x60 cm) 5559
peldaño simple-60 (30x60 cm) 5171	peldaño grad-60 (30x60 cm) 5559
peldaño simple áng. (30x60 cm) 5187	peldaño grad áng. (30x60 cm) 5609
peldaño simple-60 (60x60 cm) 5281	peldaño grad-60 (60x60 cm) 5585
peldaño simple ang (60x60 cm) 5299	peldaño grad áng. (60x60 cm) 5633
peldaño simple-90 (45x90 cm) 5323	peldaño grad-90 (45x90 cm) 5707
peldaño simple áng. (45x90 cm) 5645	peldaño grad áng. (45x90 cm) 5723

+ INFO pag. 207.

## COMPLEMENTS.COMPLEMENTI.COMPLEMENTOS



**Byte white / ice / yellow / orange / red / purple / blue / grey / moss / black lista 90\***  
2 x 89,46 cm - 0.79" x 35.22"  
G-5173

**Fusion graffiato lista 90**  
1,5 x 89,46 cm - 0.59" x 35.22"  
G-5091

**Byte ice / yellow / red / black lista 60\***  
1,5 x 59,55 cm - 0.59" x 23.45"  
G-5100

**Fusion natural lista 60\***  
1 x 59,55 cm - 0.39" x 23.45"  
G-5049

**Fusion graffiato lista 60**  
1,5 x 59,55 cm - 0.59" x 23.45"  
G-5069

\* recommended only for walls

















Civic Grey Natural\_Antracita Natural\_Ivory Natural 29,75x59,55 cm

AIRPORT FACILITIES  
Palma de Mallorca. (SPAIN)

CIVIC



# TECHNICAL CHARACTERISTICS. CARATTERISTICHE TECNICHE. CARACTERÍSTICAS TÉCNICAS

MEASUREMENTS AND SURFACES APPEARANCE / DIMENSIONI E ASPETTO SUPERFICIALE / MEDIDAS Y ASPECTO SUPERFICIAL / MASSEN UND AUSSEHEN DER OBERFLÄCHE		STANDARD TEST METHOD METODO DELLA NORMA METODO DE ENSAYO STANDARD TEST METHOD	STANDARD PRESCRIBED VALUES VALORE PRESCRITTO VALORES STANDARD NORMA STANDARDWERTE	CIVIC collection *
 <b>Length and width.</b> <i>Lunghezza e larghezza.</i> Longitud y anchura. Länge und Breite		ISO 10545-2	± 0,6% max.	± 0,1%
 <b>Thickness.</b> <i>Spessore.</i> Grosor. Stärke		ISO 10545-2	± 5% max.	± 2%
 <b>90° Orthogonality.</b> <i>Ortogonalità.</i> Ortogonalidad. Rechtwinkligkeit		ISO 10545-2	± 0,6% max.	± 0,2%
 <b>Straightness of sides.</b> <i>Rettilinearità dei lati.</i> Rectitud de lados. Kantengeradigkeit		ISO 10545-2	± 0,5% max.	± 0,2%
 <b>Surfaces flatness.</b> <i>Planarità.</i> Planitud. Ebenföchigkeit		ISO 10545-2	± 0,5% max.	± 0,2%
PHYSICAL PROPERTIES / PROPIETÀ FISICHE / PROPIEDADES FÍSICAS / PHYSIKALISCHE EIGENSCHAFTEN				
 <b>Water absorption.</b> <i>Assorbimento d' acqua.</i> Absorción de agua. Wasseraufnahme		ISO 10545-3	≤ 0,5%	≤ 0,1%
 <b>Breaking strength, in N.</b> <i>Carico di rottura, en N.</i> Carga de rotura, en N. Bruchlast, in N	thickness > 7,5 mm spessore > 7,5 mm grosor > 7,5 mm	ISO 10545-4	≥ 1300 N	2400 N*
 <b>Modulus of rupture.</b> <i>Resistenza alla flessione.</i> Resistencia a la flexión. Biegefestigkeit		ISO 10545-4	≥ 35 N/mm <sup>2</sup>	60 N/mm <sup>2</sup> **
 <b>Resistance to deep abrasion.</b> <i>Resistenza all' abrasione profonda.</i> Resistencia a la abrasión profunda. Tiefverschleissbeständigkeit		ISO 10545-6	≤ 175 mm <sup>3</sup>	128 mm <sup>3</sup> **
 <b>Resistance to thermal shock.</b> <i>Resistenza agli sbalzi termici.</i> Resistencia al choque térmico. Temperaturwechselbeständigkeit		ISO 10545-9	No surface defects should be visible <i>Non deve presentare difetti visibili</i> No debe presentar defectos superficiales visibles	Resistant. Resistente. Resistente
 <b>Frost resistance.</b> <i>Resistenza al gelo.</i> Resistencia a la helada. Frostbeständigkeit		ISO 10545-12	No surface defects or cracks should be visible <i>Non deve presentare difetti visibili</i> No debe presentar defectos ni grietas superficiales visibles	Frost Resistant <i>Antighaccio</i> Resistente a la Helada
 <b>Coefficient of friction.</b> <i>Resistenza allo scivolamento.</i> Coeficiente de fricción. Rutschfestigkeit		UNE - ENV 12633	WET TEST/ENSAYO EN HÚMEDO DRY TEST/ENSAYO EN SECO	Clase 1*** Clase 3****
 <b>Colour resistance to light.</b> <i>Resistenza dei colori alla luce.</i> Resistencia del color a la luz. Lichtbeständigkeit der Farben		DIN 51094	There should be no colour variations <i>Non deve presentare difetti visibili</i> No debe presentar variaciones de color	No alterations to colour and shine <i>Non presenta alterazioni di colori e lucentezza</i> No presenta variaciones de color y brillo
CHEMICAL PROPERTIES / PROPIETÀ CHIMICHE / PROPIEDADES QUÍMICAS / CHEMISCHEN EIGENSCHAFTEN				
 <b>Chemical resistance.</b> <i>Resistenza agli agenti chimici.</i> Resistencia química. Chemikalienbeständigkeit		ISO 10545-13	Resistance to household cleaning products and swimmingpools salts. <i>Resistencia a productos domésticos y sales para piscinas</i>	Min. UB
 <b>Resistance to staining.</b> <i>Resistenza alle macchie.</i> Resistencia a las manchas. Fleckenbeständigkeit		ISO 10545-14	≥ 3	5

\*The Land values are the average of different production consignments. For further detail information, please check with our commercial network. / I valori dichiarati sono ottenuti da una media di prove effettuate su diverse produzioni. Per avere informazioni dettagliate consultare la rete commerciale / Los valores declarados son el promedio obtenido a través de ensayos de diferentes producciones. Para la obtención de una información detallada consultar a la red comercial.

\*\* Test realized in Civic Grey 45x90. Provare realizzato in Civic Grey 45x90. Ensayo realizado en Civic Grey 45x90.

\*\*\* Test realized in internal laboratory. Provare realizzato in laboratorio interno. Ensayo realizado en laboratorio interno.

\*\*\*\* Dry Test, according to document DA DB-SUA/3 (Código Técnico de la Edificación) M° de Fomento. Average test result value, on May 2012. Ensayo realizado, según documento DA DB-SUA/3 (Código Técnico de la edificación) M° de Fomento, valor medio a fecha Mayo 2012.



Civic Grey Natural 59,55x59,55 cm

ALLENDE ARCHITECTS OFFICE  
Madrid, (SPAIN)  
Arch. MANUEL MALLO - LUIS DE PEREDA

CIVIC

# KANKARE



STONE



\* Kankare ivory natural. Content of recycled material.

## FORMATS.FORMATI.FORMATOS

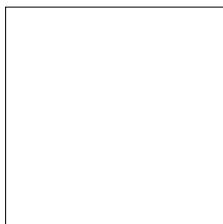

**90X90**  
89,46x89,46 cm - 35.22"x35.22"

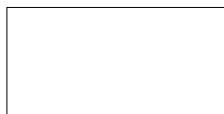

**45X90**  
44,63x89,46 cm - 17.61"x35.22"



**7,5X90**  
7,3x89,46 cm - 2.87"x35.22"



**7,5X45**  
7,3x44,63 cm - 2.87"x17.61"

## SPECIAL PIECES.PEZZI SPECIALI.PIEZAS ESPECIALES

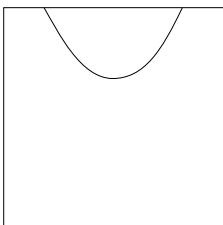

**90X90 Bag\***  
89,46x89,46 cm - 35.22"x35.22"  
**45X90 Bag\***  
44,63 x 89,46 cm - 17.57" x 35.22"  
+ INFO pag. 210



**7,5X90 rodapié**  
7,3x89,46 cm - 2.87"x35.22"

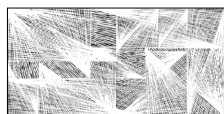

**45X90 Lines**  
44,63x89,46 cm - 17.61"x35.22"



**45X90 Rubic**  
44,63x89,46 cm - 17.61"x35.22"



**7,5X45 rodapié**  
7,3x44,63 cm - 2.87" x 17.61"



**30X30 mosaico 3,5x3,5**  
29,75x29,75 cm - 11.71"x11.71"



**15X90 Chevron**  
14,77x89,46 cm - 17.61"x35.22"

## THICKNESS.SPESSORE.ESPEORES

≡ 0,74 cm / 0,27" approx.

## COLOURS COLORI COLORES

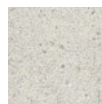

**Ivory**

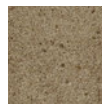

**Vison**

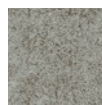

**Grey**

## FINISHES FINITURI ACABADOS

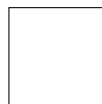

**Natural**



**Non-slip**

## PLAIN TILES. BASE. BASES



**Kankare ivory natural**  
89,46 x 89,46 cm - 35.22" x 35.22"  
**G-6372**

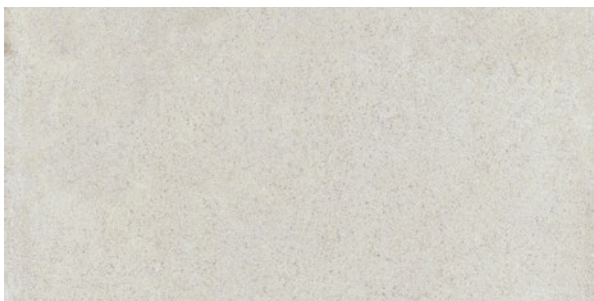

**Kankare ivory natural / Kankare ivory natural non-slip**  
44,63 x 89,46 cm - 17.57" x 35.22"  
**G-6224 / G-6246**

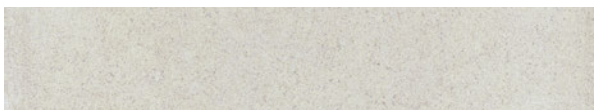

**Kankare ivory cenefa 3 natural**  
14,70 x 89,46cm - 5.90" x 35.22"  
**G-6330**

## SPECIAL PIECES. PEZZI SPECIALI. PIEZAS ESPECIALES



**Kankare ivory lines natural**  
44,63 x 89,46 cm - 17.57" x 35.22"  
**G-6250**

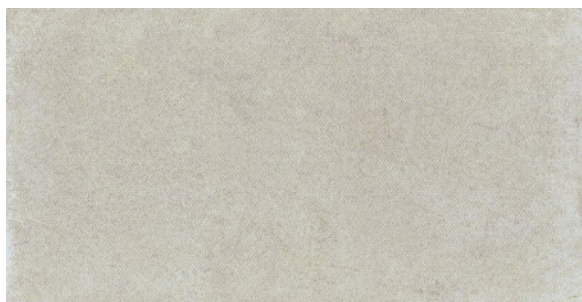

**Kankare ivory rubic natural**  
44,63 x 89,46 cm - 17.57" x 35.22"  
**G-6250**



**Kankare ivory natural rodapié 90**  
7,3 x 89,46 cm - 2.87" x 35.22"  
**G-5125**



**Kankare ivory natural rodapié 45**  
7,3 x 44,63 cm - 2.87" x 17.57"  
**G-5085**

**natural** **CLASE 1** **R9**  
UNE - ENV 12633 DIN 51130

**DCOF>0.42**  
ANSI A 137.1 - 2012

**non-slip** **CLASE 3** **R10**  
UNE - ENV 12633 DIN 51130

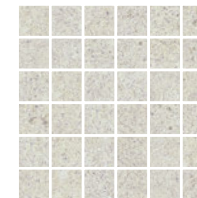

**Kankare ivory natural mosaico 3,5x3,5**  
29,75 x 29,75 cm - 11.71" x 11.71"  
**G-6644**

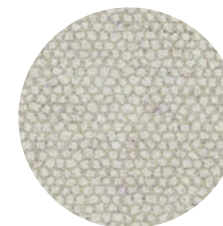

\* DETAIL. Kankare ivory rubic natural  
\* DETALLE. Kankare ivory rubic natural

## STEPS. GRADINI. PELDAÑOS

		natural
SIMPLE		peldaño simple-45 (45x90 cm) 5305
		peldaño simple-90 (90x90 cm) 5585
		peldaño simple áng. (45x90 cm) 5315
GRADONE		peldaño simple áng. (90x90 cm) 5609
		peldaño grad-45 (45x90 cm) 5603
		peldaño grad-90 (90x90 cm) 5779
		peldaño grad. áng. (45x90 cm) 5623
		peldaño grad. áng. (90x90 cm) 5829

+ INFO pag. 207.



Kankare Ivory Natural 89,46x89,46 cm

## PLAIN TILES. BASE. BASES



**Kankare vison natural**

89,46 x 89,46 cm - 35.22" x 35.22"

G-6372

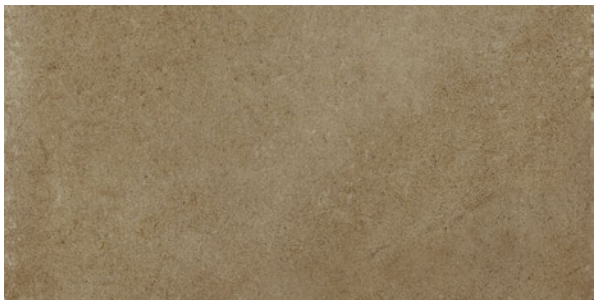

**Kankare vison natural**

44,63 x 89,46 cm - 17.57" x 35.22"

G-6224

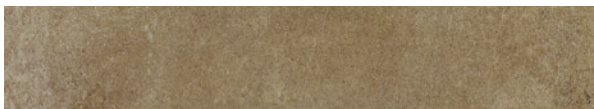

**Kankare vison cenefa 3 natural**

14,70 x 89,46 cm - 5.90" x 35.22"

G-6330

## SPECIAL PIECES. PEZZI SPECIALI. PIEZAS ESPECIALES



**Kankare vison lines natural**

44,63 x 89,46 cm - 17.57" x 35.22"

G-6250



**Kankare vison rubic natural**

44,63 x 89,46 cm - 17.57" x 35.22"

G-6250



**Kankare vison natural rodapié 90**

7,3 x 89,46 cm - 2.87" x 35.22"

G-5125



**Kankare vison natural rodapié 45**

7,3 x 44,63 cm - 2.87" x 17.57"

G-5085

natural

**CLASE 1**

UNE - ENV 12633

**R9**

DIN 51130

**DCOF>0.42**

ANSI A 137.1 - 2012

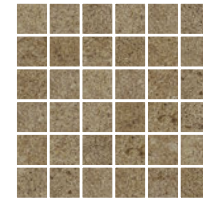

**Kankare vison natural mosaico 3,5x3,5**

29,75 x 29,75 cm - 11.71" x 11.71"

G-6644

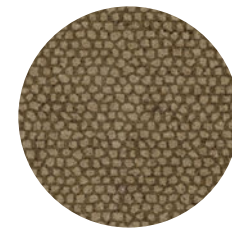

\* DETAIL. Kankare vison rubic natural  
\* DETALLE. Kankare vison rubic natural

## STEPS. GRADINI. PELDAÑOS

SIMPLE 

GRADONE 

		natural
peldaño simple-45	(45x90 cm)	5305
peldaño simple-90	(90x90 cm)	5585
peldaño simple áng.	(45x90 cm)	5315
peldaño simple áng.	(90x90 cm)	5609
peldaño grad-45	(45x90 cm)	5603
peldaño grad-90	(90x90 cm)	5779
peldaño grad. áng.	(45x90 cm)	5623
peldaño grad. áng.	(90x90 cm)	5829

+ INFO pag. 207.



KANKARE

Kankare Vison Natural 89,46x89,46 cm

# KANKARE grey

## PLAIN TILES. BASE. BASES



**Kankare grey natural**  
89,46 x 89,46 cm - 35.22" x 35.22"  
G-6372



**Kankare grey natural**  
44,63 x 89,46 cm - 17.57" x 35.22"  
G-6224

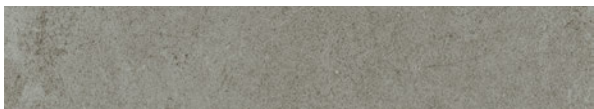

**Kankare grey cenefa 3 natural**  
14,70 x 89,46cm - 5.90" x 35.22"  
G-6330

## SPECIAL PIECES. PEZZI SPECIALI. PIEZAS ESPECIALES



**Kankare grey lines natural**  
44,63 x 89,46 cm - 17.57" x 35.22"  
G-6250



**Kankare grey rubic natural**  
44,63 x 89,46 cm - 17.57" x 35.22"  
G-6250



**Kankare grey natural rodapié 90**  
7,3 x 89,46 cm - 2.87" x 35.22"  
G-5125



**Kankare grey natural rodapié 45**  
7,3 x 44,63 cm - 2.87" x 17.57"  
G-5085

natural **CLASE 1** **R9**  
UNE - ENV 12633 DIN 51130  
**DCOF>0.42**  
ANSI A 137.1 - 2012

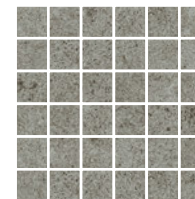

**Kankare grey natural mosaico 3,5x3,5**  
29,75 x 29,75 cm - 11.71" x 11.71"  
G-6644

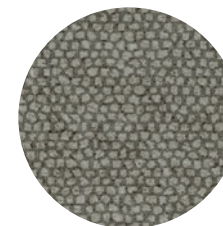

\* DETAIL. Kankare grey rubic natural  
\* DETALLE. Kankare grey rubic natural

## STEPS. GRADINI. PELDAÑOS

		natural
SIMPLE		peldaño simple-45 (45x90 cm) 5305
		peldaño simple-90 (90x90 cm) 5585
		peldaño simple áng. (45x90 cm) 5315
		peldaño simple áng. (90x90 cm) 5609
GRADONE		peldaño grad-45 (45x90 cm) 5603
		peldaño grad-90 (90x90 cm) 5779
		peldaño grad. áng. (45x90 cm) 5623
		peldaño grad. áng. (90x90 cm) 5829

+ INFO pag. 207.



KANKARE

wall: Kankare Ivory Lines 89,46x89,46 cm  
floor: Kankare Grey Natural 89,46x89,46 cm

# KANKARE

SPECIAL PIECES.  
PEZZI SPECIALI. PIEZAS ESPECIALES

natural **CLASE 1** **R9**  
UNE - ENV 12633 DIN 51130  
**DCOF>0.42**  
ANSI A 137.1 - 2012



**Conjunto Kankare ivory & vison natural mosaico 3D\***

44,63x44,63 cm - 17.57" x 17.57"

G-6756\*\*



**Kankare ivory & vison natural hexagon 3D**

18,29x31,56 cm - 7.20" x 12.42"

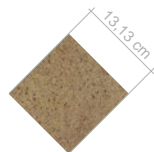

**Taco Kankare vison natural mosaico 3D**

13,13x13,13 cm - 5.17" x 5.17"



**Conjunto Kankare ivory & grey natural mosaico 3D\***

44,63x44,63 cm - 17.57" x 17.57"

G-6756\*\*



**Kankare ivory & grey natural hexagon 3D**

18,29x31,56 cm - 7.20" x 12.42"



**Taco Kankare grey natural mosaico 3D**

13,13x13,13 cm - 5.17" x 5.17"



**Kankare vison chevron natural**

14,70 x 89,46cm - 5.90" x 35.22"

G-6594



**Kankare ivory chevron natural**

14,70 x 89,46cm - 5.90" x 35.22"

G-6594



**Kankare grey chevron natural**

14,70 x 89,46cm - 5.90" x 35.22"

G-6594

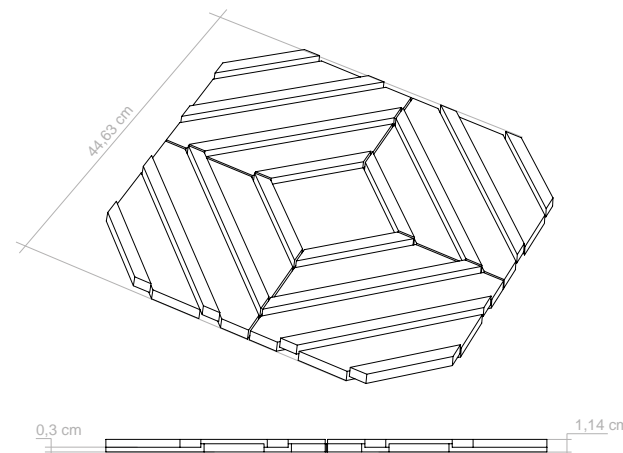

**\*5 PIECE COMPOSITION.**

4xKankare hexagon 3D + 1xKankare taco. An additional taco for composition (included in the box) is required to complete the tile composition on the wall.

**\*COMPOSICIÓN DE 5 PIEZAS.**

4xKankare Hexagon Mos. 3D + 1xKankare Taco Mos. 3D. Un taco adicional por composición (incluido en la caja) es necesario para completar la composición del mosaico en pared.

**\*\*BOX CONTENT:** 4 sets, including: 16xKankare Hexagon Mos. 3D + 8xKankare Taco Mos. 3D.

**\*\*CONTENIDO DE LA CAJA:** 16xKankare Hexagon Mos. 3D + 8xKankare Taco Mos. 3D.

COMPOSITIONS  
COMPOSIZIONI. COMPOSICIONES



COMPOSITION. COMPOSICIÓN  
Kankare hexagon 3D  
Kankare taco.















COMPOSITION. COMPOSICIÓN  
Kankare hexagon 3D  
Kankare taco.



COMPOSITION. COMPOSICIÓN  
Kankare chevron ivory  
Kankare chevron grey  
Kankare chevron vison  
Pieces are sold separately. Las piezas se venden por separado.

For more information, please contact our commercial department.  
Para más información, por favor, contacte con nuestro departamento comercial

# TECHNICAL CHARACTERISTICS.CARACTERÍSTICAS TÉCNICAS

MEASUREMENTS AND SURFACES APPEARANCE MEDIDAS Y ASPECTO SUPERFICIAL		STANDARD TEST METHOD STANDARD TEST METHOD	STANDARD PRESCRIBED VALUES STANDARDWERTE	KANKARE collection
	<b>Length and width.</b> Lunghezza e larghezza. Longitud y anchura. Länge und Breite	ISO 10545-2	± 0,6% max.	± 0,1%*
	<b>Orthogonality.</b> Ortogonalità. Ortogonalidad. Rechtwinkligkeit	ISO 10545-2	± 0,6% max.	± 0,2%*
	<b>Straightness of sides.</b> Rettilineità dei lati. Rectitud de lados. Kantengeradigkeit	ISO 10545-2	± 0,5% max.	± 0,2%*
	<b>Surfaces flatness.</b> Planarità. Planitud. Ebenflächigkeit	ISO 10545-2	± 0,5% max.	± 0,2%*
PHYSICAL PROPERTIES / PROPIEDADES FÍSICAS				
	<b>Water absorption.</b> Assorbimento d' acqua. Absorción de agua. Wasseraufnahme	ISO 10545-3	≤ 0,5%	< 0,1%
	<b>Breaking strength, in N.</b> Carico di rottura, in N. Carga de rotura, en N. Bruchlast, in N	ISO 10545-4	≥ 700 N	> 1400 N*
	<b>Modulus of rupture</b> Resistenza alla flessione. Resistencia a la flexión. Biegefestigkeit	ISO 10545-4	≥ 35 N/mm <sup>2</sup>	> 40 N/mm <sup>2</sup> *
	<b>Resistance to thermal shock.</b> Resistenza agli sbalzi termici. Resistencia al choque térmico. Temperaturwechselbeständigkeit	ISO 10545-9	No surface defects should be visible Non deve presentare difetti visibili No debe presentar defectos superficiales visibles	Resistant. Resistente. Resistente
	<b>Frost resistance.</b> Resistenza al gelo. Resistencia a la helada. Frostbeständigkeit	ISO 10545-12	No surface defects or cracks should be visible Non deve presentare difetti visibili No debe presentar defectos ni grietas superficiales visibles	Frost Resistant Antighiaccio Resistente a la Helada
	<b>Coefficient of friction.</b> Resistenza allo scivolamento. Coeficiente de fricción. Rutschfestigkeit	UNE - ENV 12633	WET TEST / ENSAYO EN HÚMEDO DRY TEST / ENSAYO EN SECO	CLASE I* DCOF - ANSIA 137.1-2012 > 0.42
	<b>Colour resistance to light.</b> Resistenza dei colori alla luce. Resistencia del color a la luz. Lichtbeständigkeit der Farben	DIN 51094	There should be no colour variations Non deve presentare difetti visibili No debe presentar variaciones de color	No alterations in colour and shine Non presenta alterazioni di colori e lucentezza No presenta variaciones de color y brillo
CHEMICAL PROPERTIES / PROPIEDADES QUÍMICAS				
	<b>Chemical resistance.</b> Resistenza agli agenti chimici. Resistencia química. Chemikalienbeständigkeit	ISO 10545-13	Resistance to household cleaning products and swimmingpools salts. Resistencia a productos domésticos y sales para piscinas.	Min. UB
	<b>Resistance to staining.</b> Resistenza alle macchie. Resistencia a las manchas. Fleckenbeständigkeit	ISO 10545-14	≥ 3	5

\* The Land values are the average of different production consignments. For further detail information, please check with our commercial network.

Los valores declarados son el promedio obtenido a través de ensayos de diferentes producciones. Para la obtención de una información detallada consultar a la red comercial.

For projects check technical information with our commercial networks. / Para proyectos obtenga información técnica a través de nuestra red comercial.

# 3Dimensional

SPECIAL PIECES.  
PEZZI SPECIALI. PIEZAS ESPECIALES

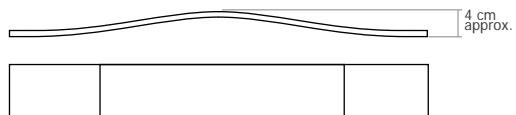

**UP**  
22,21x89,46 cm - 8.74"x35.22"

- Kankare Up 22,21x89,46 cm \* **G-5337**

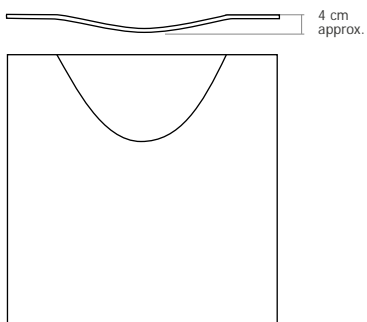

**BAG\***  
89,46 X 89,46 cm / 59,55x59,55 cm

- Kankare Bag 89,46x89,46 cm \* **G-5795**  
- Kankare Bag 44,63 x 89,46 cm \* **G-5599**

\* Available in all colours from Kankare collection.  
Disponible en todos los colores de la colección Kankare.

This is a natural product made through a handmade process, therefore, its possible shade or size variations must be considered as typical features of the material and they will not be admitted in a claim.

Este es un producto natural fabricado artesanalmente, por lo que posibles variaciones de tono o dimension deben considerarse propias del material y no será objeto de reclamación.

• INFO pag. 208

KANKARE

Kankare Vison Natural UP 22,21x89,46 cm

# MATTER



STONE



\* Matter ivory natural. Content of recycled material. Contenido de material reciclado.

## FORMATS.FORMATI.FORMATOS



**60X120**  
59,55x119,3 cm - 23.45"x46.97"



**60X60**  
59,55x59,55 cm - 23.45"x23.45"



**30X120**  
29,67x119,3 cm - 11.68"x46.97"



**30X60**  
29,75x59,55 cm - 11.71"x23.45"

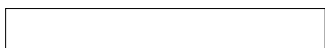

**15X120**  
14,73x119,3 cm - 5.80"x46.97"

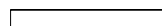

**7,5X60**  
7,3x59,55 cm - 2.87"x23.45"

## SPECIAL PIECES.PEZZI SPECIALI.PIEZAS ESPECIALES

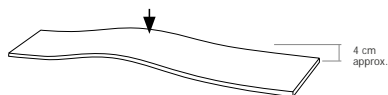

**15X120 UP**  
14,73x118,80 cm - 5.80"x46.77"

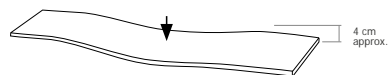

**15X120 DOWN**  
14,73x118,80 cm - 5.80"x46.77"

+ INFO pag. 208.



**30X30 mosaico 3,5x3,5**  
29,75x29,75 cm - 11.71"x11.71"



**30X30 mosaico 3D 3,5x10**  
29,75x29,75 cm - 11.71"x11.71"



**7,5X60 rodapié**  
7,3x59,55 cm - 2.87"x23.45"

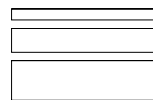

**15X60 - 10X60 - 5X60  
multiformat natural\***  
14,75x59,55 cm - 5.87"x23.45"  
9,72x59,55 cm - 3.83"x 23.45"  
4,84x59,55 cm - 1.90"x23.45"

\*The box contains 5 pieces from each of the formats.  
cada caja contiene 5 piezas de cada formato.

## THICKNESS.SPESSORE.ESPEORES

≡ 1,18 cm / 0.46" approx.      60x120 cm / 30x120 cm / 15x120 cm FORMATS  
≡ 1,03 cm / 0.40" approx.      30x60 cm / 60x60 cm FORMATS

## COLOURS COLORI COLORES

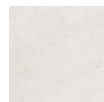

**Ivory**

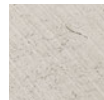

**Grey**

## FINISHES FINITURI ACABADOS



**Natural**

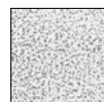

**Lappato**

# MATTER ivory

PLAIN TILES.BASE.BASES

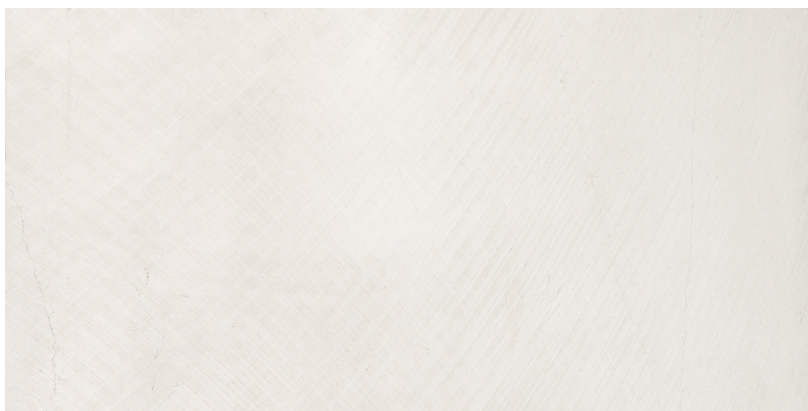

**Matter ivory natural**  
59,55 x 119,3 cm - 23.45" x 46.97"  
G-6506

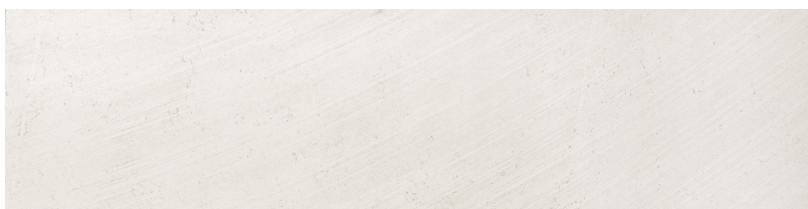

**Matter ivory natural**  
29,67 x 119,3 cm - 11.68" x 46.97"  
G-6544

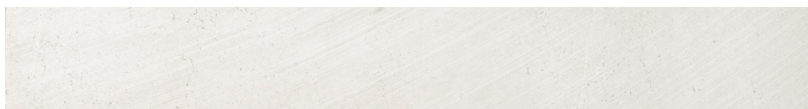

**Matter ivory natural**  
14,73 x 119,3 cm - 5.80" x 46.97"  
G-6584

**Matter lappato** **CLASE 2** **R10**  
UNE - ENV 12633 DIN 51130

**Matter natural** **CLASE 1**  
UNE - ENV 12633  
**DCOF>0.42**  
ANSI A 137.1 - 2012

## STEPS.GRADINI.PELDAÑOS

		natural		lappato		
SIMPLE		peldaño simple-30 (30x60 cm)	5171	-	-	
		peldaño simple-60 (30x60 cm)	5171	-	-	
		peldaño simple áng. (30x60 cm)	5187	-	-	
		peldaño simple-60 (60x60 cm)	5281	5281	-	-
		peldaño simple áng. (60x60 cm)	5299	5299	-	-
		peldaño simple 120 (30x120 cm)	5519	-	-	

		natural		lappato		
GRADONE		peldaño grad-30 (30x60 cm)	5559	-	-	
		peldaño grad-60 (30x60 cm)	5559	-	-	
		peldaño grad. áng (30x60 cm)	5609	-	-	
		peldaño grad-60 (60x60 cm)	5559	5559	-	-
		peldaño grad. áng (60x60 cm)	5609	5609	-	-
		peldaño grad-120 (30x120 cm)	5795	-	-	
		peldaño grad áng (30x120 cm)	5815	-	-	

		natural	
STEP		step 120 (30x120 cm)	5795
		step 60 (30x60 cm)	5559

+ INFO pag. 207.

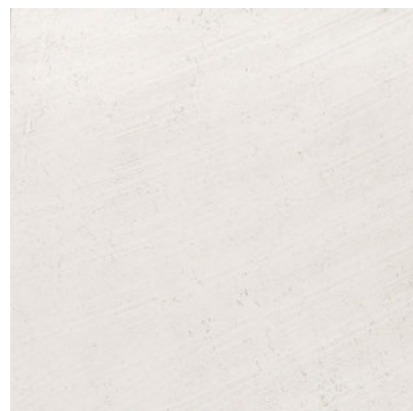

**Matter ivory natural / lappato**  
59,55 x 59,55 cm - 23.45" x 23.45"  
G-6286 / G-6330

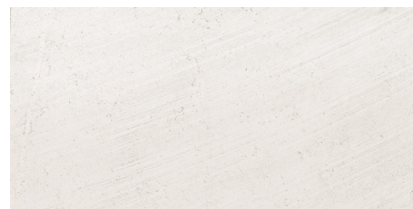

**Matter ivory natural**  
29,75 x 59,55 cm - 11.71" x 23.45"  
G-6218

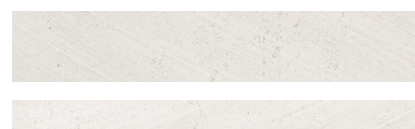
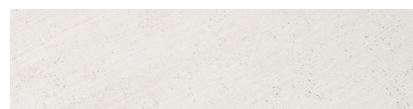

**Matter ivory natural multiformat 15x60-10x60-5x60\***  
14,75x59,55 cm - 5.87"x23.45"  
9,72x59,55 cm - 3.83"x 23.45"  
4,84x59,55 cm - 1.90"x23.45"  
G-6298



**Matter ivory natural / lappato listelo**  
7,3 x 59,55 cm - 2.87" x 23.45"  
G-5087 / G-5091

## SPECIAL PIECES. PEZZI SPECIALI. PIEZAS ESPECIALES

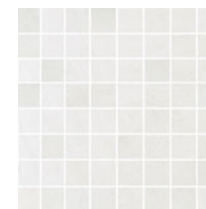

**Matter ivory natural**  
**mosaico 3,5x3,5**  
29,75 x 29,75 cm - 11.71" x 11.71"  
G-6756

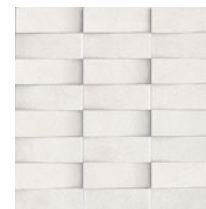

**Matter ivory natural**  
**mosaico 3D 3,5x10**  
29,75 x 29,75 cm - 11.71" x 11.71"  
G-5187

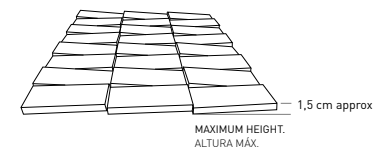

\*The box contains 5 pieces from each of the formats.  
cada caja contiene 5 piezas de cada formato.

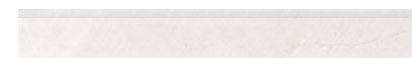

**Matter ivory natural rodapié 60**  
7,3 x 59,55 cm - 2.87" x 23.45"  
G-5097



MATTER

Matter Ivory Natural 59,55x59,55 cm

# MATTER grey

PLAIN TILES.BASE.BASES



**Matter grey natural**  
59,55 x 119,3 cm - 23.45" x 46.97"  
G-6506

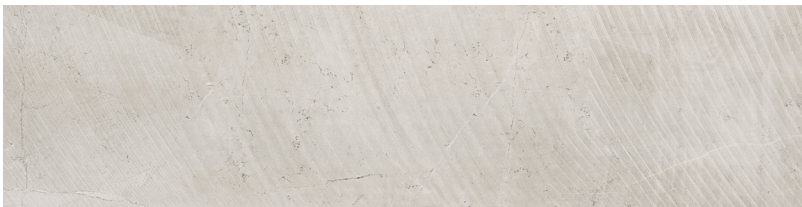

**Matter grey natural**  
29,67 x 119,3 cm - 11.68" x 46.97"  
G-6544

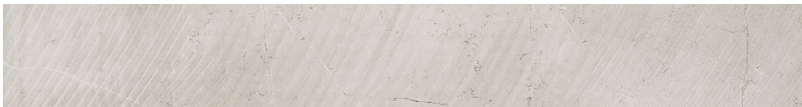

**Matter grey natural**  
14,73 x 119,3 cm - 5.80" x 46.97"  
G-6584

**Matter lappato** **CLASE 2** **R10**  
UNE - ENV 12633 DIN 51130

**Matter natural** **CLASE 1**  
UNE - ENV 12633  
**DCOF>0.42**  
ANSI A 137.1 - 2012

## STEPS.GRADINI.PELDAÑOS

			natural	lappato
SIMPLE		peldaño simple-30 [30x60 cm]	5171	-
		peldaño simple-60 [30x60 cm]	5171	-
		peldaño simple áng. [30x60 cm]	5187	-
		peldaño simple-60 [60x60 cm]	5281	5281
		peldaño simple áng. [60x60 cm]	5299	5299
		peldaño simple 120 [30x120 cm]	5519	-
GRADONE			natural	lappato
		peldaño grad-30 [30x60 cm]	5559	-
		peldaño grad-60 [30x60 cm]	5559	-
		peldaño grad. áng [30x60 cm]	5609	-
		peldaño grad-60 [60x60 cm]	5559	5559
		peldaño grad. áng [60x60 cm]	5609	5609
		peldaño grad-120 [30x120 cm]	5795	-
		peldaño grad áng [30x120 cm]	5815	-
STEP			natural	
		step 120 [30x120 cm]	5795	
		step 60 [30x60 cm]	5559	

+ INFO pag. 207.



**Matter grey natural / lappato**  
59,55 x 59,55 cm - 23.45" x 23.45"  
G-6286 / G-6330

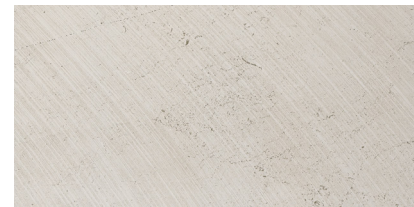

**Matter grey natural**  
29,75 x 59,55 cm - 11.71" x 23.45"  
G-6218

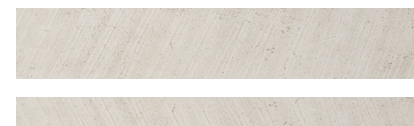
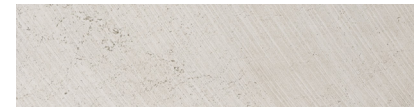

**Matter grey natural multiformat 15x60-10x60-5x60\***  
14,75x59,55 cm - 5.87"x23.45"  
9,72x59,55 cm - 3.83"x 23.45"  
4,84x59,55 cm - 1.90"x23.45"  
G-6298



**Matter grey natural / lappato listelo**  
7,3 x 59,55 cm - 2.87" x 23.45"  
G-5087 / G-5091

## SPECIAL PIECES. PEZZI SPECIALI. PIEZAS ESPECIALES



**Matter grey natural**  
**mosaico 3,5x3,5**  
29,75 x 29,75 cm - 11.71" x 11.71"  
G-6756

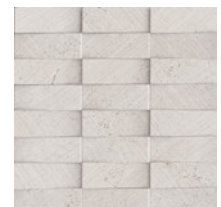

**Matter grey natural**  
**mosaico 3D 3,5x10**  
29,75 x 29,75 cm - 11.71" x 11.71"  
G-5187

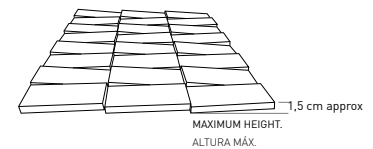

\*The box contains 5 pieces from each of the formats.  
cada caja contiene 5 piezas de cada formato.

















**Matter grey natural rodapié 60**  
7,3 x 59,55 cm - 2.87" x 23.45"  
G-5097



MATTER

Matter Grey Natural 59,55x119,3 cm

# TECHNICAL CHARACTERISTICS. CARATTERISTICHE TECNICHE. CARACTERÍSTICAS TÉCNICAS

MEASUREMENTS AND SURFACES APPEARANCE / DIMENSIONI E ASPETTO SUPERFICIALE / MEDIDAS Y ASPECTO SUPERFICIAL / MASSEN UND AUSSEHEN DER OBERFLÄCHE		STANDARD TEST METHOD METODO DELLA NORMA METODO DE ENSAYO STANDARD TEST METHOD	STANDARD PRESCRIBED VALUES VALORE PRESCRITTO VALORES STANDARD NORMA STANDARDWERTE	MATTER collection *
 Length and width. <i>Lunghezza e larghezza.</i> Longitud y anchura. Länge und Breite		ISO 10545-2	± 0,6% max.	± 0,1% *
 Thickness. <i>Spessore.</i> Grosor. Stärke		ISO 10545-2	± 5% max.	± 2% *
 90° Orthogonality. <i>Ortogonalità.</i> Ortogonalidad. Rechtwinkligkeit		ISO 10545-2	± 0,6% max.	± 0,2%
 Straightness of sides. <i>Rettilinearità dei lati.</i> Rectitud de lados. Kantengeradigkeit		ISO 10545-2	± 0,5% max.	± 0,2%
 Surfaces flatness. <i>Planarità.</i> Planitud. Ebenföchigkeit		ISO 10545-2	± 0,5% max.	± 0,2%
PHYSICAL PROPERTIES / PROPIETÀ FISICHE / PROPIEDADES FÍSICAS / PHYSIKALISCHE EIGENSCHAFTEN				
 Water absorption. <i>Assorbimento d'acqua.</i> Absorción de agua. Wasseraufnahme		ISO 10545-3	≤ 0,5%	≤ 0,1%
 Breaking strength, in N. <i>Carico di rottura, en N.</i> Carga de rotura, en N. Bruchlast, in N	thickness>7,5 mm spessore>7,5 mm grosor>7,5 mm	ISO 10545-4	≥ 1300 N	2400 N *
 Modulus of rupture. <i>Resistenza alla flessione.</i> Resistencia a la flexión. Biegefestigkeit		ISO 10545-4	≥ 35 N/mm <sup>2</sup>	56 N/mm <sup>2</sup> *
 Resistance to deep abrasion. <i>Resistenza all'abrasione profonda.</i> Resistencia a la abrasion profunda. Tiefverschleissbeständigkeit		ISO 10545-6	≤ 175 mm <sup>3</sup>	115 mm <sup>3</sup> *
 Resistance to thermal shock. <i>Resistenza agli sbalzi termici.</i> Resistencia al choque térmico. Temperaturwechselbeständigkeit		ISO 10545-9	No surface defects should be visible Non deve presentare difetti visibili No debe presentar defectos superficiales visibles	Resistant. Resistente. Resistente
 Frost resistance. <i>Resistenza al gelo.</i> Resistencia a la helada. Frostbeständigkeit		ISO 10545-12	No surface defects or cracks should be visible Non deve presentare difetti visibili No debe presentar defectos ni grietas superficiales visibles	Frost resistant Antighiaccio Resistente a la Helada
 Coefficient of friction. <i>Resistenza allo scivolamento.</i> Coeficiente de fricción. Rutschfestigkeit		DIN 51130 UNE - ENV 12633	WET TEST/ENSAYO EN HÚMEDO DRY TEST/ENSAYO EN SECO	R9** Clase 1** - Clase 2*** Clase 3**** DCOF - ANSIA 137.1-2012 > 0.42
 Colour resistance to light. <i>Resistenza dei colori alla luce.</i> Resistencia del color a la luz. Lichtbeständigkeit der Farben		DIN 51094	There should be no colour variations Non deve presentare difetti visibili No debe presentar variaciones de color	No alterations in colour and shine Non presenta alterazioni di colori e lucentezza No presenta variaciones de color y brillo
CHEMICAL PROPERTIES / PROPIETÀ CHIMICHE / PROPIEDADES QUÍMICAS / CHEMISCHEN EIGENSCHAFTEN				
 Chemical resistance. <i>Resistenza agli agenti chimici.</i> Resistencia química. Chemikalienbeständigkeit		ISO 10545-13	Resistance to household cleaning products and swimmingpools salts. Resistencia a productos domésticos y sales para piscinas	Min. UB
 Resistance to staining. <i>Resistenza alle macchie.</i> Resistencia a las manchas. Fleckenbeständigkeit		ISO 10545-14	≥ 3	5 *

\*The Land values are the average of different production consignments. For further detail information, please check with our commercial network. / I valori dichiarati sono ottenuti da una media di prove effettuate su diverse produzioni. Per avere informazioni dettagliate consultare la rete commerciale. / Los valores declarados son el promedio obtenido a través de ensayos de diferentes producciones. Para la obtención de una información detallada consultar a la red comercial.

\*\* R9 Test carried out on Matter Grey Natural 60x60 (Batch 17-10-12). Ensayo realizado sobre el producto Matter Grey Natural 60x60 (Lote 17-10-12)

\*\* Clase 1 - Tested in natural finish (It depends on the consignment). Test realized in internal laboratory / Provare realizzato in laboratorio interno / Ensayo realizado en laboratorio interno.

\*\*\* Clase 2 - Tested in lappato finish (It depends on the consignment) Test realized in internal laboratory / Provare realizzato in laboratorio interno / Ensayo realizado en laboratorio interno.

\*\*\*\* Dry Test, according to document DA DB-SUA/3 (Código Técnico de la Edificación) M° de Fomento. Average test result value, on May 2012. Ensayo realizado, según documento DA DB-SUA/3 (Código Técnico de la Edificación) M° de Fomento. Valor medio a fecha Mayo 2012.

# 3Dimensional

SPECIAL PIECES. PEZZI SPECIALI. PIEZAS ESPECIALES

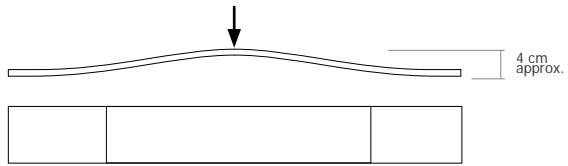

**UP**  
14,73x118,80 cm - 5.80"x46.77"

- Matter Up 14,73x118,80 cm \* **G-5435**

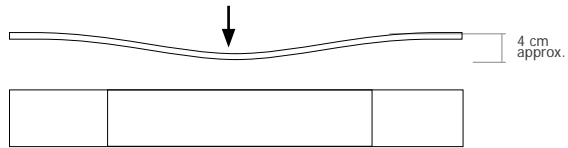

**DOWN**  
14,73x118,80 cm - 5.80"x46.77"

- Matter Down 14,73x118,80 cm \* **G-5435**

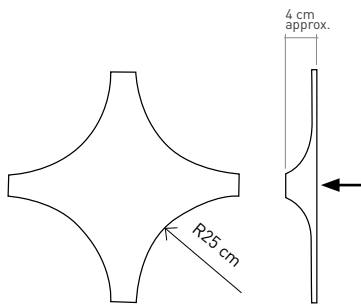

**STAR**  
59,55 x 58,88 cm - 23.45" x 23.18"

- Matter Star 59,55 x 58,88 cm\* **G-5435**

\* available in all colours from Matter collection.  
\*disponible en todos los colores de la colección Matter.  
+ INFO pag. 208

\*This is a natural product made through a handmade process, therefore, its possible shade or size variations must be considered as typical features of the material and they will not be admitted in a claim.

\*Este es un producto natural fabricado artesanalmente, por lo que posibles variaciones de tono o dimensión deben considerarse propias del material y no será objeto de reclamación.



Matter ivory Star 59,55 x 58,88 cm

# MATTER SLIM



STONE



\* Matter Slim ivory natural. Content of recycled material. Contenido de material reciclado.

## FORMATS.FORMATI.FORMATOS



30X90 natural  
29,75x89,46 cm - 11.71"x35.22"

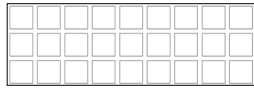

30X90 square  
29,75x89,46 cm - 11.71"x35.22"

## SPECIAL PIECES.PEZZI SPECIALI.PIEZAS ESPECIALES



30X30 mosaico 2,5x2,5  
29,75x29,75 cm - 11.71"x11.71"

## THICKNESS.SPESSORE.ESPESORES

 0,48 cm approx. / 0.19" approx.

## COLOURS COLORI COLORES



Ivory



Grey

## FINISHES FINITURI ACABADOS



Natural

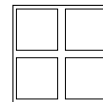

Square

# MATTER SLIM ivory

## PLAIN TILES.BASE.BASES



**Matter slim ivory natural**  
29,75 x 89,46 cm - 11.71" x 35.22"  
G-6224



**Matter slim ivory square**  
29,75 x 89,46 cm - 11.71" x 35.22"  
G-6246

## SPECIAL PIECES.PEZZI SPECIALI.PIEZAS ESPECIALES

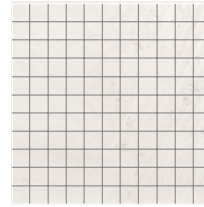

**Matter slim ivory natural  
mosaico 2,5x2,5**  
29,75 x 29,75 cm - 11.71" x 11.71"  
G-6756

## COMPLEMENTS.COMPLEMENTI.COMPLEMENTOS

**Fusion graffiato lista 90**  
1,5 x 89,46 cm - 0.59" x 35.22"



G-5091



MATTER SLIM

wall: Matter Slim Ivory Square - Grey Natural 29,75x89,46 cm  
floor: Matter Grey Lappato 59,55x59,55 cm

# MATTER SLIM grey

## PLAIN TILES.BASE.BASES



**Matter slim grey natural**  
29,75 x 89,46 cm - 11.71" x 35.22"  
G-6224



**Matter slim grey square**  
29,75 x 89,46 cm - 11.71" x 35.22"  
G-6246

## SPECIAL PIECES.PEZZI SPECIALI.PIEZAS ESPECIALES

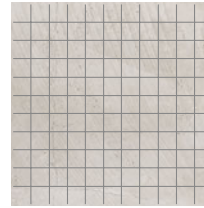

**Matter slim grey natural mosaico 2,5x2,5**  
29,75 x 29,75 cm - 11.71" x 11.71"  
G-6756

## COMPLEMENTS.COMPLEMENTI.COMPLEMENTOS



**Fusion graffiato lista 90**  
1,5 x 89,46 cm - 0.59" x 35.22"



G-5091



MATTER SLIM

wall: Matter Slim Ivory Natural - Ivory Square - Grey Square 29,75x89,46 cm  
floor: Matter Grey Natural 59,55x119,3\_29,67x119,3\_14,73x119,3 cm

# TECHNICAL CHARACTERISTICS.CARATTERISTICHE TECNICHE.CARACTERÍSTICAS TÉCNICAS

MEASUREMENTS AND SURFACES APPEARANCE / DIMENSIONI E ASPETTO SUPERFICIALE / MEDIDAS Y ASPECTO SUPERFICIAL / MASSEN UND AUSSEHEN DER OBERFLÄCHE		STANDARD TEST METHOD METODO DELLA NORMA METODO DE ENSAYO STANDARD TEST METHOD	STANDARD PRESCRIBED VALUES VALORE PRESCRITTO VALORES STANDARD NORMA STANDARDWERTE	<b>Matter Slim</b> *
Length and width. <i>Lunghezza e larghezza.</i> Longitud y anchura. Länge und Breite		ISO 10545-2	± 0,6% max.	± 0,1% *
Orthogonality. <i>Ortogonalità.</i> Ortogonalidad. Rechtwinkligkeit		ISO 10545-2	± 0,6% max.	± 0,2% *
Straightness of sides. <i>Rettilinearità dei lati.</i> Rectitud de lados. Kantengeradigkeit		ISO 10545-2	± 0,5% max.	± 0,2% *
Surfaces flatness. <i>Planarità.</i> Planitud. Ebenföchigkeit		ISO 10545-2	± 0,5% max.	± 0,2% *
PHYSICAL PROPERTIES / PROPIETÀ FISICHE / PROPIEADADES FÍSICAS / PHYSIKALISCHE EIGENSCHAFTEN				
Water absorption. <i>Assorbimento d' acqua.</i> Absorción de agua. Wasseraufnahme		ISO 10545-3	≤ 0,5%	0,1%
Breaking strength, in N. <i>Carico di rottura, en N.</i> Carga de rotura, en N. Bruchlast, in N	thickness <75 mm spessore <7,5 mm grosor <7,5 mm	ISO 10545-4	≥ 700 N	Available Method * Metodo Disponibile Método Disponible
Modulus of rupture <i>Resistenza alla flessione.</i> Resistencia a la flexión. Biegefestigkeit		ISO 10545-4	≥ 35 N/mm <sup>2</sup>	>40 N/mm <sup>2</sup> *
Resistance to thermal shock. <i>Resistenza agli sbalzi termici.</i> Resistencia al choque térmico. Temperaturwechselbeständigkeit		ISO 10545-9	No surface defects should be visible Non deve presentare difetti visibili No debe presentar defectos superficiales visibles	Resistant. Resistente. Resistente
Frost resistance. <i>Resistenza al gelo.</i> Resistencia a la helada. Frostbeständigkeit		ISO 10545-12	No surface defects or cracks should be visible Non deve presentare difetti visibili No debe presentar defectos ni grietas superficiales visibles	Frost Resistant Antighaccio Resistente a la Helada
Coefficient of friction. <i>Resistenza allo scivolamento.</i> Coeficiente de fricción. Rutschfestigkeit		DIN 51130		Available Method Metodo Disponibile Método Disponible
Colour resistance to light. <i>Resistenza dei colori alla luce.</i> Resistencia del color a la luz. Lichtbeständigkeit der Farben		DIN 51094	There should be no colour variations Non deve presentare difetti visibili No debe presentar variaciones de color	No alterations in colour and shine Non presenta alterazioni di colore e lucentezza No presenta variaciones de color y brillo
CHEMICAL PROPERTIES / PROPIETÀ CHIMICHE / PROPIEADADES QUÍMICAS / CHEMISCHEN EIGENSCHAFTEN				
Chemical resistance. <i>Resistenza agli agenti chimici.</i> Resistencia química. Chemikalienbeständigkeit		ISO 10545-13	Resistance to household cleaning products and swimmingpools salts. Resistencia a productos de limpieza y sales para piscinas	Min.GB
Resistance to staining. <i>Resistenza alle macchie.</i> Resistencia a las manchas. Fleckenbeständigkeit		ISO 10545-14	≥ 3	5 *

\*The Land values are the average of different production consignments. For further detail information, please check with our commercial network.  
I valori dichiarati sono ottenuti da una media di prove effettuate su diverse produzioni. Per avere informazioni dettagliate consultare la rete commerciale /  
Los valores declarados son el promedio obtenido a través de ensayos de diferentes producciones. Para la obtención de una información detallada consultar a la red comercial.

## ADVANTAGES.VANTAGGI.VENTAJAS

- Time. *Tempo.* Tiempo
- Money. *Denaro.* Dinero
- Hygiene. *Igiene.* Higiene
- Ecologic. *Ecologia.* Ecología
- Technology. *Tecnologia.* Tecnología

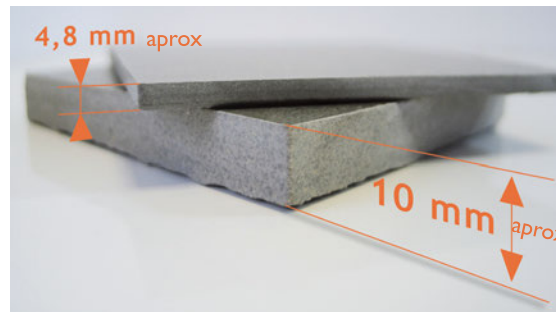

\* Recommended only for wall./  
sólo recomendado como revestimiento.



MATTER SLIM

Matter Slim Ivory Natural - Ivory Square 29,75x89,46 cm

# PIETRA SERENA



STONE



FJORDPIREN HINNA PARK  
Stavanger. (NORWAY)  
ARCH: LUND HAGEM

\* Pietra Serena ivory natural. Content of recycled material. Contenido de material reciclado.

## FORMATS.FORMATI.FORMATOS



**45X90**  
44,63x89,46 cm - 17.57"x35.22"



**22,5X90**  
22,21x89,46 cm - 8.75"x35.22"



**60X60**  
59,55x59,55 cm  
23.45"x23.45"



**30X60**  
29,75x59,55 cm  
11.71"x23.45"



**15X60**  
14,8x59,55 cm - 5.8"x23.45"



**10X60**  
9,6x59,55 cm - 3.78"x23.45"



**7,5X60**  
7,3x59,55 cm - 2.87"x23.45"

## SPECIAL PIECES.PEZZI SPECIALI.PIEZAS ESPECIALES

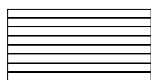

**30X60 preincisión 3,5x60**  
29,75x59,55 cm - 11.71"x23.45"

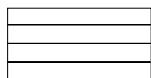

**30X60 preincisión 7,5x60**  
29,75x59,55 cm - 11.71"x23.45"

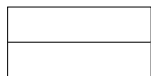

**30X60 preincisión 15x60**  
29,75x59,55 cm - 11.71"x23.45"



**30X60 preincisión irregular**  
29,75x59,55 cm - 11.71"x23.45"



**30X30 mosaico 3,5x3,5**  
29,75x29,75 cm - 11.71"x11.71"



**30X30 mosaico 3,5x3,5**  
29,75x29,75 cm - 11.71"x11.71"



**30X30 decor**  
29,75x29,75 cm - 11.71"x11.71"



**muretto**  
14,56x29,75 cm  
5.73"x11.71"



**30X60 you rigato silver/gold**  
29,75x59,55 cm - 11.71"x23.45"



**7,5X60 rodapié**  
7,3x59,55 cm - 2.87"x23.45"

## THICKNESS.SPESSORE.ESPEORES

≡ 1,11 cm / 0.44" approx.

≡ 1,03 cm / 0.40" approx.

45x90 cm / 22,5x90 cm FORMATS

30x60 cm / 60x60 cm FORMATS

## COLOURS COLORI COLORES

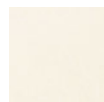

**Ivory**

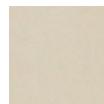

**Beige**



**Moss**

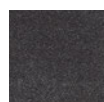

**Graphite**

## FINISHES FINITURI ACABADOS



**natural**

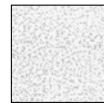

**lappato**

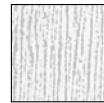

**filosega**

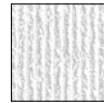

**rigato**



**bocciardato**

# PIETRA SERENA ivory

## PLAIN TILES.BASE.BASES



**Pietra Serena ivory natural**  
44,63 x 89,46 cm - 17.57" x 35.22"  
G-6410

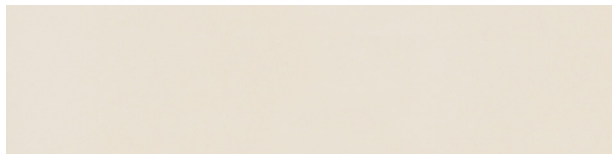

**Pietra Serena ivory natural**  
22,21 x 89,46 cm - 8.75" x 35.22"  
G-6456

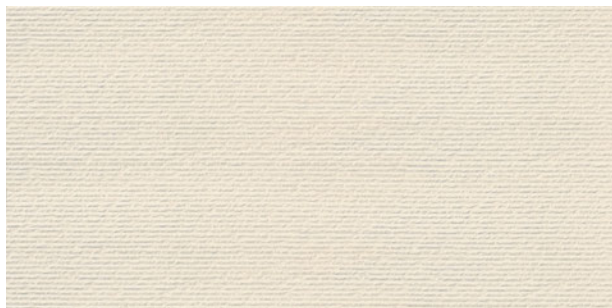

**Pietra Serena ivory rigato**  
44,63 x 89,46 cm - 17.57" x 35.22"  
G-6446

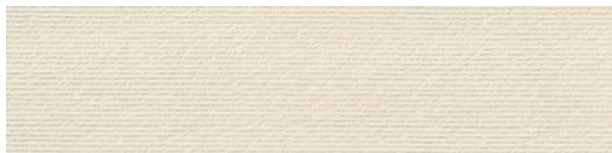

**Pietra Serena ivory rigato**  
22,21 x 89,46 cm - 8.75" x 35.22"  
G-6476



**Pietra Serena ivory natural / lappato**  
59,55 x 59,55 cm - 23.45" x 23.45"  
G-6410 / 6446

Our product reproduces the natural beauty of the stones, they imitate their veins in order to get realism.

Le nostre pezze simulano la bellezza naturale delle pietre e per questo imitano la sua venatura che gli dà un'apparenza reale.

Nuestro producto reproduce la belleza natural de las piedras, imitando sus vetas para obtener mayor realismo.

**Pietra Serena natural**

**CLASE 1**

UNE - ENV 12633

**R9**

DIN 51130

**DCOF>0.42**

ANSI A 137.1 - 2012

**Pietra Serena filosega**

**CLASE 3**

UNE - ENV 12633

**R11**

DIN 51130

**Pietra Serena rigato**

**CLASE 3**

UNE - ENV 12633

**R11**

DIN 51130

**Pietra Serena bocciardato**

**CLASE 3**

UNE - ENV 12633

**R12**

DIN 51130

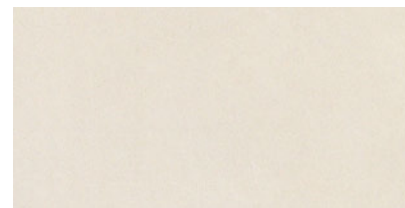

**Pietra Serena ivory natural / lappato**  
29,75 x 59,55 cm - 11.71" x 23.45"  
G-6298 / 6330



**Pietra Serena ivory filosega**  
29,75 x 59,55 cm - 11.71" x 23.45"  
G-6330

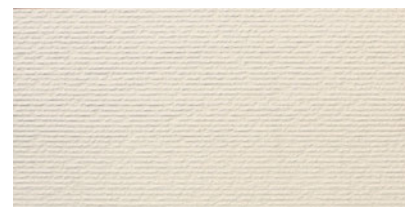

**Pietra Serena ivory rigato**  
29,75 x 59,55 cm - 11.71" x 23.45"  
G-6330

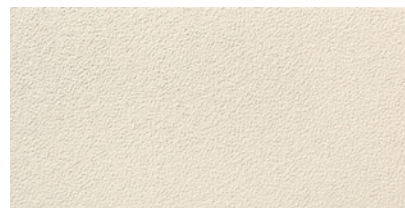

**Pietra Serena ivory bocciardato**  
29,75 x 59,55 cm - 11.71" x 23.45"  
G-6330

## SPECIAL PIECES. PEZZI SPECIALI. PIEZAS ESPECIALES

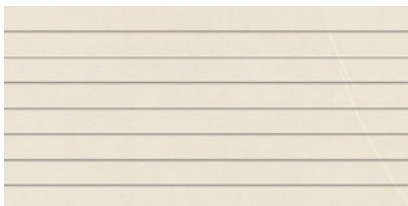

**Pietra Serena ivory lappato / rigato / bocciardato / filosega preincisión 3,5x60**  
29,75 x 59,55 cm - 11.71" x 23.45"  
G-6486 / 6486 / 6486 / 6486



**Pietra Serena ivory lappato / rigato / bocciardato / filosega preincisión 7,5x60**  
29,75 x 59,55 cm - 11.71" x 23.45"  
G-6458 / 6458 / 6458 / 6458

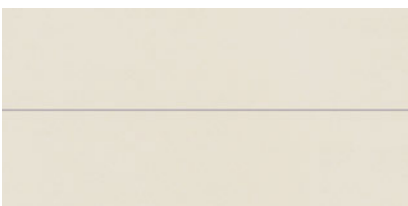

**Pietra Serena ivory lappato / rigato / bocciardato / filosega preincisión 15x60**  
29,75 x 59,55 cm - 11.71" x 23.45"  
G-6458 / 6458 / 6458 / 6458



**Pietra Serena ivory lappato / filosega preincisión irregular**  
29,75 x 59,55 cm - 11.71" x 23.45"  
G-5195 / 5195

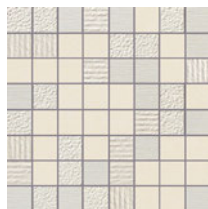

**Pietra Serena ivory multitex mosaico 3,5x3,5**  
29,75 x 29,75 cm - 11.71" x 11.71"  
G-6768

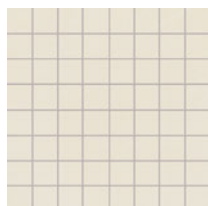

**Pietra Serena ivory lappato mosaico 3,5x3,5**  
29,75 x 29,75 cm - 11.71" x 11.71"  
G-6756

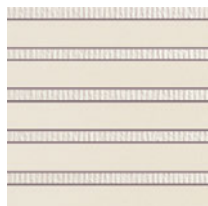

**Pietra Serena ivory rigato / bocciardato decor**  
29,75 x 29,75 cm - 11.71" x 11.71"  
G-6708 / 6708

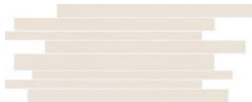

**Pietra Serena ivory lappato muretto**  
14,56 x 29,75 cm - 5.73" x 11.71"  
G-5131



**Pietra Serena ivory lappato / rigato / bocciardato listelo**  
7,3 x 59,55 cm - 2.87" x 23.45"  
G-5091 / 5091 / 5091



**Pietra Serena ivory rigato / bocciardato cenefa-1**  
9,6 x 59,55 cm - 3.78" x 23.45"  
G-5097 / 5097

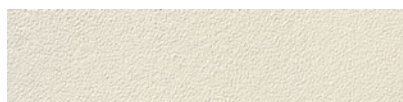

**Pietra Serena ivory rigato / bocciardato cenefa-3**  
14,8 x 59,55 cm - 5.8" x 23.45"  
G-5097 / 5097



**Pietra Serena ivory natural rodapié**  
7,3 x 59,55 cm - 2.87" x 23.45"  
G-5097

## COMPLEMENTS.COMPLEMENTI. COMPLEMENTOS

Complements complete list on page 205.  
Lista completa de complementos en página 205.

## STEPS.GRADINI.PELDAÑOS

		natural	lappato	bocciard.	filosega	rigato
SIMPLE	peldaño simple-30 (30x60 cm)	5171	5195	5195	5195	5195
	peldaño simple-60 (30x60 cm)	5171	5195	5195	5195	5195
	peldaño simple áng. (30x60 cm)	5187	5211	5211	5211	5211
	peldaño simple-60 (60x60 cm)	5281	5281	-	-	-
	peldaño simple áng. (60x60 cm)	5299	5299	-	-	-
	peldaño simple (45x90 cm)	5323	-	-	-	-
peldaño simple áng. (45x90 cm)	5333	-	-	-	-	

		natural	lappato	bocciard.	filosega	rigato
GRADONE	peldaño grad-30 (30x60 cm)	5559	5559	5559	5559	5559
	peldaño grad-60 (30x60 cm)	5559	5559	5559	5559	5559
	peldaño grad áng. (30x60 cm)	5609	5609	5609	5609	5609
	peldaño grad. (60x60 cm)	5559	5559	-	-	-
	peldaño grad áng. (60x60 cm)	5609	5609	-	-	-
	peldaño grad-90 (45x90 cm)	5623	-	-	-	-

+ INFO pag. 207.

# PIETRA SERENA beige

## PLAIN TILES.BASE.BASES

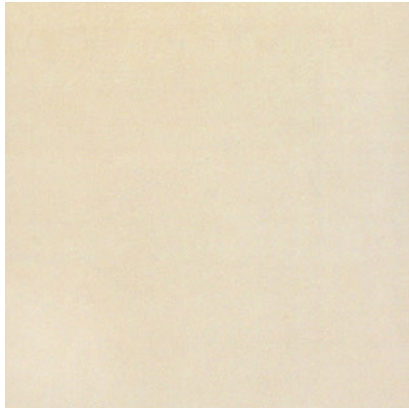

**Pietra Serena beige natural**  
59,55 x 59,55 cm - 23.45" x 23.45"  
G-6410 / 6446

Our product reproduces the natural beauty of the stones, they imitate their veins in order to get realism.

Le nostre pezze simulano la bellezza naturale delle pietre e per questo imitano la sua venatura che gli dà un'aspetto reale.

Nuestro producto reproduce la belleza natural de las piedras, imitando sus vetas para obtener mayor realismo.



**Pietra Serena beige natural / lappato**  
29,75 x 59,55 cm - 11.71" x 23.45"  
G-6298 / 6330

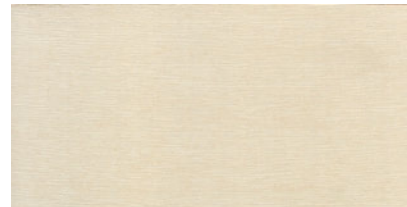

**Pietra Serena beige filosega**  
29,75 x 59,55 cm - 11.71" x 23.45"  
G-6330



**Pietra Serena beige rigato**  
29,75 x 59,55 cm - 11.71" x 23.45"  
G-6330

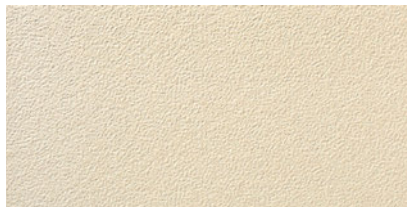

**Pietra Serena beige bocciardato**  
29,75 x 59,55 cm - 11.71" x 23.45"  
G-6330

<b>Pietra Serena natural</b>	<b>CLASE 1</b>	<b>R9</b>
	UNE - ENV 12633	DIN 51130
<b>DCOF&gt;0.42</b>		
ANSI A 137.1 - 2012		

<b>Pietra Serena filosega</b>	<b>CLASE 3</b>	<b>R11</b>
	UNE - ENV 12633	DIN 51130

<b>Pietra Serena rigato</b>	<b>CLASE 3</b>	<b>R11</b>
	UNE - ENV 12633	DIN 51130

<b>Pietra Serena bocciardato</b>	<b>CLASE 3</b>	<b>R12</b>
	UNE - ENV 12633	DIN 51130

## SPECIAL PIECES. PEZZI SPECIALI.PIEZAS ESPECIALES

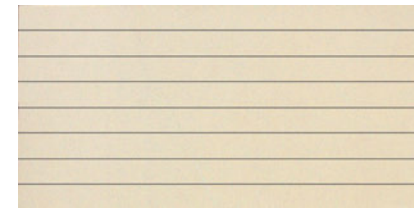

**Pietra Serena beige lappato / rigato / bocciardato / filosega precisión 3,5x60**  
29,75 x 59,55 cm - 11.71" x 23.45"  
G-6486 / 6486 / 6486 / 6486



**Pietra Serena beige lappato / rigato / bocciardato / filosega precisión 7,5x60**  
29,75 x 59,55 cm - 11.71" x 23.45"  
G-6458 / 6458 / 6458 / 6458

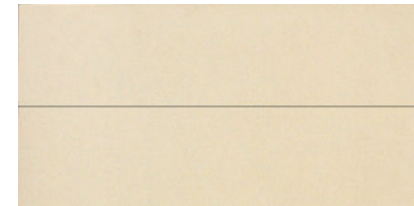

**Pietra Serena beige lappato / rigato / bocciardato / filosega precisión 15x60**  
29,75 x 59,55 cm - 11.71" x 23.45"  
G-6458 / 6458 / 6458 / 6458



**Pietra Serena beige lappato / filosega precisión irregular**  
29,75 x 59,55 cm - 11.71" x 23.45"  
G-5195 / 5195

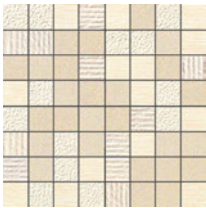

**Pietra Serena beige multitex mosaico 3,5x3,5**  
29,75 x 29,75 cm - 11.71" x 11.71"  
G-6768

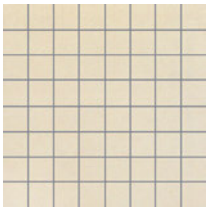

**Pietra Serena beige lappato mosaico 3,5x3,5**  
29,75 x 29,75 cm - 11.71" x 11.71"  
G-6754



**Pietra Serena beige rigato decor / bocciardato decor**  
29,75 x 29,75 cm - 11.71" x 11.71"  
G-6708 / 6708



**Pietra Serena beige lappato muretto**  
14,56 x 29,75 cm - 5.73" x 11.71"  
G-5131



**Pietra Serena beige lappato / rigato / bocciardato listelo**  
7,3 x 59,55 cm - 2.87" x 23.45"  
G-5091 / 5091 / 5091



**Pietra Serena beige rigato / bocciardato cenefa-1**  
9,6 x 59,55 cm - 3.78" x 23.45"  
G-5097 / 5097

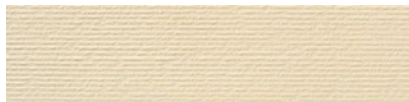

**Pietra Serena beige rigato / bocciardato cenefa-3**  
14,8 x 59,55 cm - 5.8" x 23.45"  
G-5097 / 5097



**Pietra Serena beige natural rodapié**  
7,3 x 59,55 cm - 2.87" x 23.45"  
G-5097

## STEPS.GRADINI.PELDAÑOS

		natural	lappato	bocciard	filosega	rigato
SIMPLE	peldaño simple-30 (30x60 cm)	5171	5195	5195	5195	5195
	peldaño simple-60 (30x60 cm)	5171	5195	5195	5195	5195
	peldaño simple áng. (30x60 cm)	5187	5211	5211	5211	5211
	peldaño simple-60 (60x60 cm)	5281	5281	-	-	-
	peldaño simple áng. (60x60 cm)	5299	5299	-	-	-

		natural	lappato	bocciard	filosega	rigato
GRADONE	peldaño grad-30 (30x60 cm)	5559	5559	5559	5559	5559
	peldaño grad-60 (30x60 cm)	5559	5559	5559	5559	5559
	peldaño grad áng. (30x60 cm)	5609	5609	5609	5609	5609
	peldaño grad. (60x60 cm)	5559	5559	-	-	-
	peldaño grad áng. (60x60 cm)	5609	5609	-	-	-

+ INFO pag. 207.

## COMPLEMENTS.COMPLEMENTI. COMPLEMENTOS

Complements complete list on page 205.  
Lista completa de complementos en página 205.



PIETRA SERENA

ALFONSO I HOTEL\*\*\*\*  
Zaragoza. (SPAIN)  
INT. DESIGN: PASCUA ORTEGA

# PIETRA SERENA moss

## PLAIN TILES.BASE.BASES



**Pietra Serena moss natural / lappato**  
59,55 x 59,55 cm - 23.45" x 23.45"  
G-6372 / 6410

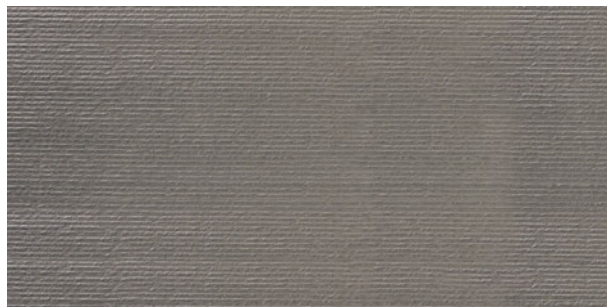

**Pietra Serena moss rigato**  
44,63 x 89,46 cm - 17.57" x 35.22"  
G-6410



**Pietra Serena moss rigato**  
29,75 x 59,55 cm - 11.71" x 23.45"  
G-6298



**Pietra Serena moss natural / lappato**  
29,75 x 59,55 cm - 11.71" x 23.45"  
G-6258 / 6298

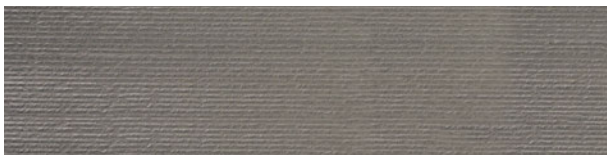

**Pietra Serena moss rigato**  
22,21 x 89,46 cm - 8.75" x 35.22"  
G-6456

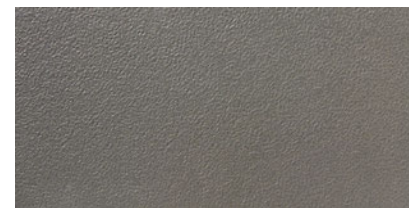

**Pietra Serena moss bocciardato**  
29,75 x 59,55 cm - 11.71" x 23.45"  
G-6298

**Pietra Serena natural**

**CLASE 1**

**R9**

UNE - ENV 12633 DIN 51130

**DCOF>0.42**

ANSI A 137.1 - 2012

**Pietra Serena filosega**

**CLASE 3**

**R11**

UNE - ENV 12633 DIN 51130

**Pietra Serena rigato**

**CLASE 3**

**R11**

UNE - ENV 12633 DIN 51130

**Pietra Serena bocciardato**

**CLASE 3**

**R12**

UNE - ENV 12633 DIN 51130

## SPECIAL PIECES. PEZZI SPECIALI. PIEZAS ESPECIALES

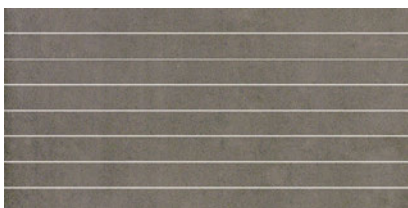

**Pietra Serena moss lappato / rigato / bocciardato preincisión 3,5x60**  
29,75 x 59,55 cm - 11.71" x 23.45"  
G-6486 / 6486 / 6486 / 6486

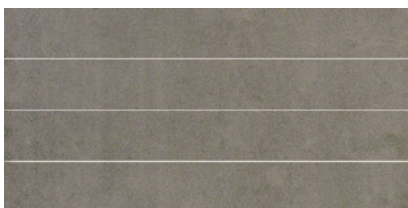

**Pietra Serena moss lappato / rigato / bocciardato preincisión 7,5x60**  
29,75 x 59,55 cm - 11.71" x 23.45"  
G-6458 / 6458 / 6458 / 6458

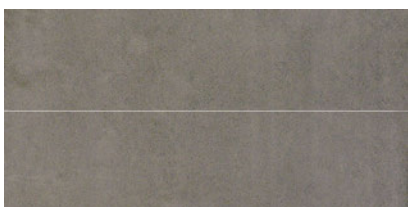

**Pietra Serena moss lappato / rigato / bocciardato preincisión 15x60**  
29,75 x 59,55 cm - 11.71" x 23.45"  
G-6458 / 6458 / 6458 / 6458



**Pietra Serena moss lappato preincisión irregular**  
29,75 x 59,55 cm - 11.71" x 23.45"  
G-5195 / 5195

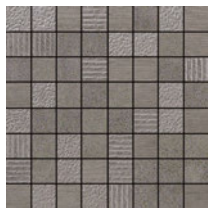

**Pietra Serena moss multitex mosaico 3,5x3,5**  
29,75 x 29,75 cm - 11.71" x 11.71"  
G-6768

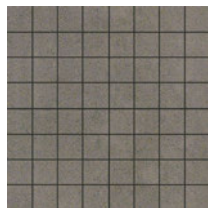

**Pietra Serena moss lappato mosaico 3,5x3,5**  
29,75 x 29,75 cm - 11.71" x 11.71"  
G-6756



**Pietra Serena moss rigato decor / bocciardato decor**  
29,75 x 29,75 cm - 11.71" x 11.71"  
G-6708 / 6708



**Pietra Serena moss lappato muretto**  
14,56 x 29,75 cm - 5.73" x 11.71"  
G-5131

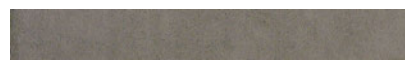

**Pietra Serena moss lappato / rigato / bocciardato listelo**  
7,3 x 59,55 cm - 2.87" x 23.45"  
G-5091 / 5091 / 5091



**Pietra Serena moss rigato / bocciardato cenefa-1**  
9,60 x 59,55 cm - 3.78" x 23.45"  
G-5097 / 5097

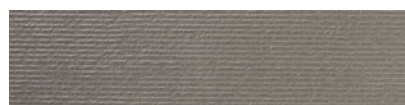

**Pietra Serena moss rigato / bocciardato cenefa-3**  
14,8 x 59,55 cm - 5.8" x 23.45"  
G-5097 / 5097



**Pietra Serena moss natural rodapié**  
7,3 x 59,55 cm - 2.87" x 23.45"  
G-5097

## COMPLEMENTS.COMPLEMENTI.COMPLEMENTOS

Complements complete list on page 205.  
Lista completa de complementos en página 205.

## STEPS.GRADINI.PELDAÑOS

		natural	lappato	bocciard	filosega	rigato
SIMPLE	peldaño simple-30 (30x60 cm)	5171	5195	5195	5195	5195
	peldaño simple-60 (30x60 cm)	5171	5195	5195	5195	5195
	peldaño simple áng. (30x60 cm)	5187	5211	5211	5211	5211
	peldaño simple-60 (60x60 cm)	5281	5281	-	-	-
	peldaño simple áng. (60x60 cm)	5299	5299	-	-	-
	peldaño simple (45x90 cm)	5323	-	-	-	-
peldaño simple áng. (45x90 cm)	5333	-	-	-	-	

		natural	lappato	bocciard	filosega	rigato
GRADONE	peldaño grad-30 (30x60 cm)	5559	5559	5559	5559	5559
	peldaño grad-60 (30x60 cm)	5559	5559	5559	5559	5559
	peldaño grad áng. (30x60 cm)	5609	5609	5609	5609	5609
	peldaño grad. (60x60 cm)	5559	5559	-	-	-
	peldaño grad áng. (60x60 cm)	5609	5609	-	-	-
	peldaño grad-90 (45x90 cm)	5623	-	-	-	-

+ INFO pag. 207.

# PIETRA SERENA **graphite**

## PLAIN TILES.BASE.BASES



**Pietra Serena graphite natural / lappato**  
59,55 x 59,55 cm - 23.45" x 23.45"

G-6372 / 6410

Our product reproduces the natural beauty of the stones, they imitate their veins in order to get realism.

Le nostre pezze simulano la bellezza naturale delle pietre e per questo imitano la sua venatura che gli dà un'apparenza reale.

Nuestro producto reproduce la belleza natural de las piedras, imitando sus vetas para obtener mayor realismo.

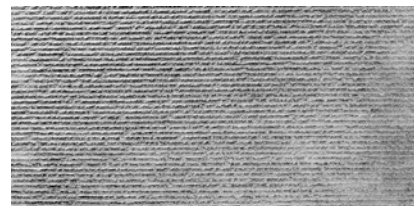

**You silver rigato\***

29,75 x 59,55 cm - 11.71" x 23.45"

G-5401

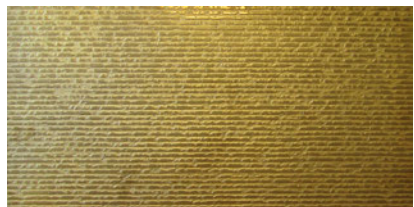

**You gold rigato\***

29,75 x 59,55 cm - 11.71" x 23.45"

G-5401

\* Physical Vapor Deposition [PVD]. Aplicación PVD.  
More information on page 221. Más información en página 221.

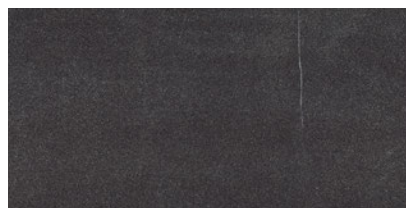

**Pietra Serena graphite natural / lappato**

29,75 x 59,55 cm - 11.71" x 23.45"

G-6258 / 6298



**Pietra Serena graphite filosega**

29,75 x 59,55 cm - 11.71" x 23.45"

G-6298

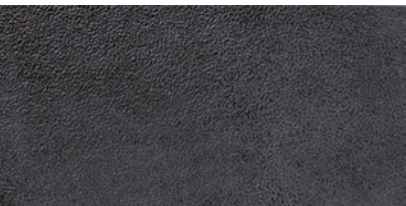

**Pietra Serena graphite bocciardato**

29,75 x 59,55 cm - 11.71" x 23.45"

G-6298

**Pietra Serena natural**

**CLASE 1 R9**

UNE - ENV 12633 DIN 51130

**DCOF>0.42**

ANSI A 137.1 - 2012

**Pietra Serena filosega**

**CLASE 3 R11**

UNE - ENV 12633 DIN 51130

**Pietra Serena rigato**

**CLASE 3 R11**

UNE - ENV 12633 DIN 51130

**Pietra Serena bocciardato**

**CLASE 3 R12**

UNE - ENV 12633 DIN 51130

## SPECIAL PIECES.

## PEZZI SPECIALI.PIEZAS ESPECIALES



**Pietra Serena graphite lappato / bocciardato / filosega preincisión 3,5x60**

29,75 x 59,55 cm - 11.71" x 23.45"

G-6486 / 6486 / 6486 / 6486



**Pietra Serena graphite lappato / bocciardato / filosega preincisión 7,5x60**

29,75 x 59,55 cm - 11.71" x 23.45"

G-6458 / 6458 / 6458 / 6458



**Pietra Serena graphite lappato / bocciardato / filosega preincisión 15x60**

29,75 x 59,55 cm - 11.71" x 23.45"

G-6458 / 6458 / 6458 / 6458



**Pietra Serena graphite lappato / filosega preincisión irregular**

29,75 x 59,55 cm - 11.71" x 23.45"

G-5195 / 5195

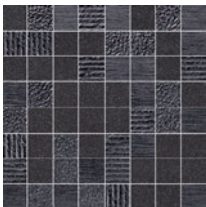

**Pietra Serena graphite multitex mosaico 3,5x3,5**  
29,75 x 29,75 cm - 11.71" x 11.71"  
G-6768

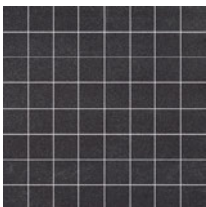

**Pietra Serena graphite lappato mosaico 3,5x3,5**  
29,75 x 29,75 cm - 11.71" x 11.71"  
G-6756

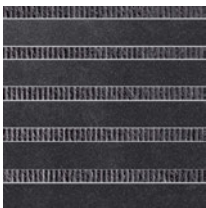

**Pietra Serena graphite bocciardato decor**  
29,75 x 29,75 cm - 11.71" x 11.71"  
G-6708 / 6708



**Pietra Serena graphite lappato muretto**  
14,56 x 29,75 cm - 5.73" x 11.71"  
G-5131



**Pietra Serena graphite lappato / bocciardato listelo**  
7,3 x 59,55 cm - 2.87" x 23.45"  
G-5091 / 5091 / 5091



**Pietra Serena graphite bocciardato cenefa-1**  
9,6 x 59,55 cm - 3.78" x 23.45"  
G-5097 / 5097

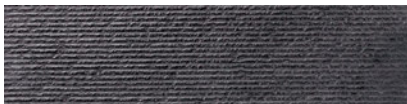

**Pietra Serena graphite bocciardato cenefa-3**  
14,8 x 59,55 cm - 5.8" x 23.45"  
G-5097 / 5097



**Pietra Serena graphite natural rodapié**  
7,3 x 59,55 cm - 2.87" x 23.45"  
G-5097

## STEPS.GRADINI.PELDAÑOS

		natural	lappato	bocciard	filosega	rigato
SIMPLE	peldaño simple-30 (30x60 cm)	5171	5195	5195	5195	5195
	peldaño simple-60 (30x60 cm)	5171	5195	5195	5195	5195
	peldaño simple áng. (30x60 cm)	5187	5211	5211	5211	5211
	peldaño simple-60 (60x60 cm)	5281	5281	-	-	-
	peldaño simple áng. (60x60 cm)	5299	5299	-	-	-

		natural	lappato	bocciard	filosega	rigato
GRADONE	peldaño grad-30 (30x60 cm)	5559	5559	5559	5559	5559
	peldaño grad-60 (30x60 cm)	5559	5559	5559	5559	5559
	peldaño grad áng. (30x60 cm)	5609	5609	5609	5609	5609
	peldaño grad. (60x60 cm)	5559	5559	-	-	-
	peldaño grad áng. (60x60 cm)	5609	5609	-	-	-

+ INFO pag. 207.

## COMPLEMENTS.COMPLEMENTI. COMPLEMENTOS

Complements complete list on page 205.  
Lista completa de complementos en página 205.



NOVOTEL HOTEL  
Lisbon. (PORTUGAL)



PRIVATE HOUSE  
 Portocolom, Mallorca (SPAIN)  
 Arch. JOCHEN LENDLE, JLE Arquitectos

Pietra Serena Ivory Natural 29,75x59,55 cm  
 Pietra Serena Ivory Rigato 29,75x59,55 cm

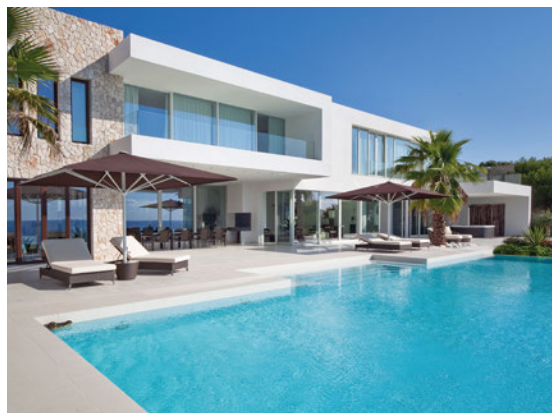



PIETRA SERENA

Pietra Serena Ivory Natural 29,75x59,55 cm







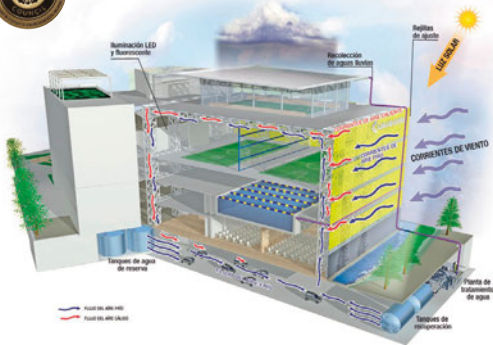







EL CUBO BUSINESS & RECREATIVE CENTER  
Bogotá. (COLOMBIA)  
Arch. EDGAR SOLANO



1er EDIFICIO con **CERTIFICACIÓN LEED** categoría **ORO** en COLOMBIA.



# TECHNICAL CHARACTERISTICS. CARATTERISTICHE TECNICHE. CARACTERÍSTICAS TÉCNICAS

MEASUREMENTS AND SURFACES APPEARANCE / DIMENSIONI E ASPETTO SUPERFICIALE / MEDIDAS Y ASPECTO SUPERFICIAL / MASSEN UND AUSSEHEN DER OBERFLÄCHE		STANDARD TEST METHOD METODO DELLA NORMA METODO DE ENSAYO STANDARD TEST METHOD	STANDARD PRESCRIBED VALUES VALORE PRESCRITTO VALORES STANDARD NORMA STANDARDWERTE	PIETRA SERENA collection *
 Length and width. <i>Lunghezza e larghezza.</i> Longitud y anchura. Länge und Breite		ISO 10545-2	± 0,6% max.	± 0,1% *
 Thickness. <i>Spessore.</i> Grosor. Stärke		ISO 10545-2	± 5% max.	± 2% *
 90° Orthogonality. <i>Ortogonalità.</i> Ortogonalidad. Rechtwinkligkeit		ISO 10545-2	± 0,6% max.	± 0,2%
 Straightness of sides. <i>Rettilinearità dei lati.</i> Rectitud de lados. Kantengeradigkeit		ISO 10545-2	± 0,5% max.	± 0,2%
 Surfaces flatness. <i>Planarità.</i> Planitud. Ebenflächigkeit		ISO 10545-2	± 0,5% max.	± 0,2%
PHYSICAL PROPERTIES / PROPIETÀ FISICHE / PROPIEADADES FÍSICAS / PHYSIKALISCHE EIGENSCHAFTEN				
 Water absorption. <i>Assorbimento d' acqua.</i> Absorción de agua. Wasseraufnahme		ISO 10545-3	≤ 0,5%	≤ 0,1%
 Breaking strength, in N. <i>Carico di rottura, en N.</i> Carga de rotura, en N. Bruchlast, in N	thickness > 7,5 mm spessore > 7,5 mm grösor > 7,5 mm	ISO 10545-4	≥ 1300 N	2800 N *
 Modulus of rupture. <i>Resistenza alla flessione.</i> Resistencia a la flexión. Biegefestigkeit		ISO 10545-4	≥ 35 N/mm <sup>2</sup>	52 N/mm <sup>2</sup> *
 Resistance to deep abrasion. <i>Resistenza all' abrasione profonda.</i> Resistencia a la abrasión profunda. Tiefverschleissbeständigkeit		ISO 10545-6	≤ 175 mm <sup>3</sup>	110 mm <sup>3</sup> *
 Resistance to thermal shock. <i>Resistenza agli sbalzi termici.</i> Resistencia al choque térmico. Temperaturwechselbeständigkeit		ISO 10545-9	No surface defects should be visible Non deve presentare difetti visibili No debe presentar defectos superficiales visibles	Resistant. Resistente. Resistente
 Frost resistance. <i>Resistenza al gelo.</i> Resistencia a la helada. Frostbeständigkeit		ISO 10545-12	No surface defects or cracks should be visible Non deve presentare difetti visibili No debe presentar defectos ni grietas superficiales visibles	Frost Resistant "Antigrassia" Resistente a la Helada
 Coefficient of friction. <i>Resistenza allo scivolamento.</i> Coeficiente de fricción. Rutschfestigkeit		DIN 51130 UNE - ENV 12633 ASTM C 1028-96	WET TEST/ENSAYO EN HÚMEDO DRY TEST/ENSAYO EN SECO S.C.O.F. > 0.60 (for horizontal surfaces)	R9-R11-R12** Clase - Clase 3*** Clase 3**** S.C.O.F. 0.70 - 0.70 - 0.77 ***** DCOF - ANSIA 137.1-2012 > 0.42
 Colour resistance to light. <i>Resistenza dei colori alla luce.</i> Resistencia del color a la luz. Lichtbeständigkeit der Farben		DIN 51094	There should be no colour variations Non deve presentare difetti visibili No debe presentar variaciones de color	No alterations in colour and shine Non presenta alterazioni di colori e lucentezza No presenta variaciones de color y brillo
CHEMICAL PROPERTIES / PROPIETÀ CHIMICHE / PROPIEADADES QUÍMICAS / CHEMISCHEN EIGENSCHAFTEN				
 Chemical resistance. <i>Resistenza agli agenti chimici.</i> Resistencia química. Chemikalienbeständigkeit		ISO 10545-13	Resistance to household cleaning products and swimmingpools salts. Resistencia a productos domésticos y sales para piscinas	Min. UB
 Resistance to staining. <i>Resistenza alle macchie.</i> Resistencia a las manchas. Fleckenbeständigkeit		ISO 10545-14	≥ 3	5 *

\*The Land values are the average of different production consignments. For further detail information, please check with our commercial network. / I valori dichiarati sono ottenuti da una media di prove effettuate su diverse produzioni. Per avere informazioni dettagliate consultare la rete commerciale / Los valores declarados son el promedio obtenido a través de ensayos de diferentes producciones. Para la obtención de una información detallada consultar a la red comercial.

\*\* R9-Tested in natural finish / R11-Tested in rigato and filosega finishes / R12-Tested in bocciardato finishes

\*\*\* Clase 1 - Tested in natural finish (It depends on the consignment) / Clase 3 - Tested in rigato, filosega and bocciardato finishes.  
Test realized in internal laboratory / Provaré realizzato in laboratorio interno / Ensayo realizado en laboratorio interno.

\*\*\*\* Dry Test, according to document DA DB-SUA/3 (Código Técnico de la Edificación) M° de Fomento. Average test result value, on May 2012.  
Ensayo realizado, según documento DA DB-SUA/3 (Código Técnico de la edificación) M° de Fomento, valor medio a fecha Mayo 2012.

\*\*\*\*\* SMITH-EMERY laboratories. SCOF: Static Coefficient of Friction. Tested in natural: 0.70 - Tested in lappato: 0.70 - Tested in bocciardato: 0.77

lappato

natural

filosega

rigato

bocciardato

CLASE 1

CLASE 1  
R9

CLASE 3  
R11

CLASE 3  
R11

CLASE 3  
R12

PIETRA SERENA

# AZULCASCAIS



STONE



ALBORAYA PALMARET - RAILWAY STATION  
Valencia. (SPAIN)  
Arch. Jose Javier Martí. Rstudio

\* Austral ivory natural. Content of recycled material. Contenido de material reciclado.

## FORMATS.FORMATI.FORMATOS

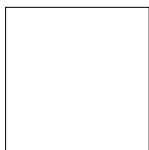

**60X60**  
59,55x59,55 cm  
23.45" x23.45"

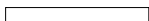

**7,5X60**  
7,3x59,55 cm  
2.87" x23.45"



**30X60**  
29,75x59,55 cm - 11.71"x23.45"

## SPECIAL PIECES.PEZZI SPECIALI.PIEZAS ESPECIALES

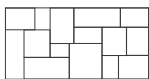

**30X60 artech**  
29,75x59,55 cm - 11.71"x23.45"



**30X30 mosaico 3,5x3,5**  
29,75x29,75 cm - 11.71"x11.71"

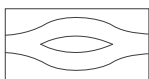

**30X60 eye**  
29,75x59,55 cm - 11.71"x23.45"



**30X30 mosaico 3,5x10**  
29,75x29,75 cm - 11.71"x11.71"



**7,5X60 rodapié**  
7,3x59,55 cm - 2.87"x23.45"



**muretto**  
14,56x29,75 cm  
5.73"x11.71"

## THICKNESS.SPESSORE.ESPESORES

≡ 1,03 cm / 0.40" approx.

## COLOURS COLORI COLORES



**Ivory**

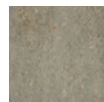

**Moss**



**Graphite**

## FINISHES FINITURI ACABADOS



**Natural**

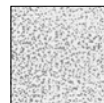

**Lappato**

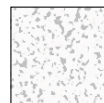

**Estructurado**

# AZULCASCAIS ivory

## PLAIN TILES.BASE.BASES



**Azulcascais ivory natural**  
59,55 x 59,55 cm - 23.45" x 23.45"  
G-6330

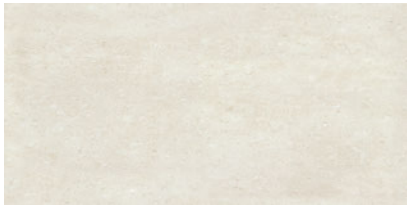

**Azulcascais ivory natural / estructurado**  
29,75 x 59,55 cm - 11.71" x 23.45"  
G-6258 / 6298



**Azulcascais ivory natural / estructurado listelo**  
7,3 x 59,55 cm - 2.87" x 23.45"  
G-5087 / 5091 / 5091

**Azulcascais natural**

**CLASE 1**

UNE - ENV 12633

**R10**

DIN 51130

**Azulcascais estructurado**

**CLASE 3**

UNE - ENV 12633

## SPECIAL PIECES.PEZZI SPECIALI.PIEZAS ESPECIALES

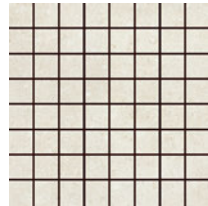

**Azulcascais ivory natural mosaico 3,5x3,5**  
29,75 x 29,75 cm - 11.71" x 11.71"  
G-6756

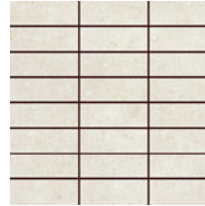

**Azulcascais ivory natural mosaico 3,5x10**  
29,75 x 29,75 cm - 11.71" x 11.71"  
G-6748



**Azulcascais ivory natural rodapié 60**  
7,3 x 59,55 cm - 2.87" x 23.45"  
G-5097



**Azulcascais ivory natural muretto**  
14,56 x 29,75 cm - 5.73" x 11.71"  
G-5131

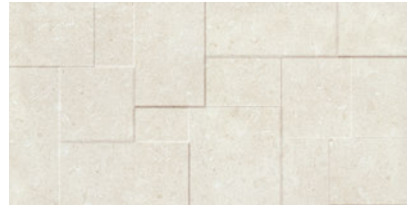

**Azulcascais ivory artech**  
29,75 x 59,55 cm - 11.71" x 23.45"  
G-6298

## STEPS.GRADINI.PELDAÑOS

		natural	lappato	estructurado
SIMPLE	peldaño simple-30 (30x60 cm)	5171	-	5195
	peldaño simple-60 (30x60 cm)	5171	-	5195
	peldaño simple áng. (30x60 cm)	5187	-	5211
	peldaño simple (60x60 cm)	5281	5281	-
	peldaño simple áng. (60x60 cm)	5299	5299	-
GRADONE	peldaño grad-30 (30x60 cm)	5559	-	5559
	peldaño grad-60 (30x60 cm)	5559	-	5559
	peldaño grad. áng (30x60 cm)	5609	-	5609
	peldaño grad-60 (60x60 cm)	5559	5559	-
	peldaño grad. áng (60x60 cm)	5609	5609	-

+ INFO pag. 207.

## COMPLEMENTS.COMPLEMENTI.COMPLEMENTOS

**Byte white / moss / red / black lista 60\***  
1,5 x 59,55 cm - 0.59" x 23.45"  
G-5100

**Fusion natural lista 60\***  
1 x 59,55 cm - 0.39" x 23.45"  
G-5049

**Fusion graffiato lista 60**  
1,5 x 59,55 cm - 0.59" x 23.45"  
G-5069

\* recommended only for walls

## PLAIN TILES.BASE.BASES



**Azulcascais moss natural / lappato**  
59,55 x 59,55 cm - 23.45" x 23.45"  
G-6330 / 6372

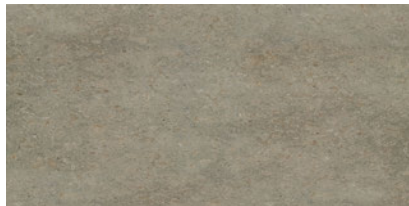

**Azulcascais moss natural / estructurado**  
29,75 x 59,55 cm - 11.71" x 23.45"  
G-6258 / 6298



**Azulcascais moss natural / lappato / estructurado listelo**  
7,3 x 59,55 cm - 2.87" x 23.45"  
G-5087 / 5091 / 5091

**Azulcascais natural**

**CLASE 1**  
UNE - ENV 12633

**R10**  
DIN 51130

**Azulcascais estructurado**

**CLASE 3**  
UNE - ENV 12633

## SPECIAL PIECES.PEZZI SPECIALI.PIEZAS ESPECIALES

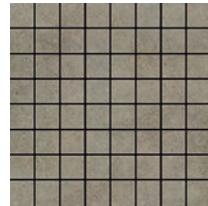

**Azulcascais moss natural mosaico 3,5x3,5**  
29,75 x 29,75 cm - 11.71" x 11.71"  
G-6756



**Azulcascais moss natural mosaico 3,5x10**  
29,75 x 29,75 cm - 11.71" x 11.71"  
G-6748

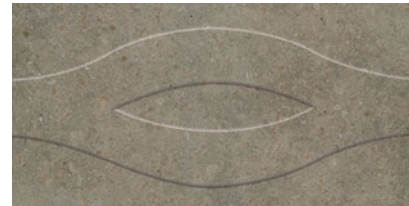
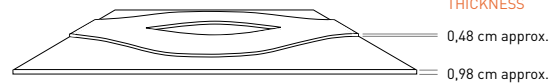

**Azulcascais moss eye**  
29,75 x 59,55 cm - 11.71" x 23.45"  
G-5311

## STEPS.GRADINI.PELDAÑOS

		natural	lappato	estructurado	
SIMPLE		peldaño simple-30 (30x60 cm)	5171	-	5195
		peldaño simple-60 (30x60 cm)	5171	-	5195
		peldaño simple áng. (30x60 cm)	5187	-	5211
		peldaño simple (60x60 cm)	5281	-	-
		peldaño simple áng. (60x60 cm)	5299	5299	-
GRADONE		peldaño grad-30 (30x60 cm)	5559	-	5559
		peldaño grad-60 (30x60 cm)	5559	-	5559
		peldaño grad. áng. (30x60 cm)	5609	-	5609
		peldaño grad-60 (60x60 cm)	5559	5559	-
		peldaño grad. áng. (60x60 cm)	5609	5609	-

+ INFO pag. 207.



**Azulcascais moss natural rodapié 60**  
7,3 x 59,55 cm - 2.87" x 23.45"  
G-5097



**Azulcascais moss natural muretto**  
14,56 x 29,75 cm - 5.73" x 11.71"  
G-5131



**Azulcascais moss artech \***  
29,75 x 59,55 cm - 11.71" x 23.45"  
G-6298

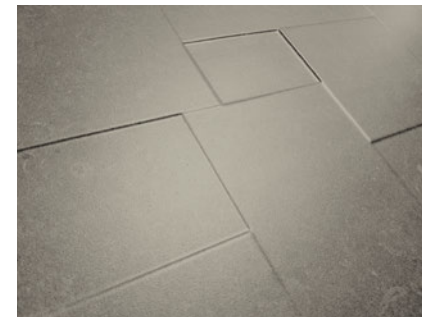

\* Azulcascais moss artech

# AZULCASCAIS graphite

## PLAIN TILES.BASE.BASES



**Azulcascais graphite lappato**  
59,55 x 59,55 cm - 23.45" x 23.45"  
G-6330 / 6372

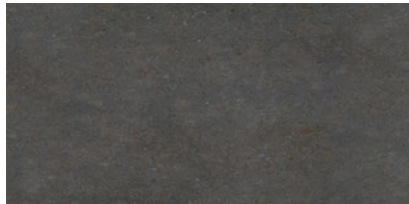

**Azulcascais graphite natural / estructurado**  
29,75 x 59,55 cm - 11.71" x 23.45"  
G-6258 / 6298



**Azulcascais graphite natural / lappato / estructurado listelo**  
7,3 x 59,55 cm - 2.87" x 23.45"  
G-5087 / 5091 / 5091

**Azulcascais natural**

**CLASE 1**

**R10**

UNE - ENV 12633 DIN 51130

**Azulcascais estructurado**

**CLASE 3**

UNE - ENV 12633

## SPECIAL PIECES.PEZZI SPECIALI.PIEZAS ESPECIALES

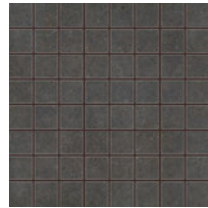

**Azulcascais graphite natural mosaico 3,5x3,5**  
29,75 x 29,75 cm - 11.71" x 11.71"  
G-6756



**Azulcascais graphite natural mosaico 3,5x10**  
29,75 x 29,75 cm - 11.71" x 11.71"  
G-6748

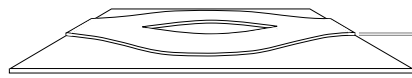

THICKNESS  
0,48 cm approx.  
0,98 cm approx.



**Azulcascais graphite eye**  
29,75 x 59,55 cm - 11.71" x 23.45"  
G-5311

## STEPS.GRADINI.PELDAÑOS

		natural	lappato	estructurado
SIMPLE	peldaño simple-30 (30x60 cm)	5171	-	5195
	peldaño simple-60 (30x60 cm)	5171	-	5195
	peldaño simple áng. (30x60 cm)	5187	-	5211
	peldaño simple (60x60 cm)	5281	5281	-
	peldaño simple áng. (60x60 cm)	5299	5299	-
GRADONE	peldaño grad-30 (30x60 cm)	5559	-	5559
	peldaño grad-60 (30x60 cm)	5559	-	5559
	peldaño grad. áng. (30x60 cm)	5609	-	5609
	peldaño grad-60 (60x60 cm)	5559	5559	-
	peldaño grad. áng. (60x60 cm)	5609	5609	-

+ INFO pag. 207.



**Azulcascais graphite natural rodapié 60**  
7,3 x 59,55 cm - 2.87" x 23.45"  
G-5097



**Azulcascais graphite natural muretto**  
14,56 x 29,75 cm - 5.73" x 11.71"  
G-5131

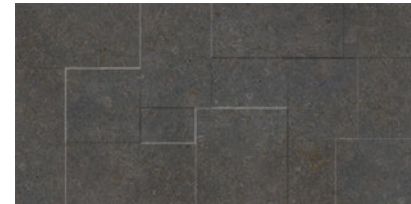

**Azulcascais graphite artech**  
29,75 x 59,55 cm - 11.71" x 23.45"  
G-6298

## COMPLEMENTS.COMPLEMENTI.COMPLEMENTOS



**Byte white / moss / red / black lista 60\***  
1,5 x 59,55 cm - 0.59" x 23.45"  
G-5100

**Fusion natural lista 60\***  
1 x 59,55 cm - 0.39" x 23.45"  
G-5049

**Fusion graffiato lista 60**  
1,5 x 59,55 cm - 0.59" x 23.45"  
G-5069

\* recommended only for walls

















Azulcascais Moss Natural 60x60 cm

ALBORAYA PALMARET RAILWAY STATION  
Valencia. (SPAIN)  
Arch. Jose Javier MARTÍ. Rstudio

AZULCASCAIS



# TECHNICAL CHARACTERISTICS. CARATTERISTICHE TECNICHE. CARACTERÍSTICAS TÉCNICAS

MEASUREMENTS AND SURFACES APPEARANCE / DIMENSIONI E ASPETTO SUPERFICIALE / MEDIDAS Y ASPECTO SUPERFICIAL / MASSEN UND AUSSEHEN DER OBERFLÄCHE		STANDARD TEST METHOD METODO DELLA NORMA METODO DE ENSAYO STANDARD TEST METHOD	STANDARD PRESCRIBED VALUES VALORE PRESCRITTO VALORES STANDARD NORMA STANDARDWERTE	AZULCASCAIS collection *
 Length and width. <i>Lunghezza e larghezza.</i> Longitud y anchura. Länge und Breite		ISO 10545-2	± 0,6% max.	± 0,1%
 Thickness. <i>Spessore.</i> Grosor. Stärke		ISO 10545-2	± 5% max.	± 2%
 90° Orthogonality. <i>Ortogonalità.</i> Ortogonalidad. Rechtwinkligkeit		ISO 10545-2	± 0,6% max.	± 0,2%
 Straightness of sides. <i>Rettilinearità dei lati.</i> Rectitud de lados. Kantengeradigkeit		ISO 10545-2	± 0,5% max.	± 0,2%
 Surfaces flatness. <i>Planarità.</i> Planitud. Ebenföchigkeit		ISO 10545-2	± 0,5% max.	± 0,2%
PHYSICAL PROPERTIES / PROPIETÀ FISICHE / PROPIEDADES FÍSICAS / PHYSIKALISCHE EIGENSCHAFTEN				
 Water absorption. <i>Assorbimento d' acqua.</i> Absorción de agua. Wasseraufnahme		ISO 10545-3	≤ 0,5%	≤ 0,1%
 Breaking strength, in N. <i>Carico di rottura, en N.</i> Carga de rotura, en N. Bruchlast, in N	thickness > 7,5 mm spessore > 7,5 mm grosor > 7,5 mm	ISO 10545-4	≥ 1300 N	2400 N *
 Modulus of rupture. <i>Resistenza alla flessione.</i> Resistencia a la flexión. Biegefestigkeit		ISO 10545-4	≥ 35 N/mm <sup>2</sup>	56 N/mm <sup>2</sup> *
 Resistance to deep abrasion. <i>Resistenza all' abrasione profonda.</i> Resistencia a la abrasión profunda. Tiefverschleissbeständigkeit		ISO 10545-6	≤ 175 mm <sup>3</sup>	115 mm <sup>3</sup> *
 Resistance to thermal shock. <i>Resistenza agli sbalzi termici.</i> Resistencia al choque térmico. Temperaturwechselbeständigkeit		ISO 10545-9	No surface defects should be visible <i>Non deve presentare difetti visibili</i> No debe presentar defectos superficiales visibles	Resistant. <i>Resistente. Resistente</i>
 Resistance to frost. <i>Resistenza al gelo.</i> Resistencia a la helada. Frostbeständigkeit		ISO 10545-12	No surface defects or cracks should be visible <i>Non deve presentare difetti visibili</i> No debe presentar defectos ni grietas superficiales visibles	Frost Resistant <i>Antigranizo</i> Resistente a la Helada
 Coefficient of friction. <i>Resistenza allo scivolamento.</i> Coeficiente de fricción. Rutschfestigkeit		DIN 51130 UNE - ENV 12633	WET TEST/ENSAYO EN HÚMEDO DRY TEST/ENSAYO EN SECO	R10** Clase 1 *** - Clase 3 *** Clase 3 ****
 Colour resistance to light. <i>Resistenza dei colori alla luce.</i> Resistencia del color a la luz. Lichtbeständigkeit der Farben		DIN 51094	There should be no colour variations <i>Non deve presentare difetti visibili</i> No debe presentar variaciones de color	No alterations to colour and shine <i>Non deve presentare alterazioni di colori e lucentezza</i> No debe presentar variaciones de color y brillo
CHEMICAL PROPERTIES / PROPIETÀ CHIMICHE / PROPIEDADES QUÍMICAS / CHEMISCHEN EIGENSCHAFTEN				
 Chemical resistance. <i>Resistenza agli agenti chimici.</i> Resistencia química. Chemikalienbeständigkeit		ISO 10545-13	Resistance to household cleaning products and swimmingpools salts. <i>Resistencia a productos domesticos y sales para piscinas</i>	Min. UB
 Resistance to staining. <i>Resistenza alle macchie.</i> Resistencia a las manchas. Fleckenbeständigkeit		ISO 10545-14	≥ 3	5

\*The Land values are the average of different production consignments. For further detail information, please check with our commercial network. / I valori dichiarati sono ottenuti da una media di prove effettuate su diverse produzioni. Per avere informazioni dettagliate consultare la rete commerciale. / Los valores declarados son el promedio obtenido a través de ensayos de diferentes producciones. Para la obtención de una información detallada consultar a la red comercial.

\*\* R10 - Tested in Azulcascais Moss Natural (batch: 13-04-2010). It depends on the consignment. / Provare realizzato in Azulcascais Moss Natural (partita: 13-04-2010). / Ensayo realizado sobre Azulcascais Moss Natural (lote: 13-04-2010).

\*\*\* Clase 1 - Tested in natural finish (It depends on the consignment) / Clase 3 - Tested in estructurado finish. Test realized in internal laboratory / Provare realizzato in laboratorio interno / Ensayo realizado en laboratorio interno.

\*\*\*\* Dry Test, according to document DA DB-SUA/3 (Código Técnico de la Edificación) M° de Fomento. Average test result value, on May 2012. Ensayo realizado, según documento DA DB-SUA/3 (Código Técnico de la edificación) M° de Fomento, valor medio a fecha Mayo 2012.



AZULCASCAIS

Azulcascais Graphite - Ivory Natural 59,55x59,55 cm

# CELTIC



STONE

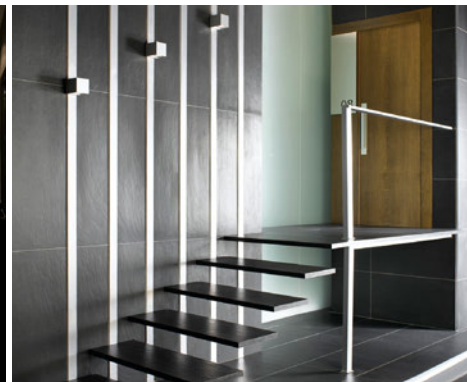

SHOWROOM - OFFICES IMPORT ARRASATE  
Mondragón, País Vasco. (SPAIN)

\* Celtic black. Content of recycled material. Contenido de material reciclado.

## FORMATS.FORMATI.FORMATOS



**45X90**  
44,63x89,46 cm - 17.57"x35.22"



**22,5X90**  
22,21x89,46 cm - 8.75"x35.22"



**15X90**  
14,7x89,46 cm - 5.78"x35.22"



**7,5X90**  
7,3x89,46 cm - 2.87"x35.22"

## SPECIAL PIECES.PEZZI SPECIALI.PIEZAS ESPECIALES

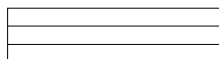

**22,5X90 preincisión 7,5x90**  
22,21x89,46 cm - 8.75"x35.22"



**7,5X45 rodapié**  
7,3x44,63 cm - 2.87"x17.57"



**30X30 mosaico 5x5**  
29,75x29,75 cm - 11.71"x11.71"



**30X30 mosaico 5x10**  
29,75x29,75 cm - 11.71"x11.71"



**muretto**  
14,56x29,75 cm  
5.73"x11.71"

## THICKNESS.SPESSORE.ESPESORES

 1,11 cm / 0.44" approx.

## COLOURS COLORI COLORES

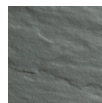

**Olive**

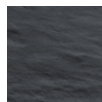

**Black**

## FINISHES FINITURI ACABADOS

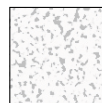

**Estructurado**

## PLAIN TILES.BASE.BASES

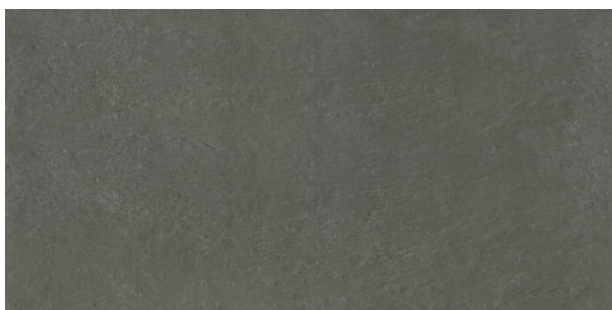

### Celtic olive

44,63 x 89,46 cm - 17.57" x 35.22"  
G-6410

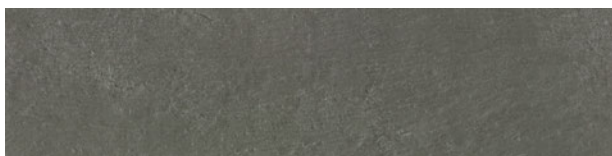

### Celtic olive

22,21 x 89,46 cm - 8.75" x 35.22"  
G-6456



### Celtic olive cenefa-3

14,7 x 89,46 cm - 5.78" x 35.22"  
G-5155



### Celtic olive listelo 90

7,3 x 89,46 cm - 2.87" x 35.22"  
G-5119

This collection imitates the natural structure of the slate.  
Questa collezione imita la struttura naturale dell'ardesia.  
Esta colección imita la estructura natural de la pizarra.

Celtic natural

**CLASE 1**

UNE - ENV 12633

## SPECIAL PIECES.PEZZI SPECIALI.PIEZAS ESPECIALES

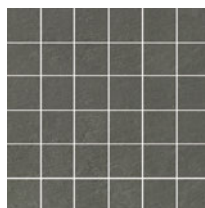

### Celtic olive mosaico 5x5

29,75 x 29,75 cm - 11.71" x 11.71"  
G-6688



### Celtic olive mosaico 5x10

29,75 x 29,75 cm - 11.71" x 11.71"  
G-6688



### Celtic olive muretto

14,56 x 29,75 cm - 5.73" x 11.71"  
G-6768



### Celtic olive preincisión 7,5x90

22,21 x 89,46 cm - 8.75" x 35.22"  
G-6558



### Celtic olive rodapié 45

7,3 x 44,63 cm - 2.87" x 17.57"  
G-5087

## STEPS.GRADINI.PELDAÑOS

SIMPLE		peldaño-90	(45x90 cm)	5333
		peldaño áng.	(45x90 cm)	5345
GRADONE		peldaño grad áng.	(45x90 cm)	5645
		peldaño grad-90	(45x90 cm)	5623

+ INFO pag. 207

## COMPLEMENTS.COMPLEMENTI.COMPLEMENTOS



### Byte white / ice / yellow / orange / red / purple / blue / grey / moss / black lista 90\*

2 x 89,46 cm - 0.79" x 35.22"



G-5173

### Fusion graffiato lista 90

1,5 x 89,46 cm - 0.59" x 35.22"



G-5091

### Byte ice / yellow / red / black lista 60\*

1,5 x 59,55 cm - 0.59" x 23.45"



G-5100

### Fusion natural lista 60\*

1 x 59,55 cm - 0.39" x 23.45"



G-5049

### Fusion graffiato lista 60

1,5 x 59,55 cm - 0.59" x 23.45"



G-5069

\* recommended only for walls



CELTIC

# CELTIC black

## PLAIN TILES.BASE.BASES

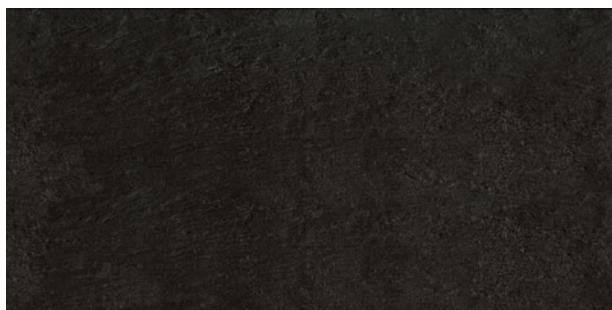

**Celtic black**  
44,63 x 89,46 cm - 17.57" x 35.22"  
G-6372

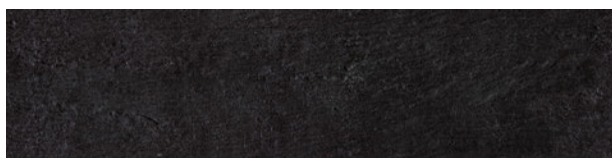

**Celtic black**  
22,21 x 89,46 cm - 8.75" x 35.22"  
G-6426



**Celtic black cenefa-3**  
14,7 x 89,46 cm - 5.78" x 35.22"  
G-5155



**Celtic black listelo 90**  
7,3 x 89,46 cm - 2.87" x 35.22"  
G-5119

This collection imitates the natural structure of the slate.  
Questa collezione imita la struttura naturale dell'ardesia.  
Esta colección imita la estructura natural de la pizarra.

Celtic natural

**CLASE 1**

UNE - ENV 12633

## SPECIAL PIECES.PEZZI SPECIALI.PIEZAS ESPECIALES

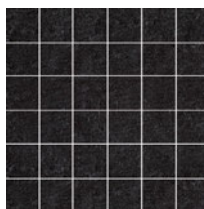

**Celtic black mosaico 5x5**  
29,75 x 29,75 cm - 11.71" x 11.71"  
G-6688

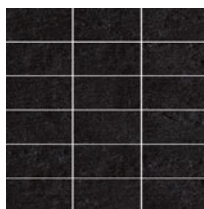

**Celtic black mosaico 5x10**  
29,75 x 29,75 cm - 11.71" x 11.71"  
G-6688



**Celtic black muretto**  
14,56 x 29,75 cm - 5.73" x 11.71"  
G-6768



**Celtic black preincisión 7,5x90**  
22,21 x 89,46 cm - 8.75" x 35.22"  
G-6558



**Celtic black rodapié 45**  
7,3 x 44,63 cm - 2.87" x 17.57"  
G-5087

## STEPS.GRADINI.PELDAÑOS

SIMPLE		peldaño-90 (45x90 cm) 5323
		peldaño áng. (45x90 cm) 5333
GRADONE		peldaño grad áng. (45x90 cm) 5645
		peldaño grad-90 (45x90 cm) 5623

+ INFO pag. 207.

## COMPLEMENTS.COMPLEMENTI.COMPLEMENTOS



**Byte white / ice / yellow / orange / red / purple / blue / grey / moss / black lista 90\***

2 x 89,46 cm - 0.79" x 35.22"



G-5173

**Fusion graffiato lista 90**

1,5 x 89,46 cm - 0.59" x 35.22"



G-5091

**Byte ice / yellow / red / black lista 60\***

1,5 x 59,55 cm - 0.59" x 23.45"



G-5100

**Fusion natural lista 60\***

1 x 59,55 cm - 0.39" x 23.45"



G-5049

**Fusion graffiato lista 60**

1,5 x 59,55 cm - 0.59" x 23.45"



G-5069

\* recommended only for walls

















CELTIC

Celtic Black - 44,63x89,46 cm

BUSINESS & RECREATIVE CENTER EL CUBO  
BOGOTÁ. (COLOMBIA)  
ARCH: EDGAR SOLANO

# TECHNICAL CHARACTERISTICS. CARATTERISTICHE TECNICHE. CARACTERÍSTICAS TÉCNICAS

MEASUREMENTS AND SURFACES APPEARANCE / DIMENSIONI E ASPETTO SUPERFICIALE / MEDIDAS Y ASPECTO SUPERFICIAL / MASSEN UND AUSSEHEN DER OBERFLÄCHE		STANDARD TEST METHOD METODO DELLA NORMA METODO DE ENSAYO STANDARD TEST METHOD	STANDARD PRESCRIBED VALUES VALORE PRESCRITTO VALORES STANDARD NORMA STANDARDWERTE	CELTIC collection *
 <b>Length and width.</b> <i>Lunghezza e larghezza.</i> Longitud y anchura. Länge und Breite		ISO 10545-2	± 0,6% max.	± 0,1%
 <b>Thickness.</b> <i>Spessore.</i> Grosor. Stärke		ISO 10545-2	± 5% max.	± 2%
 <b>90° Orthogonality.</b> <i>Ortogonalità.</i> Ortogonalidad. Rechtwinkligkeit		ISO 10545-2	± 0,6% max.	± 0,2%
 <b>Straightness of sides.</b> <i>Rettilinearità dei lati.</i> Rectitud de lados. Kantengeradigkeit		ISO 10545-2	± 0,5% max.	± 0,2%
 <b>Surfaces flatness.</b> <i>Planarità.</i> Planitud. Ebenföchigkeit		ISO 10545-2	± 0,5% max.	± 0,2%
PHYSICAL PROPERTIES / PROPIETÀ FISICHE / PROPIEADADES FÍSICAS / PHYSIKALISCHE EIGENSCHAFTEN				
 <b>Water absorption.</b> <i>Assorbimento d'acqua.</i> Absorción de agua. Wasseraufnahme		ISO 10545-3	≤ 0,5%	≤ 0,1%
 <b>Breaking strength, in N.</b> <i>Carico di rottura, en N.</i> Carga de rotura, en N. Bruchlast, in N	thickness > 7,5 mm spessore > 7,5 mm grosor > 7,5 mm	ISO 10545-4	≥ 1300 N	2400 N *
 <b>Modulus of rupture.</b> <i>Resistenza alla flessione.</i> Resistencia a la flexión. Biegefestigkeit		ISO 10545-4	≥ 35 N/mm <sup>2</sup>	56 N/mm <sup>2</sup> *
 <b>Resistance to deep abrasion.</b> <i>Resistenza all'abrasione profonda.</i> Resistencia a la abrasión profunda. Tiefverschleissbeständigkeit		ISO 10545-6	≤ 175 mm <sup>3</sup>	106 mm <sup>3</sup> *
 <b>Resistance to thermal shock.</b> <i>Resistenza agli sbalzi termici.</i> Resistencia al choque térmico. Temperaturwechselbeständigkeit		ISO 10545-9	No surface defects should be visible Non deve presentare difetti visibili No debe presentar defectos superficiales visibles	Resistant. Resistente. Resistente
 <b>Frost resistance.</b> <i>Resistenza al gelo.</i> Resistencia a la helada. Frostbeständigkeit		ISO 10545-12	No surface defects or cracks should be visible Non deve presentare difetti visibili No debe presentar defectos ni grietas superficiales visibles	Frost Resistant Antighiaccio Resistente a la Helada
 <b>Non-slip.</b> <i>Resistenza allo scivolamento.</i> Capacidad antideslizamiento. Rutschfestigkeit		UNE - ENV 12633	WET TEST/ENSAYO EN HÚMEDO DRY TEST/ENSAYO EN SECO	Clase I ** Clase 3 ***
 <b>Colour resistance to light.</b> <i>Resistenza dei colori alla luce.</i> Resistencia del color a la luz. Lichtbeständigkeit der Farben		DIN 51094	There should be no colour variations Non deve presentare difetti visibili No debe presentar variaciones de color	No alterations to colour and shine Non presenta alterazioni di colori e lucentezza No presenta variaciones de color y brillo
CHEMICAL PROPERTIES / PROPIETÀ CHIMICHE / PROPIEADADES QUÍMICAS / CHEMISCHEN EIGENSCHAFTEN				
 <b>Chemical resistance.</b> <i>Resistenza agli agenti chimici.</i> Resistencia química. Chemikalienbeständigkeit		ISO 10545-13	Resistance to household cleaning products and swimmingpools salts. Resistencia a productos domésticos y sales para piscinas	Min. UB
 <b>Resistance to staining.</b> <i>Resistenza alle macchie.</i> Resistencia a las manchas. Fleckenbeständigkeit		ISO 10545-14	≥ 3	5

\*The Land values are the average of different production consignments. For further detail information, please check with our commercial network. /  
I valori dichiarati sono ottenuti da una media di prove effettuate su diverse produzioni. Per avere informazioni dettagliate consultare la rete commerciale /  
Los valores declarados son el promedio obtenido a través de ensayos de diferentes producciones. Para la obtención de una información detallada consultar a la red comercial.

\*\*Test realized in internal laboratory. Provare realizzato in laboratorio interno. Ensayo realizado en laboratorio interno.

\*\*\*Dry Test, according to document DA DB-SUA/3 (Código Técnico de la Edificación) M° de Fomento. Average test result value, on May 2012.  
Ensayo realizado, según documento DA DB-SUA/3 (Código Técnico de la edificación) M° de Fomento, valor medio a fecha Mayo 2012.



Celtic Black - 44,63x89,46 cm

COFFEE MALACCA DEL MAR  
Sevilla. (SPAIN)

CELTIC

# AUSTRAL



STONE



SHOPPING CENTER EL ZIELO  
Madrid. (SPAIN)  
Arch. Raquel Fernández Maudez

\* Austral copper estructurado. Content of recycled material. Contenido de material reciclado.

## FORMATS.FORMATI.FORMATOS



**45X90**  
44,63x89,46 cm - 17.57"x35.22"



**30X60**  
29,75x59,55 cm - 11.71"x23.45"



**22,5X90**  
22,21x89,46 cm - 8.75"x35.22"



**7,5X90**  
7,3x89,46 cm - 2.87"x35.22"



**7,5X60**  
7,3x59,55 cm - 2.87"x23.45"

## SPECIAL PIECES.PEZZI SPECIALI.PIEZAS ESPECIALES

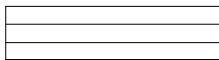

**22,5X90 preincisión 7,5x90**  
22,21x89,46 cm - 8.75"x35.22"



**30X30 mosaico 3,5x3,5**  
29,75x29,75 cm - 11.71"x11.71"

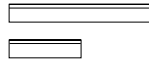

**7,5X60 rodapié**  
**7,5X30 rodapié**  
7,3x59,55 cm - 2.87"x23.45"  
7,3x29,75 cm - 2.87"x11.71"

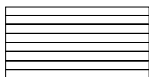

**30X60 preincisión 3,5x60**  
29,75x59,55 cm - 11.71"x23.45"



**30X30 mosaico 3,5x15**  
29,75x29,75 cm - 11.71"x11.71"



**muretto**  
14,56x29,75 cm  
5.73"x11.71"

## THICKNESS.SPESSORE.ESPESORES

- ≡ 1,11 cm / 0.44" approx.
- ≡ 1,03 cm / 0.40" approx.

45x90 cm / 22,5x90 cm FORMATS  
30x60 cm FORMAT

## COLOURS COLORI COLORES

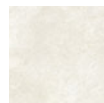

**Ivory**

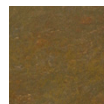

**Copper**

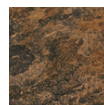

**Antracita**

## FINISHES FINITURI ACABADOS

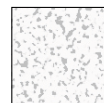

**Estructurado**

## PLAIN TILES.BASE.BASES



**Austral ivory estructurado**  
44,63 x 89,46 cm - 17.57" x 35.22"  
G-6372

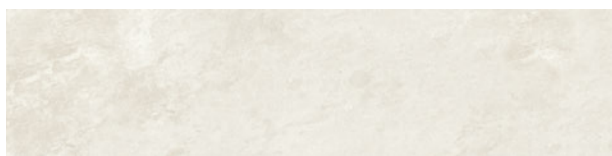

**Austral ivory estructurado**  
22,21 x 89,46 cm - 8.75" x 35.22"  
G-6426



**Austral ivory estructurado listelo 90**  
7,3 x 89,46 cm - 2.87" x 35.22"  
G-5119

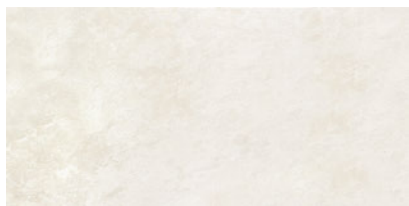

**Austral ivory estructurado**  
29,75 x 59,55 cm - 11.71" x 23.45"  
G-6258



**Austral ivory estructurado listelo 60**  
7,3 x 59,55 cm - 2.87" x 23.45"  
G-5091

These destonified pieces recreate the appearance of a slate.  
*I pezzi ricreano con la loro stonizzazione la vera ardesia.*  
Las piezas recrean con su destonificación y relieve el realismo de la pizarra.

## SPECIAL PIECES.PEZZI SPECIALI.PIEZAS ESPECIALES



**Austral ivory estructurado mosaico 3,5x3,5**  
29,75 x 29,75 cm - 11.71" x 11.71"  
G-6756

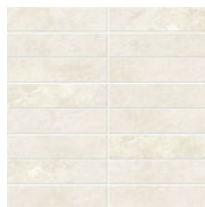

**Austral ivory estructurado mosaico 3,5x15**  
29,75 x 29,75 cm - 11.71" x 11.71"  
G-6708



**Austral ivory estructurado muretto**  
14,56 x 29,75 cm - 5.73" x 11.71"  
G-6768

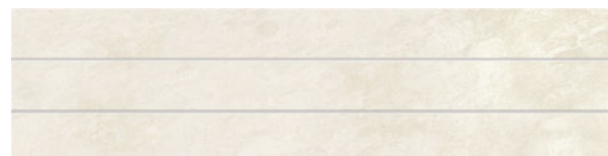

**Austral ivory estructurado precisión 7,5x90**  
22,21 x 89,46 cm - 8.75" x 35.22"  
G-6558



**Austral ivory estructurado precisión 3,5x60**  
29,75 x 59,55 cm - 11.71" x 23.45"  
G-6486



**Austral ivory estructurado rodapié 30**  
7,3 x 29,75 cm - 2.87" x 11.71"  
G-5075



**Austral ivory estructurado rodapié 60**  
7,3 x 59,55 cm - 2.87" x 23.45"  
G-5097

## STEPS.GRADINI.PELDAÑOS

SIMPLE		peldaño simple-30 (30x60 cm)	5171
		peldaño simple-60 (30x60 cm)	5171
		peldaño simple áng (30x60 cm)	5187
		peldaño simple-90 (45x90 cm)	5323
		peldaño simple áng (45x90 cm)	5333
GRADONE		peldaño grad-30 (30x60 cm)	5559
		peldaño grad-60 (30x60 cm)	5559
		peldaño grad. áng (30x60 cm)	5609
		peldaño grad-90 (45x90 cm)	5623
		peldaño grad. áng (45x90 cm)	5645

\* INFO pag. 207.

Austral natural

**CLASE 1**

UNE - ENV 12633



Austral Ivory Estructurado - 29,75x59,55 cm



AUSTRAL

PRIVATE HOUSE. Ventilated Façade  
Ourense. (SPAIN)  
Int. Design. Interior Designer CSR

# AUSTRAL copper

## PLAIN TILES.BASE.BASES

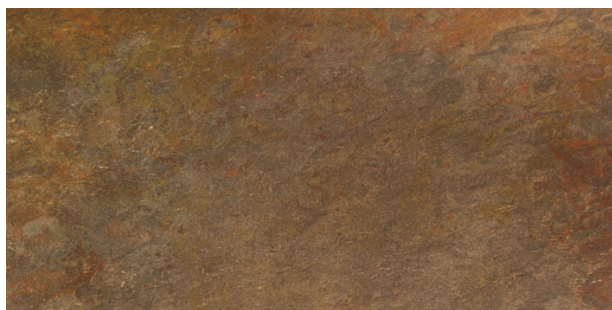

**Austral copper estructurado**  
44,63 x 89,46 cm - 17.57" x 35.22"  
G-6372

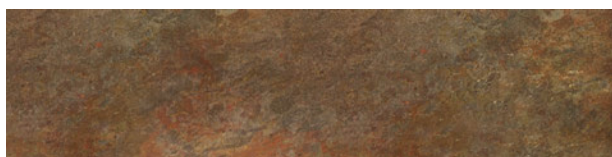

**Austral copper estructurado**  
22,21 x 89,46 cm - 8.75" x 35.22"  
G-6426



**Austral copper estructurado listelo 90**  
7,3 x 89,46 cm - 2.87" x 35.22"  
G-5119



**Austral copper estructurado**  
29,75 x 59,55 cm - 11.71" x 23.45"  
G-6258

## SPECIAL PIECES. PEZZI SPECIALI.PIEZAS ESPECIALES

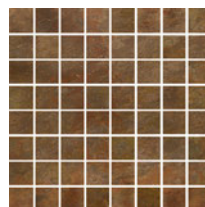

**Austral copper estructurado  
mosaico 3,5x3,5**  
29,75 x 29,75 cm - 11.71" x 11.71"  
G-6756



**Austral copper estructurado  
mosaico 3,5x15**  
29,75 x 29,75 cm - 11.71" x 11.71"  
G-6708



**Austral copper estructurado  
muretto**  
14,56 x 29,75 cm - 5.73" x 11.71"  
G-6768

These destonified pieces recreate the appearance of a slate.  
I pezzi ricreano con la loro stonalizzazio-  
ne la vera ardesia.  
Las piezas recrean con su destonificación  
y relieve el realismo de la pizarra.

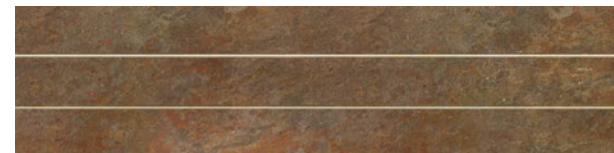

**Austral copper estructurado preincisión 7,5x90**  
22,21 x 89,46 cm - 8.75" x 35.22"  
G-6558



PRIVATE HOUSE  
Moaña, Pontevedra. (SPAIN)  
Arch. Cristina Cordeiro

Austral Copper Estructurado - 44,63x89,46 cm

## PLAIN TILES.BASE.BASES

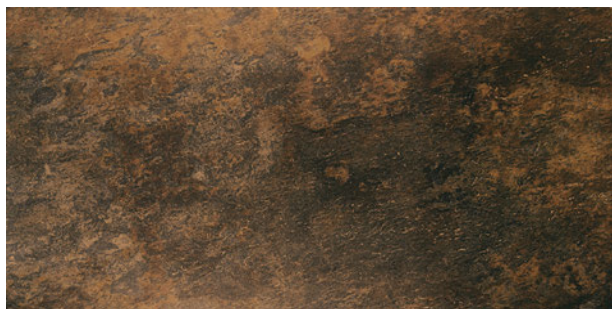

**Austral antracita estructurado**  
44,63 x 89,46 cm - 17.57" x 35.22"  
G-6372

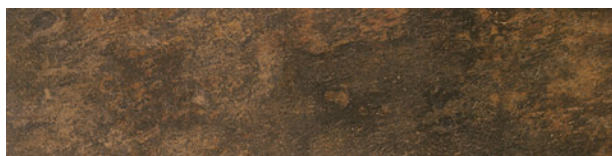

**Austral antracita estructurado**  
22,21 x 89,46 cm - 8.75" x 35.22"  
G-6426



**Austral antracita estructurado listelo 90**  
7,3 x 89,46 cm - 2.87" x 35.22"  
G-5119

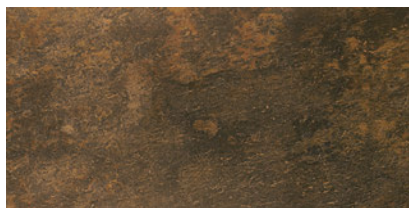

**Austral antracita estructurado**  
29,75 x 59,55 cm - 11.71" x 23.45"  
G-6258



**Austral antracita estructurado listelo 60**  
7,3 x 59,55 cm - 2.87" x 23.45"  
G-5091

These destonified pieces recreate the appearance of a slate.  
I pezzi ricreano con la loro stonizzazione la vera ardesia.  
Las piezas recrean con su destonificación y relieve el realismo de la pizarra.

## SPECIAL PIECES.PEZZI SPECIALI.PIEZAS ESPECIALES



**Austral antracita estructurado mosaico 3,5x3,5**  
29,75 x 29,75 cm - 11.71" x 11.71"  
G-6756



**Austral antracita estructurado mosaico 3,5x15**  
29,75 x 29,75 cm - 11.71" x 11.71"  
G-6708



**Austral antracita estructurado muretto**  
14,56 x 29,75 cm - 5.73" x 11.71"  
G-6768



**Austral antracita estructurado preincisión 7,5x90**  
22,21 x 89,46 cm - 8.75" x 35.22"  
G-6558



**Austral antracita estructurado preincisión 3,5x60**  
29,75 x 59,55 cm - 11.71" x 23.45"  
G-6486



**Austral antracita estructurado rodapié 30**  
7,3 x 29,75 cm - 2.87" x 11.71"  
G-5075

















**Austral antracita estructurado rodapié 60**  
7,3 x 59,55 cm - 2.87" x 23.45"  
G-5097

## STEPS.GRADINI.PELDAÑOS

SIMPLE		peldaño simple-30 (30x60 cm)	5171
		peldaño simple-60 (30x60 cm)	5171
		peldaño simple áng (30x60 cm)	5187
		peldaño simple-90 (45x90 cm)	5323
		peldaño simple áng (45x90 cm)	5333
GRADONE		peldaño grad-30 (30x60 cm)	5559
		peldaño grad-60 (30x60 cm)	5559
		peldaño grad. áng (30x60 cm)	5609
		peldaño grad-90 (45x90 cm)	5623
		peldaño grad. áng (45x90 cm)	5645

+ INFO pag. 207

# TECHNICAL CHARACTERISTICS. CARATTERISTICHE TECNICHE. CARACTERÍSTICAS TÉCNICAS

MEASUREMENTS AND SURFACES APPEARANCE / DIMENSIONI E ASPETTO SUPERFICIALE / MEDIDAS Y ASPECTO SUPERFICIAL / MASSEN UND AUSSEHEN DER OBERFLÄCHE		STANDARD TEST METHOD METODO DELLA NORMA METODO DE ENSAYO STANDARD TEST METHOD	STANDARD PRESCRIBED VALUES VALORE PRESCRITTO VALORES STANDARD NORMA STANDARDWERTE	AUSTRAL collection *
 <b>Length and width.</b> <i>Lunghezza e larghezza.</i> Longitud y anchura. Länge und Breite		ISO 10545-2	± 0,6% max.	± 0,2%
 <b>Thickness.</b> <i>Spessore.</i> Grosor. Stärke		ISO 10545-2	± 5% max.	± 2%
 <b>90° Orthogonality.</b> <i>Ortogonalità.</i> Ortogonalidad. Rechtwinkligkeit		ISO 10545-2	± 0,6% max.	± 0,2%
 <b>Straightness of sides.</b> <i>Rettilinearità dei lati.</i> Rectitud de lados. Kantengeradigkeit		ISO 10545-2	± 0,5% max.	± 0,2%
 <b>Surfaces flatness.</b> <i>Planarità.</i> Planitud. Ebenföchigkeit		ISO 10545-2	± 0,5% max.	± 0,2%
PHYSICAL PROPERTIES / PROPIETÀ FISICHE / PROPIEADADES FÍSICAS / PHYSIKALISCHE EIGENSCHAFTEN				
 <b>Water absorption.</b> <i>Assorbimento d' acqua.</i> Absorción de agua. Wasseraufnahme		ISO 10545-3	≤ 0,5%	≤ 0,1%
 <b>Breaking strength, in N.</b> <i>Carico di rottura, en N.</i> Carga de rotura, en N. Bruchlast, in N	thickness > 7,5 mm spessore > 7,5 mm grosor > 7,5 mm	ISO 10545-4	≥ 1300 N	2400 N *
 <b>Modulus of rupture.</b> <i>Resistenza alla flessione.</i> Resistencia a la flexión. Biegefestigkeit		ISO 10545-4	≥ 35 N/mm <sup>2</sup>	56 N/mm <sup>2</sup> *
 <b>Resistance to deep abrasion.</b> <i>Resistenza all' abrasione profonda.</i> Resistencia a la abrasión profunda. Tiefverschleissbeständigkeit		ISO 10545-6	≤ 175 mm <sup>3</sup>	106 mm <sup>3</sup> *
 <b>Resistance to thermal shock.</b> <i>Resistenza agli sbalzi termici.</i> Resistencia al choque térmico. Temperaturwechselbeständigkeit		ISO 10545-9	No surface defects should be visible Non deve presentare difetti visibili No debe presentar defectos superficiales visibles	Resistant. Resistente. Resistente
 <b>Resistance to frost.</b> <i>Resistenza al gelo.</i> Resistencia a la helada. Frostbeständigkeit		ISO 10545-12	No surface defects or cracks should be visible Non deve presentare difetti visibili No debe presentar defectos ni grietas superficiales visibles	Frost Resistant Antighiaccio Resistente a la Helada
 <b>Coefficient of friction.</b> <i>Resistenza allo scivolamento.</i> Coeficiente de fricción. Rutschfestigkeit		UNE - ENV 12633	WET TEST/ENSAYO EN HÚMEDO DRY TEST/ENSAYO EN SECO	Clase 1 ** Clase 3 ***
 <b>Colour resistance to light.</b> <i>Resistenza dei colori alla luce.</i> Resistencia del color a la luz. Lichtbeständigkeit der Farben		DIN 51094	There should be no colour variations Non deve presentare difetti visibili No debe presentar variaciones de color	No alterations to colour and shine Non presenta alterazioni di colori e lucentezza No presenta variaciones de color y brillo
CHEMICAL PROPERTIES / PROPIETÀ CHIMICHE / PROPIEADADES QUÍMICAS / CHEMISCHEN EIGENSCHAFTEN				
 <b>Chemical resistance.</b> <i>Resistenza agli agenti chimici.</i> Resistencia química. Chemikalienbeständigkeit		ISO 10545-13	Resistance to household cleaning products and swimmingpools salts. Resistencia a productos domésticos y sales para piscinas	Min. UB
 <b>Resistance to staining.</b> <i>Resistenza alle macchie.</i> Resistencia a las manchas. Fleckenbeständigkeit		ISO 10545-14	≥ 3	5

\*The Land values are the average of different production consignments. For further detail information, please check with our commercial network. /  
I valori dichiarati sono ottenuti da una media di prove effettuate su diverse produzioni. Per avere informazioni dettagliate consultare la rete commerciale /  
Los valores declarados son el promedio obtenido a través de ensayos de diferentes producciones. Para la obtención de una información detallada consultar a la red comercial.

\*\* Test realized in internal laboratory. Provare realizzato in laboratorio interno. Ensayo realizado en laboratorio interno.

\*\*\* Dry Test, according to document DA DB-SUA/3 (Código Técnico de la Edificación) M° de Fomento. Average test result value, on May 2012.  
Ensayo realizado, según documento DA DB-SUA/3 (Código Técnico de la edificación) M° de Fomento, valor medio a fecha Mayo 2012.



AUSTRAL

Austral Copper Estructurado  
44,63x89,46 cm - 22,21x89,46 cm  
29,75x59,55 cm

LAS TABLADILLAS COLLEGE  
Sevilla. (SPAIN)  
Arch. IMBRICE ARQUITECTOS

# LEGNO

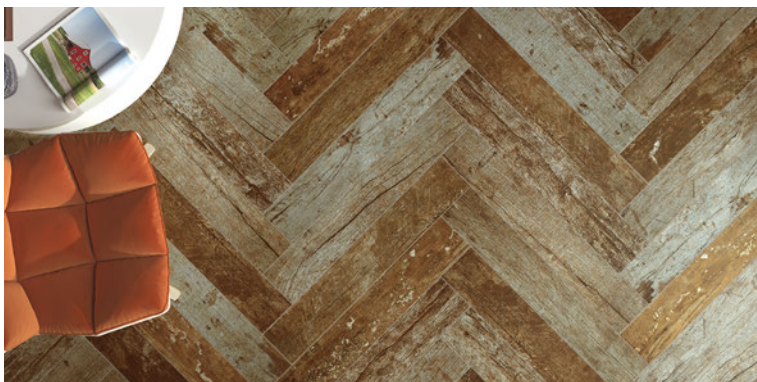

WOOD



\* Legno noce. Content of recycled material. Contenido de material reciclado.

## FORMATS.FORMATI.FORMATOS

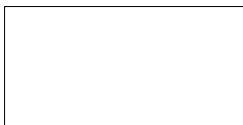

45X90  
44,63x89,46 cm - 17.57"x35.22"



15X90  
14,74x89,46 cm - 5.80"x35.22"

## SPECIAL PIECES.PEZZI SPECIALI.PIEZAS ESPECIALES



15X90 UP  
14,74x88,80 cm - 5.80"x34.96"



15X90 Preincisión irregular  
14,74x89,46 cm - 5.80"x35.22"



30X30 mosaico 5x5  
29,75x29,75 cm - 11.71"x11.71"



Rodapié  
7,3x44,63 cm - 2.92"x17.57"

## THICKNESS.SPESORE.ESPESORES

 1,11 cm / 0.43" approx.

## COLOURS COLORI COLORES



Ice



Noce

## FINISHES FINITURI ACABADOS

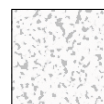

Estructurado

# LEGNO ice

## PLAIN TILES.BASE.BASES



**Legno ice**  
44,63x89,46 cm - 17.57"x35.22"  
G-6194



**Legno ice**  
14,74x89,46 cm - 5.80"x35.22"  
G-6240

## SPECIAL PIECES.PEZZI SPECIALI.PIEZAS ESPECIALES

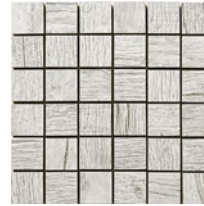

**Legno ice mosaico 5x5**  
29,75 x 29,75 cm - 11.71" x 11.71"  
G-6644



**Legno ice rodapié**  
7,3 x 44,63 cm - 2.87" x 17.57"  
G-5085



**Legno ice preincisión irregular**  
14,74x89,46 cm - 5.80"x35.22"  
G-5211



**Legno ice**  
14,74x88,80 cm - 5.80"x35.22"  
G-5265

\* This is a natural product made through a handmade process, therefore, its possible shade or size variations must be considered as typical features of the material and they will not be admitted in a claim.  
Este es un producto natural fabricado artesanalmente, por lo que posibles variaciones de tono o dimensión deben considerarse propias del material y no será objeto de reclamación.

\* INFO pag 208

## STEPS.GRADINI.PELDAÑOS

SIMPLE 

GRADONE 

pedaño simple 45 (45x90 cm)	5303
pedaño simple 90 (45x90 cm)	5303
pedaño simple áng. (45x90 cm)	5315

pedaño grad-45 (45x90 cm)	5603
pedaño grad-90 (45x90 cm)	5605
pedaño grad áng (45x90 cm)	5623

**Legno**

<b>CLASE 1</b>	<b>R10</b>	<b>DCOF&gt;0.42</b>
UNE - ENV 12633	DIN 51130	ANSI A 137.1 - 2012



Moderna Museet,  
Stockholm Sweden  
10/2-17/3 1968

Never read,  
I just look  
at pictures.  
Andy Warhol  
Moderna Museet,  
Stockholm Sweden  
10/2-17/3 1968

28

LEGNØ

Legno Ice 14,74x89,46 cm - Nouveau Dark Grey Nat. 29,75x29,75 cm

# LEGNO **noce**

## PLAIN TILES.BASE.BASES



### Legno noce

44,63x89,46 cm - 17.57"x35.22"

G-6194



### Legno noce

14,74x89,46 cm - 5.80"x35.22"

G-6240

## SPECIAL PIECES.PEZZI SPECIALI.PIEZAS ESPECIALES



### Legno noce mosaico 5x5

29,75 x 29,75 cm - 11.71" x 11.71"

G-6644



### Legno noce rodapié

7,3 x 44,63 cm - 2.87" x 17.57"

G-5085



### Legno noce preición irregular

14,74x89,46 cm - 5.80"x35.22"

G-5211



### Legno noce

14,74x88,80 cm - 5.80"x35.22"

G-5265

\* This is a natural product made through a handmade process, therefore, its possible shade or size variations must be considered as typical features of the material and they will not be admitted in a claim.  
Este es un producto natural fabricado artesanalmente, por lo que posibles variaciones de tono o dimension deben considerarse propias del material y no será objeto de reclamación.

+ INFO pag 208

## STEPS.GRADINI.PELDAÑOS

SIMPLE



GRADONE



peldaño simple 45 (45x90 cm)	5303
peldaño simple 90 (45x90 cm)	5303
peldaño simple áng. (45x90 cm)	5315

peldaño grad-45 (45x90 cm)	5603
peldaño grad-90 (45x90 cm)	5605
peldaño grad áng (45x90 cm)	5623

Legno

**CLASE 1**

UNE - ENV 12633

**R10**

DIN 51130

**DCOF>0.42**

ANSI A 137.1 - 2012

MONOCALIBER

MONOCALIBRO.MONOCALIBRE

MECHANICAL RESISTANCE

RESISTENZA MECCANICA.RESISTENCIA MECÁNICA

MICROSEALED

MICROSIGILLATURA.MICROSELLADO

RESISTANT TO FROST















INGELIVO.RESISTENTE A LAS HELADAS



LEGNO

Legno Noce 14,74x89,46 cm - Nouveau Random Grey Nat. 29,75x29,75 cm

# TECHNICAL CHARACTERISTICS. CARATTERISTICHE TECNICHE. CARACTERÍSTICAS TÉCNICAS

MEASUREMENTS AND SURFACES APPEARANCE / DIMENSIONI E ASPETTO SUPERFICIALE / MEDIDAS Y ASPECTO SUPERFICIAL / MASSEN UND AUSSEHEN DER OBERFLÄCHE		STANDARD TEST METHOD METODO DELLA NORMA METODO DE ENSAYO STANDARD TEST METHOD	STANDARD PRESCRIBED VALUES VALORE PRESCRITTO VALORES STANDARD NORMA STANDARDWERTE	LENGNO collection *
 <b>Length and width.</b> <i>Lunghezza e larghezza.</i> Longitud y anchura. Länge und Breite		ISO 10545-2	± 0,6% max.	± 0,1% *
 <b>Thickness.</b> <i>Spessore.</i> Grosor. Stärke		ISO 10545-2	± 5% max.	± 2%
 <b>Orthogonality.</b> <i>Ortogonalità.</i> Ortogonalidad. Rechtwinkligkeit		ISO 10545-2	± 0,6% max.	± 0,2% *
 <b>Straightness of sides.</b> <i>Rettilinearità dei lati.</i> Recutud de lados. Kantengeradigkeit		ISO 10545-2	± 0,5% max.	± 0,2% *
 <b>Surfaces flatness.</b> <i>Planarità.</i> Planitud. Ebenflächigkeit		ISO 10545-2	± 0,5% max.	± 0,2% *
PHYSICAL PROPERTIES / PROPRIETÀ FISICHE / PROPIEDADES FÍSICAS / PHYSIKALISCHE EIGENSCHAFTEN				
 <b>Water absorption.</b> <i>Assorbimento d'acqua.</i> Absorción de agua. Wasseraufnahme		ISO 10545-3	≤ 0,5%	≤ 0,1%
 <b>Breaking strength, in N.</b> <i>Carico di rottura, en N.</i> Carga de rotura, en N. Bruchlast, in N	thickness > 7,5 mm spessore > 7,5 mm grösor > 7,5 mm	ISO 10545-4	≥ 1300 N	2400 N *
 <b>Modulus of rupture.</b> <i>Resistenza alla flessione.</i> Resistencia a la flexión. Biegefestigkeit		ISO 10545-4	≥ 35 N/mm <sup>2</sup>	56 N/mm <sup>2</sup> *
 <b>Resistance to deep abrasion.</b> <i>Resistenza all'abrasione profonda.</i> Resistencia a la abrasión profunda. Tiefverschleissbeständigkeit		ISO 10545-6	≤ 175 mm <sup>3</sup>	115 mm <sup>3</sup> *
 <b>Resistance to thermal shock.</b> <i>Resistenza agli sbalzi termici.</i> Resistencia al choque térmico. Temperaturwechselbeständigkeit		ISO 10545-9	No surface defects should be visible Non deve presentare difetti visibili No debe presentar defectos superficiales visibles	Resistant. Resistente. Resistente
 <b>Frost resistance.</b> <i>Resistenza al gelo.</i> Resistencia a la helada. Frostbeständigkeit		ISO 10545-12	No surface defects or cracks should be visible Non deve presentare difetti visibili No debe presentar defectos ni grietas superficiales visibles	Frost Resistance Antighiaccio Resistente a la Helada
 <b>Coefficient of friction.</b> <i>Resistenza allo scivolamento.</i> Coeficiente de fricción. Rutschfestigkeit		DIN 51130 UNE - ENV 12633	WET TEST/ENSAYO EN HÚMEDO DRY TEST/ENSAYO EN SECO	<b>R10**</b> Clase 1 *** Clase 3 **** DCOF - ANSIA 137.1-2012 > 0.42
 <b>Colour resistance to light.</b> <i>Resistenza dei colori alla luce.</i> Resistencia del color a la luz. Lichtbeständigkeit der Farben		DIN 51094	There should be no colour variations Non deve presentare difetti visibili No debe presentar variaciones de color	No alterations in colour and shine Non presentar alterazione di colori e lucidità No presenta variaciones de color y brillo
CHEMICAL PROPERTIES / PROPRIETÀ CHIMICHE / PROPIEDADES QUÍMICAS / CHEMISCHEN EIGENSCHAFTEN				
 <b>Chemical resistance.</b> <i>Resistenza agli agenti chimici.</i> Resistencia química. Chemikalienbeständigkeit		ISO 10545-13	Resistance to household cleaning products and swimmingpools salts. Resistencia a productos domésticos y sales para piscinas	Min. UB
 <b>Resistance to staining.</b> <i>Resistenza alle macchie.</i> Resistencia a las manchas. Fleckenbeständigkeit		ISO 10545-14	≥ 3	5 *

\*The Land values are the average of different production consignments. For further detail information, please check with our commercial network. / I valori dichiarati sono ottenuti da una media di prove effettuate su diverse produzioni. Per avere informazioni dettagliate consultare la rete commerciale / Los valores declarados son el promedio obtenido a través de ensayos de diferentes producciones. Para la obtención de una información detallada consultar a la red comercial.

\*\* R10 - Tested in Legno Noce (batch: 06-14-2014). It depends on the consignment. / Provare realizzato in Legno noce (partita: 14-06-2014). / Ensayo realizado sobre Legno Noce (lote: 14-06-2014).

\*\*\* Clase 1 - Tested in Legno Noce (It depends on the consignment) Test realized in internal laboratory / Provare realizzato in laboratorio interno / Ensayo realizado en laboratorio interno.

\*\*\*\* Dry Test, according to document DA DB-SUA/3 (Código Técnico de la Edificación) M° de Fomento. Test done in LEGNO NOCE 15X90 on October 2014. Ensayo realizado, según documento DA DB-SUA/3 (Código Técnico de la edificación) M° de Fomento, sobre el producto LEGNO NOCE 15X90 a fecha octubre 2014



...Por qué  
-Es un viaje de descubrimiento  
-Pero  
-El instante  
el desapego  
momento de un cambio

LEGN

Legno Noce 44,63x89,46 cm

# LEGNO SLIM

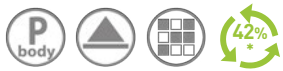

WOOD



\* Legno slim noce. Content of recycled material. Contenido de material reciclado.

FORMATS.FORMATI.FORMATOS



30X90  
29,75x89,46 cm - 11.71"x35.22"

THICKNESS.SPESSORE.ESPESORES

 0,48 cm / 0.19" approx.

COLOURS  
COLORI  
COLORES



Noce

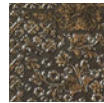

Titanium

FINISHES  
FINITURI  
ACABADOS

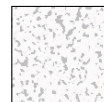

Estructurado

LEGNO SLIM

# LEGNO SLIM **noce - titanium**

PLAIN TILES.BASE.BASES

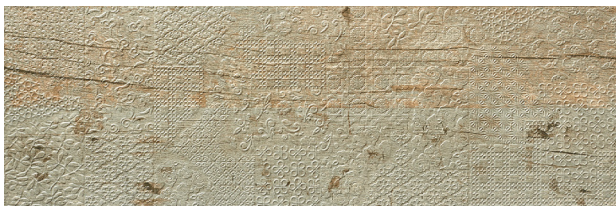

**Legno slim noce \***  
29,75 x 89,46 cm - 11.71" x 35.22"  
**G-6246**

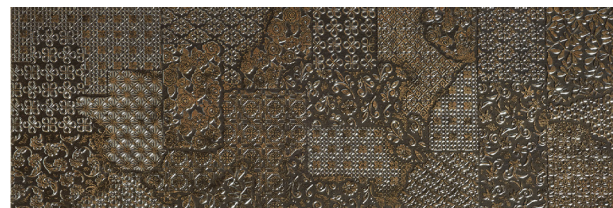

**Legno slim titanium \***  
29,75 x 89,46 cm - 11.71" x 35.22"  
**G-6284**

\* 3 Different aleatory reliefs.  
3 Relieves diferentes aleatorios



LEGNO SLIM

Legno Slim Titanium 29,75x89,46 cm - Portland Slim Vison Nat. 29,75x89,46 cm

# TECHNICAL CHARACTERISTICS. CARATTERISTICHE TECNICHE. CARACTERÍSTICAS TÉCNICAS

MEASUREMENTS AND SURFACES APPEARANCE / DIMENSIONI E ASPETTO SUPERFICIALE / MEDIDAS Y ASPECTO SUPERFICIAL / MASSEN UND AUSSEHEN DER OBERFLÄCHE		STANDARD TEST METHOD METODO DELLA NORMA METODO DE ENSAYO STANDARD TEST METHOD	STANDARD PRESCRIBED VALUES VALORE PRESCRITTO VALORES STANDARD NORMA STANDARDWERTE	<b>LEGNO SLIM</b> *
Length and width. <i>Lunghezza e larghezza.</i> Longitud y anchura. Länge und Breite		ISO 10545-2	± 0,6% max.	± 0,2% *
Orthogonality. <i>Ortogonalità.</i> Ortogonalidad. Rechtwinkligkeit		ISO 10545-2	± 0,6% max.	± 0,2% *
Straightness of sides. <i>Rettilinearità dei lati.</i> Rectitud de lados. Kantengeradigkeit		ISO 10545-2	± 0,5% max.	± 0,2% *
Surfaces flatness. <i>Planarità.</i> Planitud. Ebenföchigkeit		ISO 10545-2	± 0,5% max.	± 0,2% *
PHYSICAL PROPERTIES / PROPRIETÀ FISICHE / PROPIEDADES FÍSICAS / PHYSIKALISCHE EIGENSCHAFTEN				
Water absorption. <i>Assorbimento d'acqua.</i> Absorción de agua. Wasseraufnahme		ISO 10545-3	≤ 0,5%	≤ 0,1%
Breaking strength, in N. <i>Carico di rottura, en N.</i> Carga de rotura, en N. Bruchlast, in N	thickness <75 mm spessore <7,5 mm grosor <75 mm	ISO 10545-4	≥ 700 N	Available Method * Metodo Disponibile Método Disponible
Modulus of rupture <i>Resistenza alla flessione.</i> Resistencia a la flexión. Biegefestigkeit		ISO 10545-4	≥ 35 N/mm <sup>2</sup>	>40 N/mm <sup>2</sup> *
Resistance to thermal shock. <i>Resistenza agli sbalzi termici.</i> Resistencia al choque térmico. Temperaturwechselbeständigkeit		ISO 10545-9	No surface defects should be visible Non deve presentare difetti visibili No debe presentar defectos superficiales visibles	Resistant. Resistente. Resistente
Frost resistance. <i>Resistenza al gelo.</i> Resistencia a la helada. Frostbeständigkeit		ISO 10545-12	No surface defects or cracks should be visible Non deve presentare difetti visibili No debe presentar defectos ni grietas superficiales visibles	Frost Resistant Antighaccio Resistente a la Helada
Coefficient of friction. <i>Resistenza allo scivolamento.</i> Coeficiente de fricción. Rutschfestigkeit		DIN 51130		Available Method Metodo Disponibile Método Disponible
Colour resistance to light. <i>Resistenza dei colori alla luce.</i> Resistencia del color a la luz. Lichtbeständigkeit der Farben		DIN 51094	There should be no colour variations Non deve presentare difetti visibili No debe presentar variaciones de color	No alterations in colour and shine Non presentar alterazioni di colore e lucentezza No presenta variaciones de color y brillo
CHEMICAL PROPERTIES / PROPRIETÀ CHIMICHE / PROPIEDADES QUÍMICAS / CHEMISCHEN EIGENSCHAFTEN				
Chemical resistance. <i>Resistenza agli agenti chimici.</i> Resistencia química. Chemikalienbeständigkeit		ISO 10545-13	Resistance to household cleaning products and swimmingpools salts. Resistenza a prodotti d'igiene e sale per piscine	Min.GB
Resistance to staining. <i>Resistenza alle macchie.</i> Resistencia a las manchas. Fleckenbeständigkeit		ISO 10545-14	≥ 3	5 **

\*The Land values are the average of different production consignments. For further detail information, please check with our commercial network. /  
I valori dichiarati sono ottenuti da una media di prove effettuate su diverse produzioni. Per avere informazioni dettagliate consultare la rete commerciale. /  
Los valores declarados son el promedio obtenido a través de ensayos de diferentes producciones. Para la obtención de una información detallada consultar a la red comercial.

\*\* Tested in LegnoSlim Noce. Test realized in internal laboratory. Legno Slim Titanium - Metallized finish. For projects check technical information with our commercial networks. /  
Prova realizzata in laboratorio interno su Legno Slim Noce. Legno Slim Titanium - finitura metallica. Per avere informazioni dettagliate consultare la rete commerciale. /  
Ensayo realizado en laboratorio interno sobre Legno Slim Noce. Legno Slim Titanium - acabado metalizado. Para proyectos obtenga información técnica a través de nuestra red comercial.

## ADVANTAGES. VANTAGGI. VENTAJAS

- Time. *Tempo.* Tiempo
- Money. *Denaro.* Dinero
- Hygiene. *Igiene.* Higiene
- Ecologic. *Ecologia.* Ecología
- Technology. *Tecnologia.* Tecnología

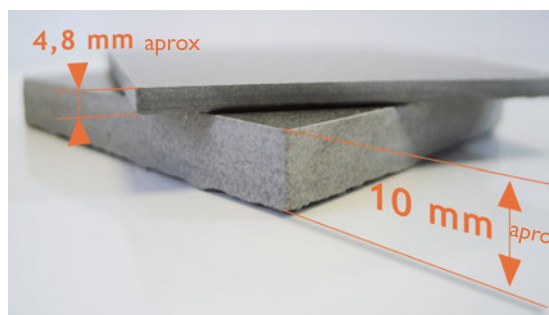

\* Recommended only for wall. /  
sólo recomendado como revestimiento.

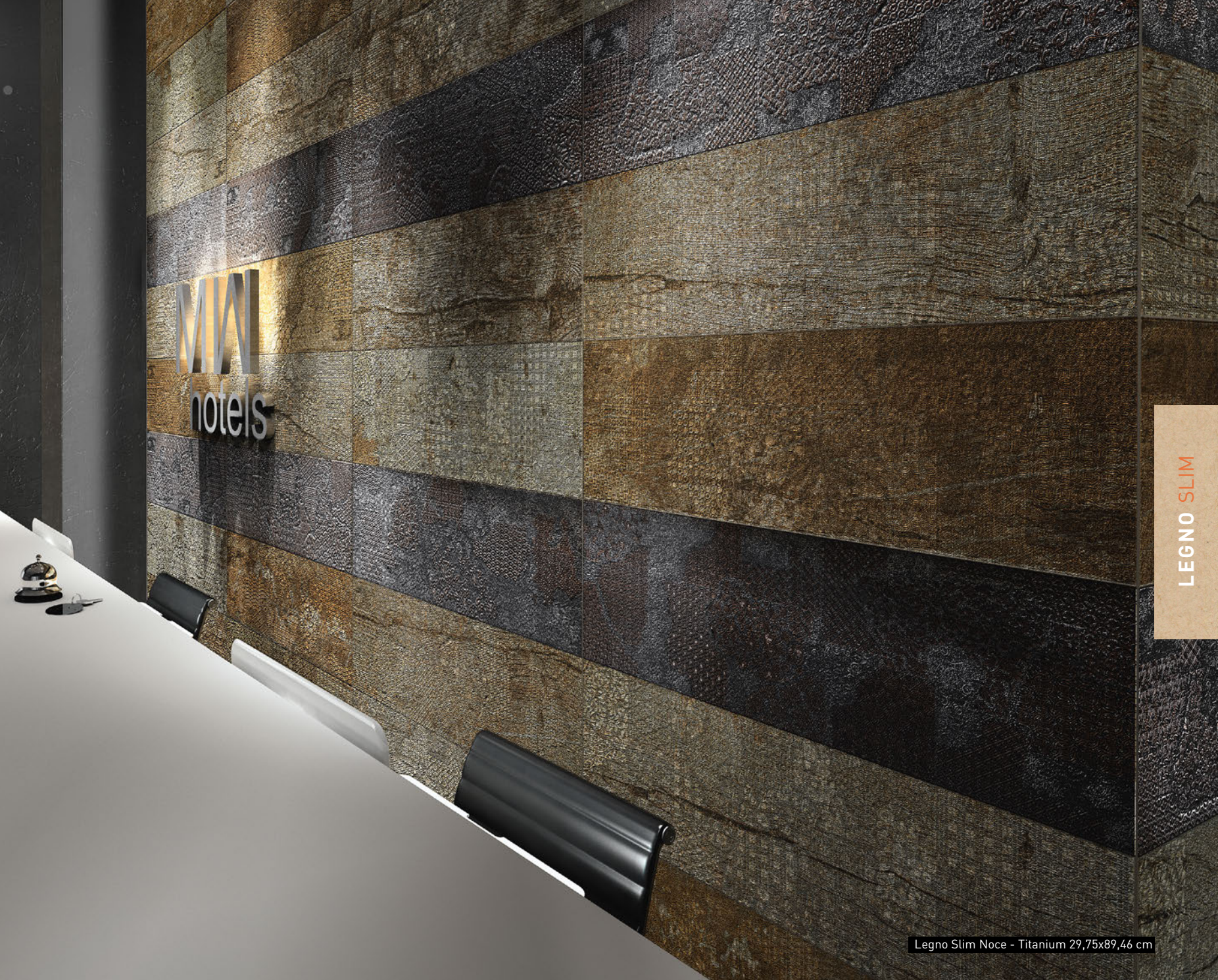

MNH  
hotels

LEGNO SLIM

Legno Slim Noce - Titanium 29,75x89,46 cm

# ROOTS



## WOOD



\* Roots maple. Content of recycled material. Contenido de material reciclado.

## FORMATS.FORMATI.FORMATOS



**60X120**  
59,55x119,3 cm - 23.45"x46.97"



**20X120**  
19,71x119,3 cm - 7.76"x46.97"



**30X120**  
29,67x119,3 cm - 11.68"x46.97"



**15X120**  
14,73x119,3 cm - 5.80"x46.97"

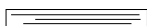

**7,5X60 listelo A**  
7,3x59,55 cm - 2.87"x23.45"



**7,5X60 listelo C**  
7,3x59,55 cm - 2.87"x23.45"

## SPECIAL PIECES.PEZZI SPECIALI.PIEZAS ESPECIALES

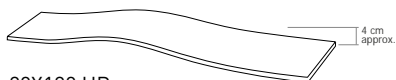

**20X120 UP**  
19,71X118,80 cm - 7.76"x46.77"



**30X30 mosaico 5x10**  
29,75x29,75 cm - 11.71"x11.71"



**30X30 mosaico multicolor 5x10**  
29,75x29,75 cm - 11.71"x11.71"



**30X30 módulo 15x15**  
29,75x29,75 cm - 11.71"x11.71"

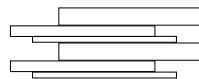

**30X60 muretto**  
29,75x59,55 cm - 11.71"x23.45"



**7,5X60 rodapié**  
7,3x59,55 cm - 2.87"x23.45"

## THICKNESS.SPESORE.ESPESORES

 1,18 cm / 0.46" approx.

## COLOURS COLORI COLORES



**White**



**Maple**



**Oak**

## FINISHES FINITURI ACABADOS

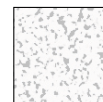

**Estructurado**

# ROOTS **white**

PLAIN TILES.BASE.BASES



**Roots white**  
59,55 x 119,3 cm - 23.45" x 46.97"  
G-6466



**Roots white**  
29,67 x 119,3 cm - 7.76" x 46.97"  
G-6496



**Roots white**  
19,71 x 119,3 cm - 7.76" x 46.97"  
G-6496



**Roots white**  
14,73 x 119,3 cm - 5.80" x 46.97"  
G-6496

\* This is a natural product made through a handmade process, therefore, its possible shade or size variations must be considered as typical features of the material and they will not be admitted in a claim.  
Este es un producto natural fabricado artesanalmente, por lo que posibles variaciones de tono o dimension deben considerarse propias del material y no será objeto de reclamación.

**Roots** **CLASE 3** **R11** **DCOF>0.42**  
UNE - ENV 12633 DIN 51130 ANSI A 137.1 - 2012

## SPECIAL PIECES.PEZZI SPECIALI.PIEZAS ESPECIALES

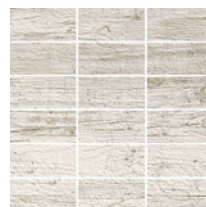

**Roots white mosaico 5x10**  
29,75 x 29,75 cm - 11.71" x 11.71"  
G-6756



**Roots multicolor mosaico 5x10**  
29,75 x 29,75 cm - 11.71" x 11.71"  
G-6756



**Roots módulo 15x15**  
29,75 x 29,75 cm - 11.71" x 11.71"  
G-5243



**Roots white muretto**  
29,75 x 59,55 cm - 11.71" x 23.45"  
G-6756



**Roots white rodapié 60**  
7,3 x 59,55 cm - 2.87" x 23.45"  
G-5097



**Roots white up\***  
19,71 x 118,8 cm - 7.76" x 46.77"  
G-5435

+ INFO pag. 208





**Roots white listelo A**  
7,3 x 59,55 cm - 2.87" x 23.45"  
G-5089



**Roots white listelo C**  
7,3 x 59,55 cm - 2.87" x 23.45"  
G-5089

## STEPS.GRADINI.PELDAÑOS

**SIMPLE**   
peldaño simple 120 (30x120 cm) 5519

**GRADONE**   
peldaño grad-120 (30x120 cm) 5795  
peldaño grad áng (30x120 cm) 5815

**STEP**   
step 120 (30x120 cm) 5795  
+ INFO pag. 207



ROOTS

Roots White 14,73x119,3cm\_Roots Maple Mosaico 5x10\_Roots Modulo 15x15

# ROOTS maple

PLAIN TILES.BASE.BASES



**Roots maple**  
59,55 x 119,3 cm - 23.45" x 46.97"  
G-6466



**Roots maple**  
29,67 x 119,3 cm - 7.76" x 46.97"  
G-6496



**Roots maple**  
19,71 x 119,3 cm - 7.76" x 46.97"  
G-6496



**Roots maple**  
14,73 x 119,3 cm - 5.80" x 46.97"  
G-6496

\* This is a natural product made through a handmade process, therefore, its possible shade or size variations must be considered as typical features of the material and they will not be admitted in a claim.  
\* Este es un producto natural fabricado artesanalmente, por lo que posibles variaciones de tono o dimension deben considerarse propias del material y no será objeto de reclamación.

**Roots** **CLASE 3** **R11** **DCOF>0.42**  
UNE - ENV 12633 DIN 51130 ANSI A 137.1 - 2012

## SPECIAL PIECES.PEZZI SPECIALI.PIEZAS ESPECIALES

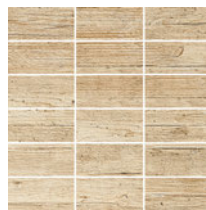

**Roots maple mosaico 5x10**  
29,75 x 29,75 cm - 11.71" x 11.71"  
G-6756



**Roots multicolor mosaico 5x10**  
29,75 x 29,75 cm - 11.71" x 11.71"  
G-6756



**Roots módulo 15x15**  
29,75 x 29,75 cm - 11.71" x 11.71"  
G-5243



**Roots maple muretto**  
29,75 x 59,55 cm - 11.71" x 23.45"  
G-6756

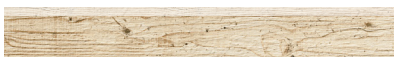

**Roots maple rodapié 60**  
7,3 x 59,55 cm - 2.87" x 23.45"  
G-5097



**Roots maple up\***  
19,71 x 118,8 cm - 7.76" x 46.77"  
G-5435

+ INFO pag. 208





**Roots maple listelo A**  
7,3 x 59,55 cm - 2.87" x 23.45"  
G-5089



**Roots maple listelo C**  
7,3 x 59,55 cm - 2.87" x 23.45"  
G-5089

## STEPS.GRADINI.PELDAÑOS

**SIMPLE**   
peldaño simple 120 (30x120 cm) 5519

**GRADONE**   
peldaño grad-120 (30x120 cm) 5795  
peldaño grad áng (30x120 cm) 5815

**STEP**   
step 120 (30x120 cm) 5795  
+ INFO pag. 207



ROOTS

Roots Maple 14,73x119,3 cm - 19,71x119,3 cm - 29,67x119,3 cm

# ROOTS oak

PLAIN TILES.BASE.BASES



**Roots oak**  
59,55 x 119,3 cm - 23.45" x 46.97"  
G-6466



**Roots oak**  
29,67 x 119,3 cm - 7.76" x 46.97"  
G-6496



**Roots oak**  
19,71 x 119,3 cm - 7.76" x 46.97"  
G-6496



**Roots oak**  
14,73 x 119,3 cm - 5.80" x 46.97"  
G-6496

\* This is a natural product made through a handmade process, therefore, its possible shade or size variations must be considered as typical features of the material and they will not be admitted in a claim.  
\* Este es un producto natural fabricado artesanalmente, por lo que posibles variaciones de tono o dimension deben considerarse propias del material y no será objeto de reclamación.

**Roots** **CLASE 3** **R11** **DCOF>0.42**  
UNE - ENV 12633 DIN 51130 ANSI A 137.1 - 2012

## SPECIAL PIECES.PEZZI SPECIALI.PIEZAS ESPECIALES

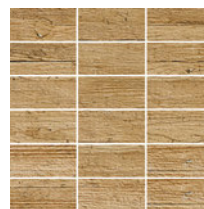

**Roots oak mosaico 5x10**  
29,75 x 29,75 cm - 11.71" x 11.71"  
G-6756



**Roots multicolor mosaico 5x10**  
29,75 x 29,75 cm - 11.71" x 11.71"  
G-6756



**Roots módulo 15x15**  
29,75 x 29,75 cm - 11.71" x 11.71"  
G-5243



**Roots oak muretto**  
29,75 x 59,55 cm - 11.71" x 23.45"  
G-6756



**Roots oak rodapié 60**  
7,3 x 59,55 cm - 2.83" x 23.45"  
G-5097



**Roots oak up**  
19,71 x 118,8 cm - 7.76" x 46.77"  
G-5435  
+ INFO pag. 208





**Roots oak listelo A**  
7,3 x 59,55 cm - 2.87" x 23.45"  
G-5089



**Roots oak listelo C**  
7,3 x 59,55 cm - 2.87" x 23.45"  
G-5089

## STEPS.GRADINI.PELDAÑOS

**SIMPLE**   
peldaño simple 120 (30x120 cm) 5519

**GRADONE**   
peldaño grad-120 (30x120 cm) 5795  
peldaño grad áng (30x120 cm) 5815















**STEP**   
step 120 (30x120 cm) 5795  
+ INFO pag. 221



ROOTS

Roots Oak 29,67x119,3 cm / Roots Oak Gradone 29,67x119,3 cm

# TECHNICAL CHARACTERISTICS. CARATTERISTICHE TECNICHE. CARACTERÍSTICAS TÉCNICAS

MEASUREMENTS AND SURFACES APPEARANCE / DIMENSIONI E ASPETTO SUPERFICIALE / MEDIDAS Y ASPECTO SUPERFICIAL / MASSEN UND AUSSEHEN DER OBERFLÄCHE		STANDARD TEST METHOD METODO DELLA NORMA METODO DE ENSAYO STANDARD TEST METHOD	STANDARD PRESCRIBED VALUES VALORE PRESCRITTO VALORES STANDARD NORMA STANDARDWERTE	ROOTS collection *
 Length and width. <i>Lunghezza e larghezza.</i> Longitud y anchura. Länge und Breite		ISO 10545-2	± 0,6% max.	± 0,1% *
 Thickness. <i>Spessore.</i> Grosor. Stärke		ISO 10545-2	± 5% max.	± 2% *
 90° Orthogonality. <i>Ortogonalità.</i> Ortogonalidad. Rechtwinkligkeit		ISO 10545-2	± 0,6% max.	± 0,2% *
 Straightness of sides. <i>Rettilinearità dei lati.</i> Rectitud de lados. Kantengeradigkeit		ISO 10545-2	± 0,5% max.	± 0,2% *
 Surfaces flatness. <i>Planarità.</i> Planitud. Ebenföchigkeit		ISO 10545-2	± 0,5% max.	± 0,2% *
PHYSICAL PROPERTIES / PROPIETÀ FISICHE / PROPIEDADES FÍSICAS / PHYSIKALISCHE EIGENSCHAFTEN				
 Water absorption. <i>Assorbimento d' acqua.</i> Absorción de agua. Wasseraufnahme		ISO 10545-3	≤ 0,5%	≤ 0,1%
 Breaking strength, in N. <i>Carico di rottura, en N.</i> Carga de rotura, en N. Bruchlast, in N	thickness > 7,5 mm spessore > 7,5 mm grosor > 7,5 mm	ISO 10545-4	≥ 1300 N	2400 N *
 Modulus of rupture. <i>Resistenza alla flessione.</i> Resistencia a la flexión. Biegefestigkeit		ISO 10545-4	≥ 35 N/mm <sup>2</sup>	56 N/mm <sup>2</sup> *
 Resistance to deep abrasion. <i>Resistenza all' abrasione profonda.</i> Resistencia a la abrasión profunda. Tiefverschleissbeständigkeit		ISO 10545-6	≤ 175 mm <sup>3</sup>	110 mm <sup>3</sup> *
 Resistance to thermal shock. <i>Resistenza agli sbalzi termici.</i> Resistencia al choque térmico. Temperaturwechselbeständigkeit		ISO 10545-9	No surface defects should be visible Non deve presentare difetti visibili No debe presentar defectos superficiales visibles	Resistant. Resistente. Resistente
 Frost resistance. <i>Resistenza al gelo.</i> Resistencia a la helada. Frostbeständigkeit		ISO 10545-12	No surface defects or cracks should be visible Non deve presentare difetti visibili No debe presentar defectos ni grietas superficiales visibles	Frost Resistance Antighaccio Resistente a la Helada
 Coefficient of friction. <i>Resistenza allo scivolamento.</i> Coeficiente de fricción. Rutschfestigkeit		DIN 51130 UNE - ENV 12633	WET TEST/ENSAYO EN HÚMEDO DRY TEST/ENSAYO EN SECO	R11** Clase 3 ** Clase 3*** DCOF - ANSIA 137.1-2012 > 0.42
 Colour resistance to light. <i>Resistenza dei colori alla luce.</i> Resistencia del color a la luz. Lichtbeständigkeit der Farben		DIN 51094	There should be no colour variations Non deve presentare difetti visibili No debe presentar variaciones de color	No alterations in colour and shine Non presenta alterazioni di colori e lucentezza No presenta variaciones de color y brillo
CHEMICAL PROPERTIES / PROPIETÀ CHIMICHE / PROPIEDADES QUÍMICAS / CHEMISCHEN EIGENSCHAFTEN				
 Chemical resistance. <i>Resistenza agli agenti chimici.</i> Resistencia química. Chemikalienbeständigkeit		ISO 10545-13	Resistance to household cleaning products and swimmingpools salts. Resistencia a productos domesticos y sales para piscinas	Min UB
 Resistance to staining. <i>Resistenza alle macchie.</i> Resistencia a las manchas. Fleckenbeständigkeit		ISO 10545-14	≥ 3	5 *

\*The Land values are the average of different production consignments. For further detail information, please check with our commercial network. / I valori dichiarati sono ottenuti da una media di prove effettuate su diverse produzioni. Per avere informazioni dettagliate consultare la rete commerciale / Los valores declarados son el promedio obtenido a través de ensayos de diferentes producciones. Para la obtención de una información detallada consultar a la red comercial.

\*\* R11 - Test carried out on Roots Maple 30x120 (Batch 30-05-13). Ensayo realizado sobre el producto Roots Maple 30x120 (Lote 30-05-13)

\*\* Clase 3 - Test carried out on Roots Maple 30x120, on June 2013. Test realized in internal laboratory. Ensayo realizado en laboratorio interno.

\*\* TESTED ON SAMPLES FROM FIRST PRODUCTION BATCH. PLEASE CHECK SPECIFIC VALUE WITH OUR COMMERCIAL NETWORK BEFORE CONFIRMING THE ORDER.

ENSAYOS REALIZADOS EN PRIMERA PRODUCCIÓN, CONSULTAR DATOS DEL PRODUCTO ESPECÍFICO ANTES DE CONFIRMAR EL PEDIDO PARA PROYECTOS QUE PRECISEN DICHS VALORES.

\*\*\* Dry Test, according to document DA DB-SUA/3 (Código Técnico de la Edificación) M° de Fomento. Average test result value, on May 2012.

Ensayo realizado, según documento DA DB-SUA/3 (Código Técnico de la edificación) M° de Fomento. Valor medio a fecha Mayo 2012.



ROOTS

Roots maple 19,71x119,3 cm

# MENSA



COSTA AZUL HOTEL \*\*\*\*  
Palma de Mallorca. (SPAIN)  
Arch. Juan de Luna

## WOOD



CASA ANA COFFEE SHOP  
Castellón. (SPAIN)

\* Mensa savanna. Content of recycled material. Contenido de material reciclado.

## FORMATS.FORMATI.FORMATOS



45X90  
44,63x89,46 cm - 17.57"x35.22"

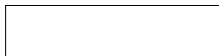

22,5X90  
22,21x89,46 cm - 8.75"x35.22"

## SPECIAL PIECES.PEZZI SPECIALI.PIEZAS ESPECIALES



7,5X45 rodapié  
7,3x44,63 cm - 2.87"x17.57"

## THICKNESS.SPESORE.ESPESORES

 1,11 cm / 0.44" approx.

## COLOURS COLORI COLORES

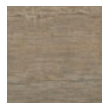

**Savanna**

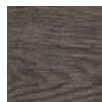

**Graphite**

## FINISHES FINITURI ACABADOS



**Natural**

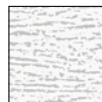

**Non-slip**

MENSA

# MENSA savanna - graphite

PLAIN TILES.BASE.BASES



**Mensa savanna**  
44,63 x 89,46 cm - 17.57" x 35.22"  
G-6330



**Mensa graphite**  
44,63 x 89,46 cm - 17.57" x 35.22"  
G-6330



**Mensa savanna**  
22,21 x 89,46 cm - 8.75" x 35.22"  
G-6392



**Mensa graphite / non slip**  
22,21 x 89,46 cm - 8.75" x 35.22"  
G-6392 / 6416

## SPECIAL PIECES. PEZZI SPECIALI.PIEZAS ESPECIALES



**Mensa savanna rodapié 45**  
7,3 x 44,63 cm - 2.87" x 17.57"  
G-5087



**Mensa graphite rodapié 45**  
7,3 x 44,63 cm - 2.87" x 17.57"  
G-5087

## STEPS.GRADINI.PELDAÑOS

SIMPLE		pedaño simple-90 (45x90 cm)	natural	5315
		pedaño áng. 90 (45x90 cm)		5323
GRADONE		pedaño grad-90 (45x90 cm)	natural	5623
		pedaño grad. áng. (45x90 cm)		5645

+ INFO pag. 221

**Mensa non slip** **CLASE 3**  
UNE - ENV 12633















**Mensa natural** **CLASE 1**  
UNE - ENV 12633



Mensa Savanna 22,21x89,46 cm

PHARMACY  
Barcelona. (SPAIN)

# TECHNICAL CHARACTERISTICS. CARATTERISTICHE TECNICHE. CARACTERÍSTICAS TÉCNICAS

MEASUREMENTS AND SURFACES APPEARANCE / DIMENSIONI E ASPETTO SUPERFICIALE / MEDIDAS Y ASPECTO SUPERFICIAL / MASSEN UND AUSSEHEN DER OBERFLÄCHE		STANDARD TEST METHOD METODO DELLA NORMA METODO DE ENSAYO STANDARD TEST METHOD	STANDARD PRESCRIBED VALUES VALORE PRESCRITTO VALORES STANDARD NORMA STANDARDWERTE	MENSA collection *
 Length and width. <i>Lunghezza e larghezza.</i> Longitud y anchura. Länge und Breite		ISO 10545-2	± 0,6% max.	± 0,1%
 Thickness. <i>Spessore.</i> Grosor. Stärke		ISO 10545-2	± 5% max.	± 2%
 90° Orthogonality. <i>Ortogonalità.</i> Ortogonalidad. Rechtwinkligkeit		ISO 10545-2	± 0,6% max.	± 0,2%
 Straightness of sides. <i>Rettilinearità dei lati.</i> Rectitud de lados. Kantengeradigkeit		ISO 10545-2	± 0,5% max.	± 0,2%
 Surfaces flatness. <i>Planarità.</i> Planitud. Ebenföchigkeit		ISO 10545-2	± 0,5% max.	± 0,2%
PHYSICAL PROPERTIES / PROPIETÀ FISICHE / PROPIEDADES FÍSICAS / PHYSIKALISCHE EIGENSCHAFTEN				
 Water absorption. <i>Assorbimento d' acqua.</i> Absorción de agua. Wasseraufnahme		ISO 10545-3	≤ 0,5%	0,1%
 Breaking strength, in N. <i>Carico di rottura, en N.</i> Carga de rotura, en N. Bruchlast, in N	thickness > 7,5 mm spessore > 7,5 mm grosor > 7,5 mm	ISO 10545-4	≥ 1300 N	2400 N*
 Modulus of rupture. <i>Resistenza alla flessione.</i> Resistencia a la flexión. Biegefestigkeit		ISO 10545-4	≥ 35 N/mm <sup>2</sup>	52 N/mm <sup>2</sup> *
 Resistance to deep abrasion. <i>Resistenza all' abrasione profonda.</i> Resistencia a la abrasión profunda. Tiefverschleissbeständigkeit		ISO 10545-6	≤ 175 mm <sup>3</sup>	112 mm <sup>3</sup> *
 Resistance to thermal shock. <i>Resistenza agli sbalzi termici.</i> Resistencia al choque térmico. Temperaturwechselbeständigkeit		ISO 10545-9	No surface defects should be visible Non deve presentare difetti visibili No debe presentar defectos superficiales visibles	Resistant. Resistente. Resistente
 Frost resistance. <i>Resistenza al gelo.</i> Resistencia a la helada. Frostbeständigkeit		ISO 10545-12	No surface defects or cracks should be visible Non deve presentare difetti visibili No debe presentar defectos ni grietas superficiales visibles	Frost Resistant Antighiaccio Resistente a la Helada
 Coefficient of friction. <i>Resistenza allo scivolamento.</i> Coeficiente de fricción. Rutschfestigkeit		UNE - ENV 12633	WET TEST/ENSAYO EN HÚMEDO DRY TEST/ENSAYO EN SECO	Clase 1 - Clase 3** Clase 3***
 Colour resistance to light. <i>Resistenza dei colori alla luce.</i> Resistencia del color a la luz. Lichtbeständigkeit der Farben		DIN 51094	There should be no colour variations Non deve presentare difetti visibili No debe presentar variaciones de color	No alterations to colour and shine Non presenta alterazioni di colori e lucentezza No presenta variaciones de color y brillo
CHEMICAL PROPERTIES / PROPIETÀ CHIMICHE / PROPIEDADES QUÍMICAS / CHEMISCHEN EIGENSCHAFTEN				
 Chemical resistance. <i>Resistenza agli agenti chimici.</i> Resistencia química. Chemikalienbeständigkeit		ISO 10545-13	Resistance to household cleaning products and swimmingpool salts. Resistencia a productos domésticos y sales para piscinas	Min. UB
 Resistance to staining. <i>Resistenza alle macchie.</i> Resistencia a las manchas. Fleckenbeständigkeit		ISO 10545-14	≥ 3	5

\*The Land values are the average of different production consignments. For further detail information, please check with our commercial network. / I valori dichiarati sono ottenuti da una media di prove effettuate su diverse produzioni. Per avere informazioni dettagliate consultare la rete commerciale / Los valores declarados son el promedio obtenido a través de ensayos de diferentes producciones. Para la obtención de una información detallada consultar a la red comercial.

\*\* Clase 1 - Tested in natural finish. Test realized in internal laboratory. Provare realizzato in laboratorio interno. Ensayo realizado en laboratorio interno.

\*\* Clase 3 - Tested in non slip finish. Test realized in internal laboratory. Provare realizzato in laboratorio interno. Ensayo realizado en laboratorio interno.

\*\*\* Dry Test, according to document DA DB-SUA/3 (Código Técnico de la Edificación) M° de Fomento. Average test result value, on May 2012. Ensayo realizado, según documento DA DB-SUA/3 (Código Técnico de la edificación) M° de Fomento, valor medio a fecha Mayo 2012.



Mensa Savanna Non-slip 22,21x89,46 cm

COSTA AZUL HOTEL \*\*\*\*  
Palma de Mallorca. [SPAIN]  
Arch. Juan de Luna

MENSA

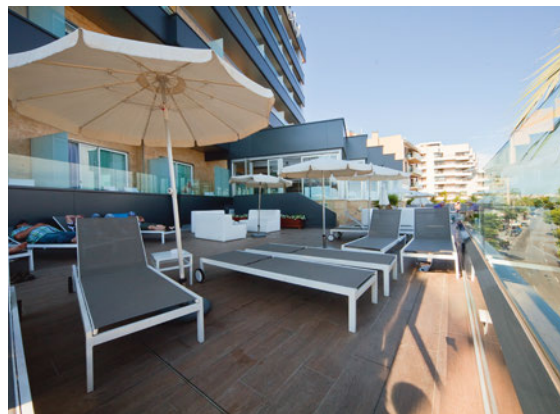

# GALLERY



## COLOURS

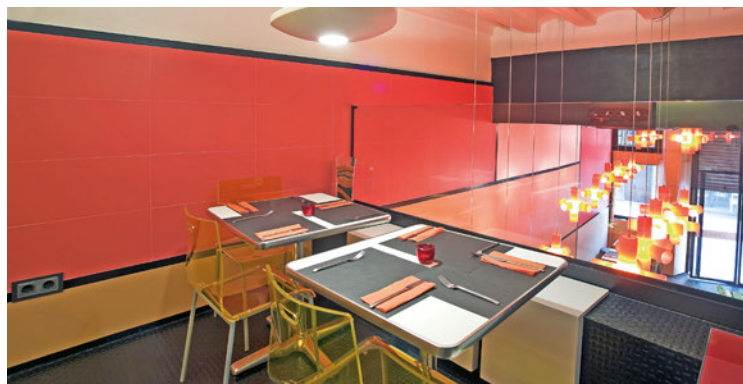

SANDWICH & FRIENDS RESTAURANT  
Barcelona. (SPAIN)  
Interior Design. AIXUT ALVARADO  
DECORADORS



POLO DIREZIONALE DE CECCO  
Pescara. (ITALY)  
Arch. Massimiliano FUKSAS

\* Gallery black sat. Content of recycled material. Contenido de material reciclado.

## FORMATS.FORMATI.FORMATOS

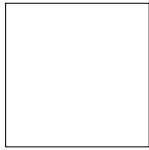

**60X60**  
59,55x59,55 cm  
23.45"x23.45"



**30X60**  
29,75x59,55 cm - 11.71"x23.45"

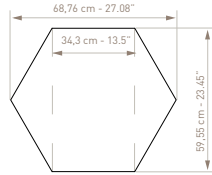

**Hexagonal**  
59,55x51,57 cm  
23.45"x20.31"

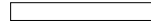

**7,5X60**  
7,3x59,55 cm - 2.87"x23.45"

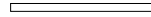

**3,5X60**  
3,5x59,55 cm - 1.38"x23.45"



**7,5X7,5**  
7,3x7,3 cm - 2.87"x2.87"

## SPECIAL PIECES.PEZZI SPECIALI.PIEZAS ESPECIALES

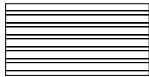

**30X60 righe**  
29,75x59,55 cm - 11.71"x23.45"



**30X30 mosaico 2,5x2,5**  
29,75x29,75 cm - 11.71"x11.71"

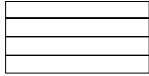

**30X60 preincisión 7,5x60**  
29,75x59,55 cm - 11.71"x23.45"



**30X30 mosaico 2,5x10**  
29,75x29,75 cm - 11.71"x11.71"

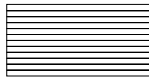

**30X60 preincisión 2,5x60**  
29,75x59,55 cm - 11.71"x23.45"



**30X60 b-insert**  
29,75x59,55 cm - 11.71"x23.45"



**Inserto**  
R 12,5 cm - R 5"

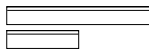

**7,5X60 rodapié**  
**7,5X30 rodapié**  
7,3x59,55 cm - 2.87"x23.45"  
7,3x29,75 cm - 2.87"x11.71"

## THICKNESS.SPESSORE.ESPESORES

— 1,01 cm / 0.35" - 0.40" approx.

— 0,90 - 1,00 cm / 0.35" - 0.39" approx.

Hexagonal / 60x60cm FORMATS

30x60cm FORMAT

## COLOURS COLORI COLORES



**White**



**Yellow**



**Orange**



**Lime**



**Red**



**Blue**



**Black**

## FINISHES FINITURI ACABADOS



**Polido**



**Satinado**



**Righe**

# GALLERY white

PLAIN TILES.BASE.BASES



**Gallery white satinado hexagonal**

59,55 x 51,57 cm - 23.45" x 20.31"

G-6558

3 mm joint are recommended for hexagonal sizes.  
para formatos hexagonales se recomienda una junta de separación de 3 mm.

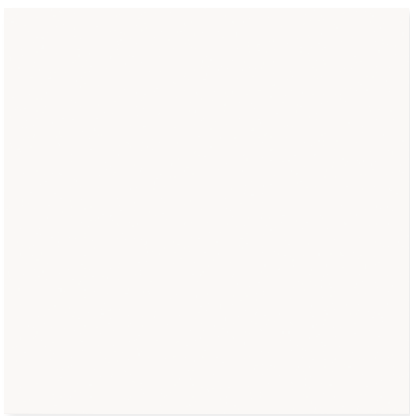

**Gallery white pulido / satinado**

59,55 x 59,55 cm - 23.45" x 23.45"

G-6516 / 6458

Gallery satinado

**CLASE 1**

UNE - ENV 12633

**DCOF>0.42**

ANSI A 137.1 - 2012

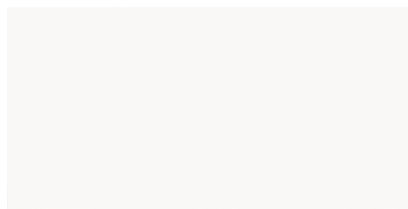

**Gallery white pulido / satinado**

29,75 x 59,55 cm - 11.71" x 23.45"

G-6456 / 6364



**Gallery white righe**

29,75 x 59,55 cm - 11.71" x 23.45"

G-6404

SPECIAL PIECES.PEZZI SPECIALI.PIEZAS ESPECIALES



**Gallery white pulido preincisión 2,5x60**

29,75 x 59,55 cm - 11.71" x 23.45"

G-6666



**Gallery white pulido preincisión 7,5x60**

29,75 x 59,55 cm - 11.71" x 23.45"

G-6666

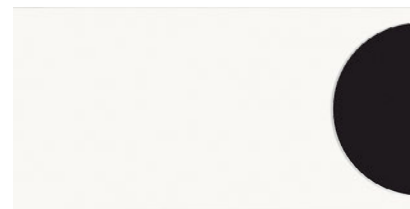

**Gallery white satinado b-insert\***

29,75 x 59,55 cm - 11.71" x 23.45"

G-5283

**Gallery black satinado inserto\***

R 12,8 cm - R 5"

G-5149



**Gallery black satinado b-insert\***

29,75 x 59,55 cm - 11.71" x 23.45"

G-5283

**Gallery white satinado inserto\***

R 12,8 cm - R 5"

G-5149

\* insert and b-insert are sold separately. /  
insert y b-insert se venden por separado.

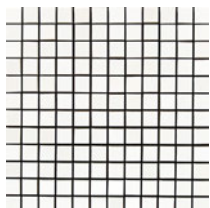

**Gallery white satinado  
mosaico 2,5x2,5**  
29,75 x 29,75 cm - 11.71" x 11.71"  
G-6868

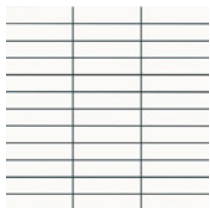

**Gallery white pulido  
mosaico 2,5x10**  
29,75 x 29,75 cm - 11.71" x 11.71"  
G-6868



**Gallery white  
pulido / satinado taco**  
7,3 x 7,3 cm - 2.87" x 2.87"  
G-5027 / 5025

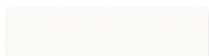

**Gallery white pulido listelo-30**  
7,3 x 29,75 cm - 2.87" x 11.71"  
G-5075

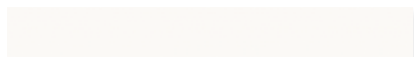

**Gallery white pulido / satinado listelo**  
7,3 x 59,55 cm - 2.87" x 23.45"  
G-5111 / 5097

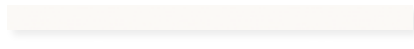

**Gallery white pulido lista**  
3,3 x 59,55 cm - 1.38" x 23.45"  
G-5100



**Gallery white satinado rodapié 30**  
7,3 x 29,75 cm - 2.87" x 11.71"  
G-5081

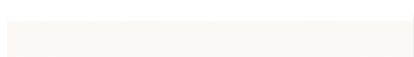

**Gallery white pulido / satinado rodapié 60**  
7,3 x 59,55 cm - 2.87" x 23.45"  
G-5125 / 5119

## STEPS. GRADINI.PELDAÑOS

SIMPLE		pulido satinado	
		5345	5291
	peldaño simple-30 (30x60 cm)	5345	5291
	peldaño simple-60 (30x60 cm)	5345	5291
	peldaño simple áng. (30x60 cm)	5375	5319
	peldaño simple-60 (60x60 cm)	5501	5501
	peldaño simple áng. (60x60 cm)	5515	5515

GRADONE		pulido satinado	
		5623	5603
	peldaño grad-30 (30x60 cm)	5623	5603
	peldaño grad-60 (30x60 cm)	5623	5603
	peldaño grad. áng. (30x60 cm)	5691	5667
	peldaño grad-60 (60x60 cm)	5609	5609
	peldaño simple áng. (60x60 cm)	5655	5655

\* INFO pag 207

## COMPLEMENTS.COMPLEMENTI. COMPLEMENTOS



**Byte ice / yellow / red / black lista 60\***  
1,5 x 59,55 cm - 0.59" x 23.45"  
G-5100



**Pod white / ice / yellow / orange / red / purple / blue / black lista 60\***  
1,5 x 59,55 cm - 0.59" x 23.45"  
G-5100

**Fusion natural lista 60\***  
1 x 59,55 cm - 0.39" x 23.45"  
G-5049

**Fusion graffiato lista 60**  
1,5 x 59,55 cm - 0.59" x 23.45"  
G-5069

\* recommended only for walls



Gallery White - Black Satinado Hexagonal 59,55x51,57 cm

# GALLERY yellow

PLAIN TILES.BASE.BASES

SPECIAL PIECES.PEZZI SPECIALI.PIEZAS ESPECIALES



**Gallery yellow pulido / satinado**  
29,75 x 59,55 cm - 11.71" x 23.45"  
G-6456 / 6364

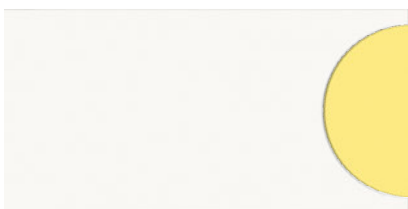

**Gallery white satinado b-insert\***  
29,75 x 59,55 cm - 11.71" x 23.45"  
G-5283

**Gallery yellow satinado inserto\***  
R 12,8 cm - R 5"  
G-5149

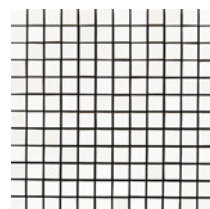

**Gallery white satinado mosaico 2,5x2,5**  
29,75 x 29,75 cm - 11.71" x 11.71"  
G-6868



**Gallery yellow pulido / satinado taco**  
7,3 x 7,3 cm - 2.87" x 2.87"  
G-5027 / 5025



**Gallery yellow pulido listelo-30**  
7,3 x 29,75 cm - 2.87" x 11.71"  
G-5075

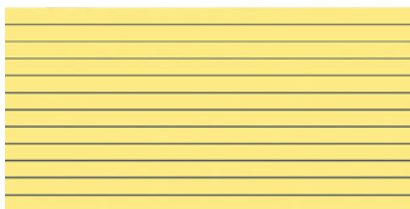

**Gallery yellow pulido preincisión 2,5x60**  
29,75 x 59,55 cm - 11.71" x 23.45"  
G-6666



**Gallery black satinado b-insert\***  
29,75 x 59,55 cm - 11.71" x 23.45"  
G-5283

**Gallery yellow satinado inserto\***  
R 12,8 cm - R 5"  
G-5149

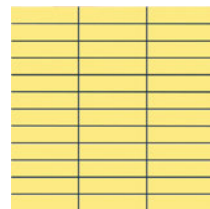

**Gallery yellow pulido mosaico 2,5x10**  
29,75 x 29,75 cm - 11.71" x 11.71"  
G-6868

**Gallery yellow pulido lista**  
3,3 x 59,55 cm - 1.38" x 23.45"  
G-5100

**Gallery yellow satinado rodapié 30**  
7,3 x 29,75 cm - 2.87" x 11.71"  
G-5081

**Gallery yellow satinado rodapié 60**  
7,3 x 59,55 cm - 2.87" x 23.45"  
G-5119

\* insert and b-insert are sold separately.  
insert y b-insert se venden por separado.

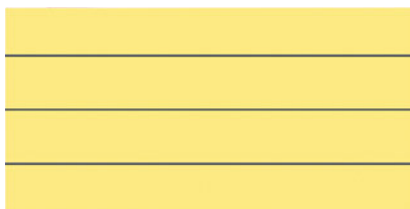

**Gallery yellow pulido preincisión 7,5x60**  
29,75 x 59,55 cm - 11.71" x 23.45"  
G-6666

STEPS.GRADINI.PELDAÑOS

SIMPLE	pulido		satinado	
	peldaño simple-30 (30x60 cm)	5345	5291	
	peldaño simple-60 (30x60 cm)	5345	5291	
	peldaño simple áng. (30x60 cm)	5375	5319	

GRADONE	pulido		satinado	
	peldaño grad-30 (30x60 cm)	5623	5603	
	peldaño grad-60 (30x60 cm) <th>5623</th> <th>5603</th> <td></td>	5623	5603	
	peldaño grad. áng (30x60 cm) <th>5691</th> <th>5647</th> <td></td>	5691	5647	

\* INFO pag. 207.

Gallery satinado

**CLASE 1**

UNE - ENV 12633

**DCOF>0.42**

ANSI A 137.1 - 2012



GUARDERIA ALOVERA  
Guadalajara. (SPAIN)  
Arch. LAUREANO RODRIGUEZ LARGACHA

# GALLERY orange

PLAIN TILES.BASE.BASES

SPECIAL PIECES.PEZZI SPECIALI.PIEZAS ESPECIALES



**Gallery orange pulido / satinado**  
29,75 x 59,55 cm - 11.71" x 23.45"  
G-6644 / 6594

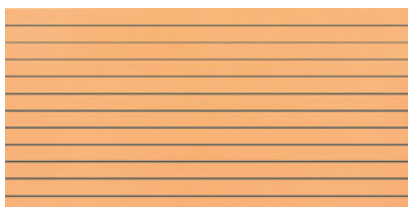

**Gallery orange pulido preincisión 2,5x60**  
29,75 x 59,55 cm - 11.71" x 23.45"  
G-6796



**Gallery orange pulido preincisión 7,5x60**  
29,75 x 59,55 cm - 11.71" x 23.45"  
G-6796

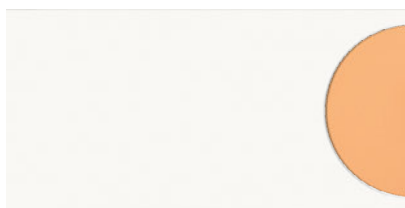

**Gallery white satinado b-insert\***  
29,75 x 59,55 cm - 11.71" x 23.45"  
G-5283



**Gallery black satinado b-insert\***  
29,75 x 59,55 cm - 11.71" x 23.45"  
G-5283

**Gallery orange satinado inserto\***  
R 12,8 cm - R 5"  
G-5243

**Gallery orange satinado inserto\***  
R 12,8 cm - R 5"  
G-5243

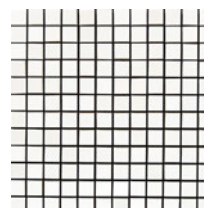

**Gallery white satinado mosaico 2,5x2,5**  
29,75 x 29,75 cm - 11.71" x 11.71"  
G-6868

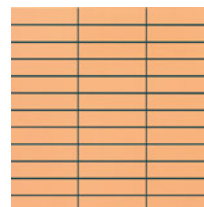

**Gallery orange pulido mosaico 2,5x10**  
29,75 x 29,75 cm - 11.71" x 11.71"  
G-6980



**Gallery orange pulido / satinado taco**  
7,3 x 7,3 cm - 2.87" x 2.87"  
G-5047 / 5043



**Gallery orange pulido listelo-30**  
7,3 x 29,75 cm - 2.87" x 11.71"  
G-5097



**Gallery orange pulido / satinado listelo**  
7,3 x 59,55 cm - 2.87" x 23.45"  
G-5155 / 5141



**Gallery orange pulido lista**  
3,3 x 59,55 cm - 1.38" x 23.45"  
G-5100



**Gallery orange satinado rodapié 30**  
7,3 x 29,75 cm - 2.87" x 11.71"  
G-5105



**Gallery orange satinado rodapié 60**  
7,3 x 59,55 cm - 2.87" x 23.45"  
G-5165

\* insert and b-insert are sold separately.  
insert y b-insert se venden por separado.

STEPS.GRADINI.PELDAÑOS

SIMPLE		pulido satinado	
		simple	áng.
	peldaño simple-30 (30x60 cm)	5471	5449
	peldaño simple-60 (30x60 cm)	5471	5449
	peldaño simple áng. (30x60 cm)	5513	5485

GRADONE		pulido satinado	
		grad-	áng.
	peldaño grad-30 (30x60 cm)	5655	5639
	peldaño grad-60 (30x60 cm)	5655	5639
	peldaño grad. áng. (30x60 cm)	5713	5701

\* INFO pag. 207

Gallery satinado

**CLASE 1**  
UNE - ENV 12633

COMPLEMENTS.COMPLEMENTI  
COMPLEMENTOS



**Byte ice / yellow / red / black lista 60\***  
1,5 x 59,55 cm - 0.59" x 23.45"  
G-5100



**Pod white / ice / yellow / orange / red / purple / blue / black lista 60\***  
1,5 x 59,55 cm - 0.59" x 23.45"  
G-5100

**Fusion natural lista 60\***  
1 x 59,55 cm - 0.39" x 23.45"  
G-5049

**Fusion graffiato lista 60**  
1,5 x 59,55 cm - 0.59" x 23.45"  
G-5069

\* recommended only for walls

GALLERY

# GALLERY lime

PLAIN TILES.BASE.BASES



**Gallery lime pulido / satinado**  
29,75 x 59,55 cm - 11.71" x 23.45"  
G-6656 / 6364

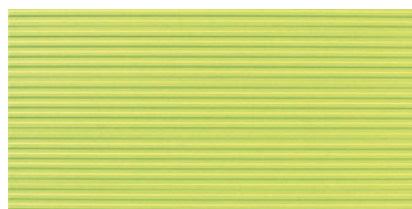

**Gallery lime righe**  
29,75 x 59,55 cm - 11.71" x 23.45"  
G-6604

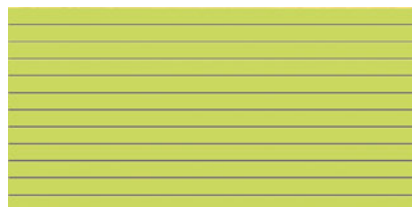

**Gallery lime pulido preincisión 2,5x60**  
29,75 x 59,55 cm - 11.71" x 23.45"  
G-6666

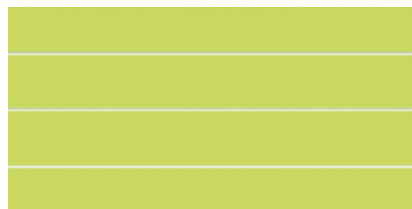

**Gallery lime pulido preincisión 7,5x60**  
29,75 x 59,55 cm - 11.71" x 23.45"  
G-6666

SPECIAL PIECES.PEZZI SPECIALI.PIEZAS ESPECIALES

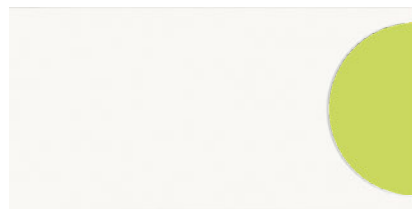

**Gallery white satinado b-insert\***  
29,75 x 59,55 cm - 11.71" x 23.45"  
G-5283

**Gallery lime satinado inserto\***  
R 12,8 cm - R 5"  
G-5149

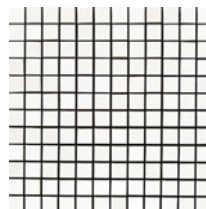

**Gallery white satinado mosaico 2,5x2,5**  
29,75 x 29,75 cm - 11.71" x 11.71"  
G-6868



**Gallery black satinado b-insert\***  
29,75 x 59,55 cm - 11.71" x 23.45"  
G-5283

**Gallery lime satinado inserto\***  
R 12,8 cm - R 5"  
G-5149

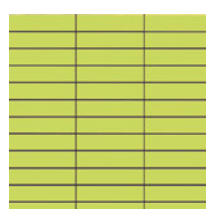

**Gallery lime pulido mosaico 2,5x10**  
29,75 x 29,75 cm - 11.71" x 11.71"  
G-6868

\* insert and b-insert are sold separately.  
insert y b-insert se venden por separado.

STEPS.GRADINI.PELDAÑOS

		pulido	satinado
SIMPLE	pedaño simple-30 (30x60 cm)	5345	5291
	pedaño simple-60 (30x60 cm)	5345	5291
	pedaño simple áng. (30x60 cm)	5375	5319
GRADONE	pedaño grad-30 (30x60 cm)	5623	5603
	pedaño grad-60 (30x60 cm)	5623	5603
	pedaño grad. áng (30x60 cm)	5691	5667

+ INFO pag. 207.



**Gallery lime pulido / satinado taco**  
7,3 x 7,3 cm - 2.87" x 2.87"  
G-5027 / 5025

**Gallery lime pulido listelo-30**  
7,3 x 29,75 cm - 2.87" x 11.71"  
G-5079



**Gallery lime pulido / satinado listelo**  
7,3 x 59,55 cm - 2.87" x 23.45"  
G-5111 / 5097



**Gallery lime pulido lista**  
3,3 x 59,55 cm - 1.38" x 23.45"  
G-5100



**Gallery lime satinado rodapié 30**  
7,3 x 29,75 cm - 2.87" x 11.71"  
G-5081



**Gallery lime satinado rodapié 60**  
7,3 x 59,55 cm - 2.87" x 23.45"  
G-5119

COMPLEMENTS.COMPLEMENTI.COMPLEMENTOS



**Byte ice / yellow / red / black lista 60\***  
1,5 x 59,55 cm - 0.59" x 23.45"  
G-5100



**Pod white / ice / yellow / orange / red / purple / blue / black lista 60\***  
1,5 x 59,55 cm - 0.59" x 23.45"  
G-5100



**Fusion natural lista 60\***  
1 x 59,55 cm - 0.39" x 23.45"  
G-5049



**Fusion graffiato lista 60**  
1,5 x 59,55 cm - 0.59" x 23.45"  
G-5069

\* recommended only for walls

Gallery satinado

**CLASE 1**  
UNE - ENV 12633

**DCOF>0.42**  
ANSI A 137.1 - 2012



GALLERY

Gallery Lime Pulido 29,75x59,55 cm

CARREFOUR SHOPPING CENTER  
L'Altet - Alicante. (SPAIN)

# GALLERY red

PLAIN TILES.BASE.BASES

SPECIAL PIECES.PEZZI SPECIALI.PIEZAS ESPECIALES



**Gallery red pulido / satinado**  
29,75 x 59,55 cm - 11.71" x 23.45"  
G-6870 / 6844

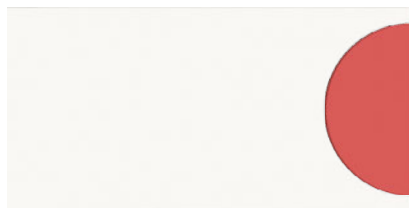

**Gallery white satinado b-insert\***  
29,75 x 59,55 cm - 11.71" x 23.45"  
G-5283

**Gallery red satinado inserto\***  
R 12,8 cm - R 5"  
G-5367

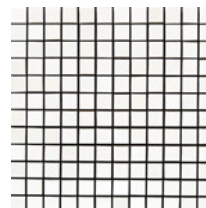

**Gallery white satinado mosaico 2,5x2,5**  
29,75 x 29,75 cm - 11.71" x 11.71"  
G-6868



**Gallery red pulido / satinado taco**  
7,3 x 7,3 cm - 2.87" x 2.87"  
G-5059 / 5061



**Gallery red pulido / satinado listelo**  
7,3 x 59,55 cm - 2.87" x 23.45"  
G-5251 / 5243



**Gallery red pulido lista**  
3,3 x 59,55 cm - 1.38" x 23.45"  
G-5100



**Gallery red satinado rodapié 30**  
7,3 x 29,75 cm - 2.87" x 11.71"  
G-5163



**Gallery red satinado rodapié 60**  
7,3 x 59,55 cm - 2.87" x 23.45"  
G-5283



**Gallery red pulido preincisión 2,5x60**  
29,75 x 59,55 cm - 11.71" x 23.45"  
G-6987



**Gallery black satinado b-insert\***  
29,75 x 59,55 cm - 11.71" x 23.45"  
G-5283

**Gallery red satinado inserto\***  
R 12,8 cm - R 5"  
G-5367

\* insert and b-insert are sold separately.  
insert y b-insert se venden por separado.

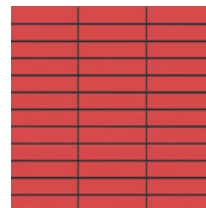

**Gallery red pulido mosaico 2,5x10**  
29,75 x 29,75 cm - 11.71" x 11.71"  
G-6996

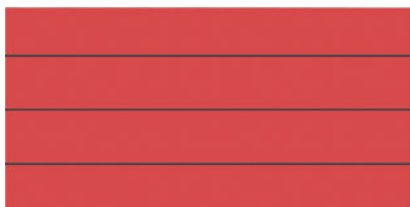

**Gallery red pulido preincisión 7,5x60**  
29,75 x 59,55 cm - 11.71" x 23.45"  
G-6987

STEPS.GRADINI.PELDAÑOS

SIMPLE	pulido satinado			
	peleñaño simple-30 (30x60 cm)	5693	5681	
	peleñaño simple-60 (30x60 cm)	5693	5681	
	peleñaño simple áng. (30x60 cm)	5701	5687	

GRADONE	pulido satinado			
	peleñaño grad-30 (30x60 cm)	5755	5749	
	peleñaño grad-60 (30x60 cm) <th>5755</th> <th>5749</th> <td></td>	5755	5749	
	peleñaño grad. áng (30x60 cm) <th>5829</th> <th>5815</th> <td></td>	5829	5815	

\* INFO pag. 207.

**Gallery satinado**

**CLASE 1**

UNE - ENV 12633

**DCOF>0.42**

ANSI A 137.1 - 2012



**ELEMENTARY SCHOOL SEIXAL**  
Seixal. (PORTUGAL)  
Arch. JOSÉ JESUITA

# GALLERY blue

PLAIN TILES.BASE.BASES



**Gallery blue pulido / satinado**  
29,75 x 59,55 cm - 11.71" x 23.45"  
G-6558 / 6506

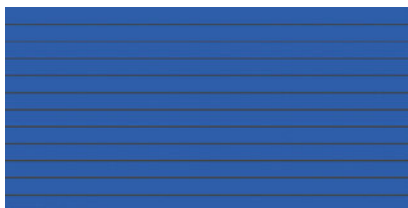

**Gallery blue pulido preincisión 2,5x60**  
29,75 x 59,55 cm - 11.71" x 23.45"  
G-6790

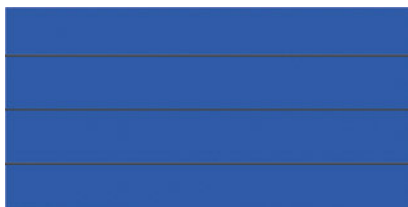

**Gallery blue pulido preincisión 7,5x60**  
29,75 x 59,55 cm - 11.71" x 23.45"  
G-6790

SPECIAL PIECES.PEZZI SPECIALI.PIEZAS ESPECIALES

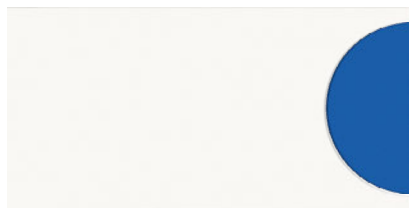

**Gallery white satinado b-insert\***  
29,75 x 59,55 cm - 11.71" x 23.45"  
G-5283



**Gallery black satinado b-insert\***  
29,75 x 59,55 cm - 11.71" x 23.45"  
G-5283

\* insert and b-insert are sold separately.  
insert y b-insert se venden por separado.

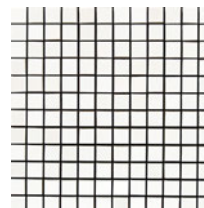

**Gallery white satinado mosaico 2,5x2,5**  
29,75 x 29,75 cm - 11.71" x 11.71"  
G-6868

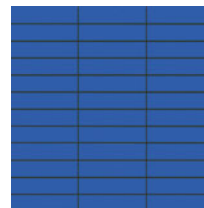

**Gallery blue pulido mosaico 2,5x10**  
29,75 x 29,75 cm - 11.71" x 11.71"  
G-6960



**Gallery blue pulido / satinado taco**  
7,3 x 7,3 cm - 2.87" x 2.87"  
G-5041 / 5039



**Gallery blue pulido / satinado listelo**  
7,3 x 59,55 cm - 2.87" x 23.45"  
G-5135 / 5131



**Gallery blue pulido lista**  
3,3 x 59,55 cm - 1.38" x 23.45"  
G-5100



**Gallery blue satinado rodapié 30**  
7,3 x 29,75 cm - 2.87" x 11.71"  
G-5089



**Gallery blue satinado rodapié 60**  
7,3 x 59,55 cm - 2.87" x 23.45"  
G-5141

STEPS.GRADINI.PELDAÑOS

SIMPLE		pulido satinado	
		30x60 cm	30x60 cm
	pedaño simple-30 (30x60 cm)	5445	5401
	pedaño simple-60 (30x60 cm)	5445	5401
	pedaño simple áng. (30x60 cm)	5445	5431

GRADONE		pulido satinado	
		30x60 cm	30x60 cm
	pedaño grad-30 (30x60 cm)	5623	5603
	pedaño grad-60 (30x60 cm)	5623	5603
	pedaño grad. áng. (30x60 cm)	5691	5667

\* INFO pag. 207

Gallery satinado

**CLASE 1**

UNE - ENV 12633

**DCOF>0.42**

ANSI A 137.1 - 2012

COMPLEMENTS.COMPLEMENTI.  
COMPLEMENTOS



**Byte ice / yellow / red / black lista 60\***  
1,5 x 59,55 cm - 0.59" x 23.45"  
G-5100



**Pod white / ice / yellow / orange / red / purple / blue / black lista 60\***  
1,5 x 59,55 cm - 0.59" x 23.45"  
G-5100



**Fusion natural lista 60\***  
1 x 59,55 cm - 0.39" x 23.45"  
G-5049



**Fusion graffiato lista 60**  
1,5 x 59,55 cm - 0.59" x 23.45"  
G-5069

\* recommended only for walls

GALLERY

# GALLERY black

PLAIN TILES.BASE.BASES

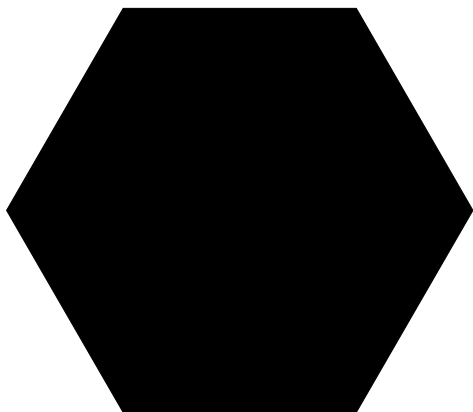

**Gallery black satinado hexagonal**

59,55 x 51,57 cm - 23.45" x 20.31"

G-6558

3 mm joint are recommended for hexagonal sizes.  
para formatos hexagonales se recomienda una junta de separación de 3 mm.



**Gallery black pulido / satinado**

29,75 x 59,55 cm - 11.71" x 23.45"

G-6450 / 6352



**Gallery black righe**

29,75 x 59,55 cm - 11.71" x 23.45"

G-6392

SPECIAL PIECES.PEZZI SPECIALI.PIEZAS ESPECIALES



**Gallery black pulido preincisión 2,5x60**

29,75 x 59,55 cm - 11.71" x 23.45"

G-6666

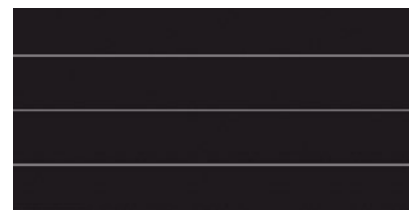

**Gallery black pulido preincisión 7,5x60**

29,75 x 59,55 cm - 11.71" x 23.45"

G-6666



**Gallery black pulido / satinado**

59,55 x 59,55 cm - 23.45" x 23.45"

G-6506 / 6452

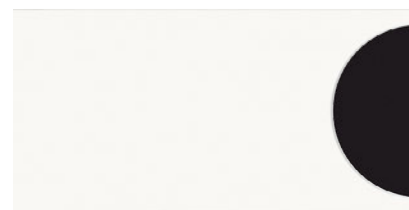

**Gallery white satinado b-insert\***

29,75 x 59,55 cm - 11.71" x 23.45"

G-5283

**Gallery black satinado inserto\***

R 12,8 cm - R 5"

G-5149



**Gallery black satinado b-insert\***

29,75 x 59,55 cm - 11.71" x 23.45"

G-5283

**Gallery white satinado inserto\***

R 12,8 cm - R 5"

G-5149

\* insert and b-insert are sold separately. /  
insert y b-insert se venden por separado.

Gallery satinado

CLASE 1

UNE - ENV 12633

DCOF>0.42

ANSI A 137.1 - 2012

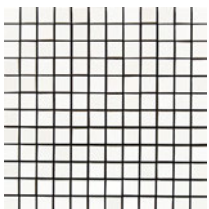

**Gallery white satinado  
mosaico 2,5x2,5**  
29,75 x 29,75 cm - 11.71" x 11.71"  
G-6868

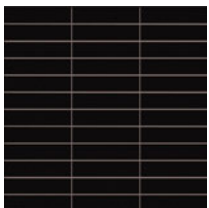

**Gallery black pulido  
mosaico 2,5x10**  
29,75 x 29,75 cm - 11.71" x 11.71"  
G-6858



**Gallery black  
pulido / satinado taco**  
7,3 x 7,3 cm - 2.87" x 2.87"  
G-5027 / 5025



**Gallery black pulido / satinado listelo**  
7,3 x 59,55 cm - 2.87" x 23.45"  
G-5109 / 5095



**Gallery black pulido lista**  
3,3 x 59,55 cm - 1.38" x 23.45"  
G-5100



**Gallery black satinado rodapié 30**  
7,3 x 29,75 cm - 2.87" x 11.71"  
G-5081



**Gallery black pulido / satinado rodapié 60**  
7,3 x 59,55 cm - 2.87" x 23.45"  
G-5125 / 5117

## STEPS. GRADINI.PELDAÑOS

SIMPLE			pulido satinado	
	peldaño simple-30	(30x60 cm)	5337	5281
	peldaño simple-60	(30x60 cm)	5337	5281
	peldaño simple áng.	(30x60 cm)	5367	5367
	peldaño simple-60	(60x60 cm)	5501	5501
	peldaño simple áng.	(60x60 cm)	5515	5515

GRADONE			pulido satinado	
	peldaño grad-30	(30x60 cm)	5623	5603
	peldaño grad-60	(30x60 cm)	5623	5603
	peldaño grad. áng.	(30x60 cm)	5691	5667
	peldaño grad-60	(60x60 cm)	5609	5609
	peldaño simple áng.	(60x60 cm)	5655	5655

\* INFO pag 207

## COMPLEMENTS.COMPLEMENTI. COMPLEMENTOS



**Byte ice / yellow / red / black lista 60\***  
1,5 x 59,55 cm - 0.59" x 23.45"  
G-5100



**Pod white / ice / yellow / orange / red /  
purple / blue / black lista 60\***  
1,5 x 59,55 cm - 0.59" x 23.45"  
G-5100

**Fusion natural lista 60\***  
1 x 59,55 cm - 0.39" x 23.45"  
G-5049

**Fusion graffiato lista 60**  
1,5 x 59,55 cm - 0.59" x 23.45"  
G-5069















\* recommended only for walls



GALLERY

NANDOS RESTAURANT  
London. (U.K.)

# TECHNICAL CHARACTERISTICS. CARATTERISTICHE TECNICHE. CARACTERÍSTICAS TÉCNICAS

MEASUREMENTS AND SURFACES APPEARANCE / DIMENSIONI E ASPETTO SUPERFICIALE / MEDIDAS Y ASPECTO SUPERFICIAL / MASSEN UND AUSSEHEN DER OBERFLÄCHE		STANDARD TEST METHOD METODO DELLA NORMA METODO DE ENSAYO STANDARD TEST METHOD	STANDARD PRESCRIBED VALUES VALORE PRESCRITTO VALORES STANDARD NORMA STANDARDWERTE	GALLERY collection *
 <b>Length and width.</b> <i>Lunghezza e larghezza.</i> Longitud y anchura. Länge und Breite		ISO 10545-2	± 0,6% max.	± 0,1%
 <b>Thickness.</b> <i>Spessore.</i> Grosor. Stärke		ISO 10545-2	± 5% max.	± 2%
 <b>90° Orthogonality.</b> <i>Ortogonalità.</i> Ortogonalidad. Rechtwinkligkeit		ISO 10545-2	± 0,6% max.	± 0,2%
 <b>Straightness of sides.</b> <i>Rettilinearità dei lati.</i> Rectitud de lados. Kantengeradigkeit		ISO 10545-2	± 0,5% max.	± 0,2%
 <b>Surfaces flatness.</b> <i>Planarità.</i> Planitud. Ebenföchigkeit		ISO 10545-2	± 0,5% max.	± 0,2%
PHYSICAL PROPERTIES / PROPIETÀ FISICHE / PROPIEADADES FÍSICAS / PHYSIKALISCHE EIGENSCHAFTEN				
 <b>Water absorption.</b> <i>Assorbimento d'acqua.</i> Absorción de agua. Wasseraufnahme		ISO 10545-3	≤ 0,5%	0,1%
 <b>Breaking strength, in N.</b> <i>Carico di rottura, en N.</i> Carga de rotura, en N. Bruchlast, in N	thickness>7,5 mm spessore>7,5 mm grosor>7,5 mm	ISO 10545-4	≥ 1300 N	2200 N*
 <b>Modulus of rupture.</b> <i>Resistenza alla flessione.</i> Resistencia a la flexión. Biegefestigkeit		ISO 10545-4	≥ 35 N/mm <sup>2</sup>	52 N/mm <sup>2</sup> *
 <b>Resistance to deep abrasion.</b> <i>Resistenza all'abrasione profonda.</i> Resistencia a la abrasión profunda. Tiefverschleissbeständigkeit		ISO 10545-6	≤ 175 mm <sup>3</sup>	121 mm <sup>3</sup> ***
 <b>Resistance to thermal shock.</b> <i>Resistenza agli sbalzi termici.</i> Resistencia al choque térmico. Temperaturwechselbeständigkeit		ISO 10545-9	No surface defects should be visible <i>Non deve presentare difetti visibili</i> No debe presentar defectos superficiales visibles	Resistant. Resistente. Resistente
 <b>Frost resistance.</b> <i>Resistenza al gelo.</i> Resistencia a la helada. Frostbeständigkeit		ISO 10545-12	No surface defects or cracks should be visible <i>Non deve presentare difetti visibili</i> No debe presentar defectos ni grietas superficiales visibles	Frost Resistant <i>Antighiaccio</i> Resistente a la Helada
 <b>Coefficient of friction.</b> <i>Resistenza allo scivolamento.</i> Coeficiente de fricción. Rutschfestigkeit		UNE - ENV 12633 ASTM C 1028-96	WET TEST/ENSAYO EN HÚMEDO DRY TEST/ENSAYO EN SECO S.C.O.F. >0.60 (for horizontal surfaces)	Clase I ** Clase 3*** SCOF: 0.70 - 0.79 **** DCOF - ANSIA 137.1-2012 > 0.42
 <b>Colour resistance to light.</b> <i>Resistenza dei colori alla luce.</i> Resistencia del color a la luz. Lichtbeständigkeit der Farben		DIN 51094	There should be no colour variations <i>Non deve presentare sbalzi visibili</i> No debe presentar variaciones de color	No alterations to colour and shine <i>Non deve presentare alterazioni di colori e lucentezza</i> No debe presentar variaciones de color y brillo
CHEMICAL PROPERTIES / PROPIETÀ CHIMICHE / PROPIEADADES QUÍMICAS / CHEMISCHEN EIGENSCHAFTEN				
 <b>Chemical resistance.</b> <i>Resistenza agli agenti chimici.</i> Resistencia química. Chemikalienbeständigkeit		ISO 10545-13	Resistance to household cleaning products and swimmingpools salts. <i>Resistencia a productos domésticos y sales para piscinas</i>	Min. UB
 <b>Resistance to staining.</b> <i>Resistenza alle macchie.</i> Resistencia a las manchas. Fleckenbeständigkeit		ISO 10545-14	≥ 3	4*** - 5

\*The Land values are the average of different production consignments. For further detail information, please check with our commercial network. / I valori dichiarati sono ottenuti da una media di prove effettuate su diverse produzioni. Per avere informazioni dettagliate consultare la rete commerciale / Los valores declarados son el promedio obtenido a través de ensayos de diferentes producciones. Para la obtención de una información detallada consultar a la red comercial.

\*\* Tested in satinado finishes. Test realized in internal laboratory. Provare realizzato in laboratorio interno. Ensayo realizado en laboratorio interno. Gallery hexagonal white satinado (clase I).

\*\*\* Test realized in Gallery white pulido. Provare realizzato in Gallery white pulido. Ensayo realizado en Gallery white pulido. (lote 4-11-05)

\*\*\*\* Dry Test, according to document DA DB-SUA/3 (Código Técnico de la Edificación) M° de Fomento. Average test result value, on May 2012. Ensayo realizado, según documento DA DB-SUA/3 (Código Técnico de la Edificación) M° de Fomento, valor medio a fecha Mayo 2012.

\*\*\*\*\* SMITH-EMERY laboratories. SCOF: Static Coefficient of Friction. Tested in satinado: 0.66 (wet) , 0.86 (dry). (lote 03-11-06)



GALLERY

Gallery Lime - Orange - Blue - Red - Yellow Satinado 29,75x59,55 cm  
Pietra Serena Moss Natural 29,75x59,55 cm

CASA JUVENTUD DE AUTOL  
Logroño. (SPAIN)  
Arch. MD. ARQUITECTURA-URBANISMO, S.L.  
Juan Carlos Merino Álvarez

# GALLERY SLIM



## COLOURS



VIENNA INTERNATIONAL SCHOOL  
Vienna. (AUSTRIA)



\* Gallery slim white. Content of recycled material. Contenido de material reciclado.

## FORMATS.FORMATI.FORMATOS



30X60  
29,75x59,55 cm - 11.71"x23.45"



30X90 natural  
29,75x89,46 cm - 11.71"x35.22"



30X90 hexagon  
29,75x89,46 cm - 11.71"x35.22"



30X90 square  
29,75x89,46 cm - 11.71"x35.22"

## SPECIAL PIECES.PEZZI SPECIALI.PIEZAS ESPECIALES



30X30 mosaico 2,5x2,5  
29,75x29,75 cm - 11.71"x11.71"



30X30 mosaico multicolor 2,5x2,5  
29,75x29,75 cm - 11.71"x11.71"



30X30 mosaico 10x10  
29,75x29,75 cm - 11.71"x11.71"

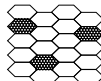

30X30 mosaico hexagonal 6x7,5  
29,75x29,75 cm - 11.71"x11.71"

## THICKNESS.SPESORE.ESPESORES

 0,48 cm approx. / 0.19" approx.

## COLOURS COLORI COLORES



white



orange



lime



red



blue



black

## FINISHES FINITURI ACABADOS



natural

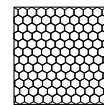

hexagon

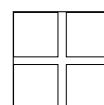

square

# GALLERY SLIM white

PLAIN TILES.BASE.BASES

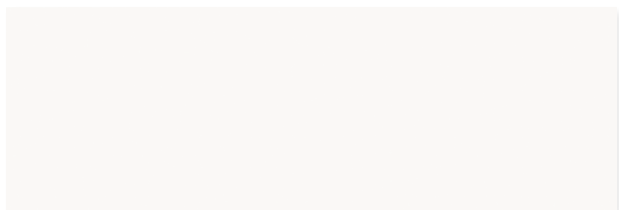

**Gallery slim white natural**  
29,75 x 89,46 cm - 11.71" x 35.22"  
G-6224

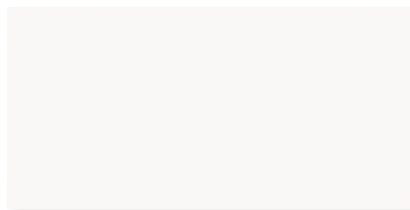

**Gallery slim white**  
29,75 x 59,55 cm - 11.71" x 23.45"  
G-6218

SPECIAL PIECES.PEZZI SPECIALI.  
PIEZAS ESPECIALES

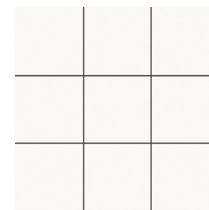

**Gallery slim white  
mosaico 10x10**  
29,75 x 29,75 cm - 11.71" x 11.71"  
G-6666

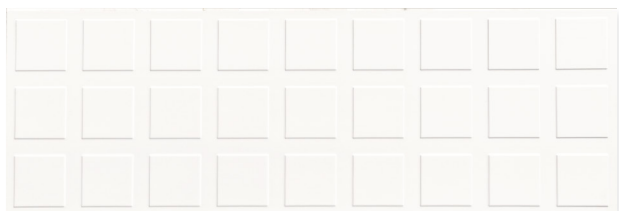

**Gallery slim white square**  
29,75 x 89,46 cm - 11.71" x 35.22"  
G-6246

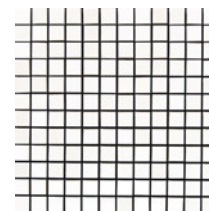

**Gallery slim white  
mosaico 2,5x2,5**  
29,75 x 29,75 cm - 11.71" x 11.71"  
G-6756

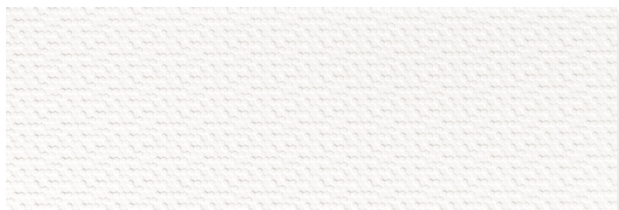

**Gallery slim white hexagon**  
29,75 x 89,46 cm - 11.71" x 35.22"  
G-6246



**Gallery slim white  
mosaico hexagonal 6x7,5\***  
29,75 x 29,75 cm - 11.71" x 11.71"  
G-6796

COMPLEMENTS.COMPLEMENTI.COMPLEMENTOS

**Fusion graffiato lista 90**  
1,5 x 89,46 cm - 0.59" x 35.22"



G-5091

**Fusion graffiato lista 60**  
1,5 x 59,55 cm - 0.59" x 23.45"



G-5069

**Fusion natural lista 60**  
1 x 59,55 cm - 0.39" x 23.45"



G-5049

\* the three hexagonal tesserae change pattern randomly.  
las tres teselas hexagon cambian de posición aleatoriamente.



GALLERY SLIM

Gallery Slim White Hexagon 29,75x89,46 cm

# GALLERY SLIM black

PLAIN TILES.BASE.BASES



**Gallery slim black natural**  
29,75 x 89,46 cm - 11.71" x 35.22"  
G-6224



**Gallery slim black**  
29,75 x 59,55 cm - 11.71" x 23.45"  
G-6240

SPECIAL PIECES.PEZZI SPECIALI.  
PIEZAS ESPECIALES

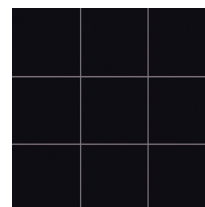

**Gallery slim black  
mosaico 10x10**  
29,75 x 29,75 cm - 11.71" x 11.71"  
G-6666

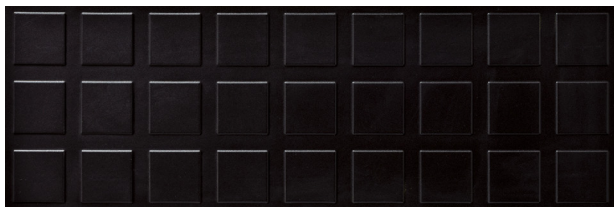

**Gallery slim black square**  
29,75 x 89,46 cm - 11.71" x 35.22"  
G-6246

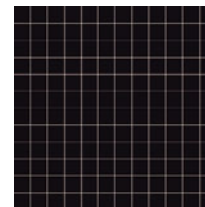

**Gallery slim black  
mosaico 2,5x2,5**  
29,75 x 29,75 cm - 11.71" x 11.71"  
G-6756



**Gallery slim black hexagon**  
29,75 x 89,46 cm - 11.71" x 35.22"  
G-6246



**Gallery slim black  
mosaico hexagonal 6x7,5\***  
29,75 x 29,75 cm - 11.71" x 11.71"  
G-6796

COMPLEMENTS.COMPLEMENTI.COMPLEMENTOS

**Fusion graffiato lista 90**  
1,5 x 89,46 cm - 0.59" x 35.22"



G-5091

**Fusion graffiato lista 60**  
1,5 x 59,55 cm - 0.59" x 23.45"



G-5069

**Fusion natural lista 60**  
1 x 59,55 cm - 0.39" x 23.45"



G-5049

\* the three hexagonal tesserae change pattern randomly.  
las tres teselas hexagon cambian de posición aleatoriamente.



GALLERY SLIM

wall: Gallery Slim White Square\_Black Natural 29,75x89,46 cm floor: Gallery White - Black Satinado 59,55x59,55 cm

# GALLERY SLIM lime - orange - red - blue

## PLAIN TILES.BASE.BASES



**Gallery slim lime**  
29,75 x 59,55 cm - 11.71" x 23.45"  
G-6218



**Gallery slim orange**  
29,75 x 59,55 cm - 11.71" x 23.45"  
G-6240



**Gallery slim red**  
29,75 x 59,55 cm - 11.71" x 23.45"  
G-6240



**Gallery slim blue**  
29,75 x 59,55 cm - 11.71" x 23.45"  
G-6240

## SPECIAL PIECES.PEZZI SPECIALI. PIEZAS ESPECIALES

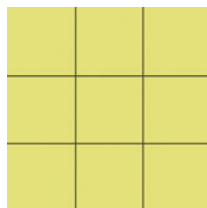

**Gallery slim lime  
mosaico 10x10**  
29,75 x 29,75 cm - 11.71" x 11.71"  
G-6666

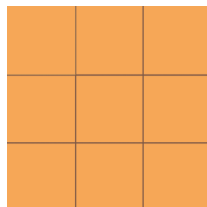

**Gallery slim orange  
mosaico 10x10**  
29,75 x 29,75 cm - 11.71" x 11.71"  
G-6666

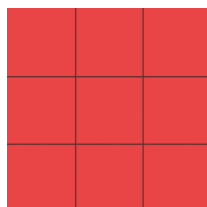

**Gallery slim red  
mosaico 10x10**  
29,75 x 29,75 cm - 11.71" x 11.71"  
G-6666



**Gallery slim blue  
mosaico 10x10**  
29,75 x 29,75 cm - 11.71" x 11.71"  
G-6666

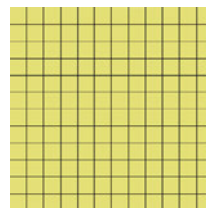

**Gallery slim lime  
mosaico 2,5x2,5**  
29,75 x 29,75 cm - 11.71" x 11.71"  
G-6756

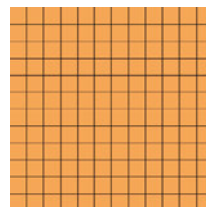

**Gallery slim orange  
mosaico 2,5x2,5**  
29,75 x 29,75 cm - 11.71" x 11.71"  
G-6756

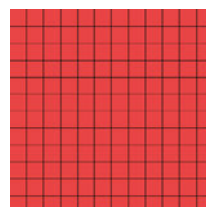

**Gallery slim red  
mosaico 2,5x2,5**  
29,75 x 29,75 cm - 11.71" x 11.71"  
G-6756

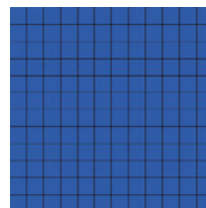

**Gallery slim blue  
mosaico 2,5x2,5**  
29,75 x 29,75 cm - 11.71" x 11.71"  
G-6756

## COMPLEMENTS.COMPLEMENTI. COMPLEMENTOS

**Fusion graffiato lista 60**  
1,5 x 59,55 cm - 0.59" x 23.45"



G-5069

**Fusion natural lista 60**  
1 x 59,55 cm - 0.39" x 23.45"



G-5049

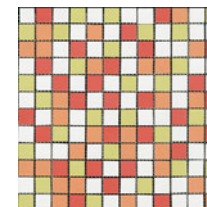

**Gallery slim red  
mosaico multicolor 2,5x2,5**  
29,75 x 29,75 cm - 11.71" x 11.71"  
G-6756

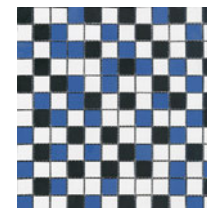













**Gallery slim blue  
mosaico multicolor 2,5x2,5**  
29,75 x 29,75 cm - 11.71" x 11.71"  
G-6756



GALLERY SLIM

Gallery Slim Lime - White - Black 29,75x59,55 cm

# TECHNICAL CHARACTERISTICS. CARATTERISTICHE TECNICHE. CARACTERÍSTICAS TÉCNICAS

MEASUREMENTS AND SURFACES APPEARANCE / DIMENSIONI E ASPETTO SUPERFICIALE / MEDIDAS Y ASPECTO SUPERFICIAL / MASSES UND AUSSEHEN DER OBERFLÄCHE		STANDARD TEST METHOD METODO DELLA NORMA METODO DE ENSAYO STANDARD TEST METHOD	STANDARD PRESCRIBED VALUES VALORE PRESCRITTO VALORES STANDARD NORMA STANDARDWERTE	<b>Gallery Slim</b> *
 <b>Length and width.</b> <i>Lunghezza e larghezza.</i> Longitud y anchura. Länge und Breite		ISO 10545-2	± 0,6% max.	± 0,1%
 <b>Orthogonality.</b> <i>Ortogonalità.</i> Ortogonalidad. Rechtwinkligkeit		ISO 10545-2	± 0,6% max.	± 0,2%
 <b>Straightness of sides.</b> <i>Rettilinearità dei lati.</i> Rectitud de lados. Kantengeradigkeit		ISO 10545-2	± 0,5% max.	± 0,2%
 <b>Surfaces flatness.</b> <i>Planarità.</i> Planitud. Ebenflächigkeit		ISO 10545-2	± 0,5% max.	± 0,2%
PHYSICAL PROPERTIES / PROPIETÀ FISICHE / PROPIEIDADES FÍSICAS / PHYSIKALISCHE EIGENSCHAFTEN				
 <b>Water absorption.</b> <i>Assorbimento d'acqua.</i> Absorción de agua. Wasseraufnahme		ISO 10545-3	≤ 0,5%	< 0,1%
 <b>Breaking strength, in N.</b> <i>Carico di rottura, en N.</i> Carga de rotura, en N. Bruchlast, in N	thickness>7,5 mm spessore>7,5 mm grösor>7,5 mm	ISO 10545-4	≥ 700 N	Available Method * Metodo Disponibile Metodo Disponible
 <b>Modulus of rupture.</b> <i>Resistenza alla flessione.</i> Resistencia a la flexión. Biegefestigkeit		ISO 10545-4	≥ 35 N/mm <sup>2</sup>	>40 N/mm <sup>2</sup> *
 <b>Resistance to thermal shock.</b> <i>Resistenza agli sbalzi termici.</i> Resistencia al choque térmico. Temperaturwechselbeständigkeit		ISO 10545-9	No surface defects should be visible Non deve presentare difetti visibili No debe presentar defectos superficiales visibles	Resistant. Resistente. Resistente
 <b>Crazing resistance.</b> <i>Resistenza agli fessurazione.</i> Resistencia al cuarteo. Rißbeständigkeit		ISO 10545-11	No surface defects or cracks should be visible Non deve presentare difetti visibili No debe presentar defectos ni grietas superficiales visibles	Resistant. Resistente. Resistente
 <b>Frost resistance.</b> <i>Resistenza al gelo.</i> Resistencia a la helada. Frostbeständigkeit		ISO 10545-12	No surface defects or cracks should be visible Non deve presentare difetti visibili No debe presentar defectos ni grietas superficiales visibles	Frost Resistant Antighiaccio Resistente a la Helada
 <b>Coefficient of friction.</b> <i>Resistenza allo scivolamento.</i> Coeficiente de fricción. Rutschfestigkeit		DIN 51130		Available Method Metodo Disponibile Metodo Disponible
 <b>Colour resistance to light.</b> <i>Resistenza dei colori alla luce.</i> Resistencia del color a la luz. Lichtbeständigkeit der Farben		DIN 51094	There should be no colour variations Non deve presentare difetti visibili No debe presentar variaciones de color	No alterations to colour and shine Non deve presentare alterazioni di colori e lucentezza No debe presentar variaciones de color y brillo
CHEMICAL PROPERTIES / PROPIETÀ CHIMICHE / PROPIEIDADES QUÍMICAS / CHEMISCHEN EIGENSCHAFTEN				
 <b>Chemical resistance.</b> <i>Resistenza agli agenti chimici.</i> Resistencia química. Chemikalienbeständigkeit		ISO 10545-13	Resistance to household cleaning products and swimmingpools salts. Resistencia a productos domésticos y sales para piscinas	Min. GB
 <b>Resistance to staining.</b> <i>Resistenza alle macchie.</i> Resistencia a las manchas. Fleckenbeständigkeit		ISO 10545-14	≥ 3	5 *

\*The Land values are the average of different production consignments. For further detail information, please check with our commercial network. /  
I valori dichiarati sono ottenuti da una media di prove effettuate su diverse produzioni. Per avere informazioni dettagliate consultare la rete commerciale /  
Los valores declarados son el promedio obtenido a través de ensayos de diferentes producciones. Para la obtención de una información detallada consultar a la red comercial.

## ADVANTAGES. VANTAGGI. VENTAJAS

- Time. *Tempo.* Tiempo
- Money. *Denaro.* Dinero
- Hygiene. *Igiene.* Higiene
- Ecologic. *Ecologia.* Ecología
- Technology. *Tecnologia.* Tecnología

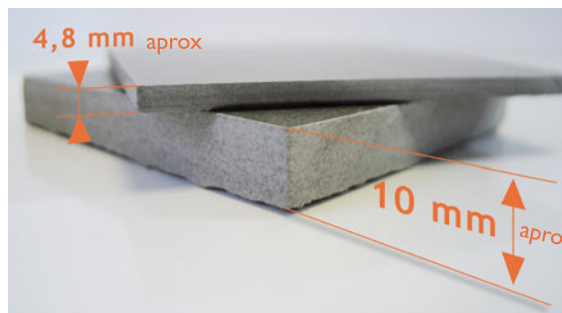

\* Recommended only for wall. /  
solo recomendado como revestimiento.



Gallery Slim White 29,75x59,55 cm

MEDITERRÁNEO HOTEL  
Roses, Girona. (SPAIN)  
Int. Design. LAIA RISQUES

GALLERY SLIM

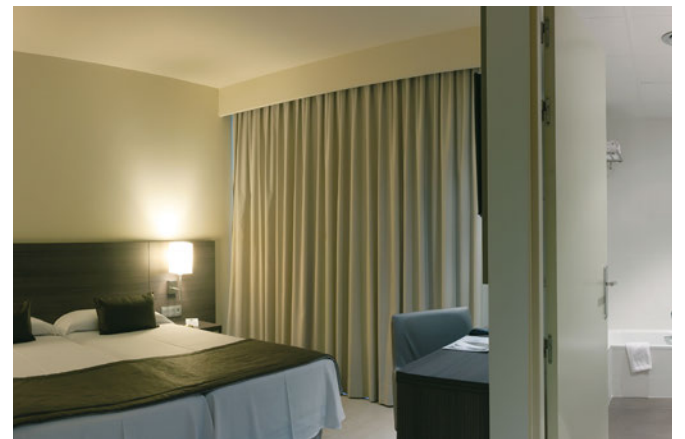

# GALLERY WALL



## COLOURS



PRIMARY SCHOOL.  
Castellón. (SPAIN)  
Arch. NACHO CARBÓ / RAFAEL CULLA



PRIMARY SCHOOL.  
Jaén. (SPAIN)  
Arch. JAVIER RUEDA MENA

\* Gallery wall brillo. Content of recycled material. Contenido de material reciclado.

FORMATS.FORMATI.FORMATOS



**30X90**  
29,75x89,46 cm - 11.71"x35.22"



**30X60**  
29,75x59,55 cm - 11.71"x23.45"



**15X90**  
14,70x89,46 cm - 5.79"x35.22"

SPECIAL PIECES.PEZZI SPECIALI.PIEZAS ESPECIALES

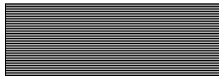

**30X90 rigato**  
29,75x89,46 cm - 11.71"x35.22"



**1,5X60 corner**  
1,5x59,55 cm - 0.59"x23.45"



**1,5X30 corner**  
1,5x29,75 cm - 0.59"x11.71"

\* Recommended only for wall. /  
sólo recomendado como revestimiento.

THICKNESS.SPESSORE.ESPESORES

≡ 1,14 cm / 0.45" approx.  
≡ 1,03 cm / 0.40" approx.

30x90 cm / 15x90 cm FORMATS  
30x60 cm FORMAT

COLOURS  
COLORI  
COLORES

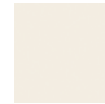

**white**



**orange**



**lime**



**red**



**blue**



**black**

FINISHES  
FINITURI  
ACABADOS

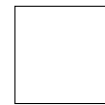

**mate**



**brillo**

# GALLERY WALL **white**\*

PLAIN TILES.BASE.BASES

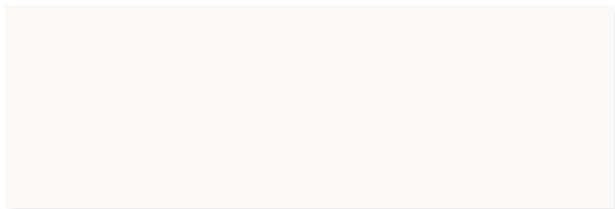

**Gallery wall white brillo / mate**  
29,75 x 89,46 cm - 11.71" x 35.22"  
G-6240 / 6240



**Gallery wall white brillo / mate**  
14,70 x 89,46 cm - 5.79" x 35.22"  
G-6284 / 6284

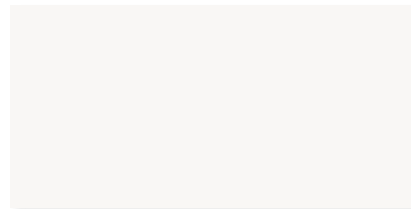

**Gallery wall white brillo**  
29,75 x 59,55 cm - 11.71" x 23.45"  
G-6208



**Gallery white brillo / mate corner 60**  
1,5 x 59,55 cm - 0.59" x 23.45"  
G-5155 / 5155



**Gallery white brillo / mate corner 30**  
1,5 x 29,75 cm - 0.59" x 11.71"  
G-5085 / 5085

## SPECIAL PIECES.PEZZI SPECIALI.PIEZAS ESPECIALES



**Gallery wall white rigato mate**  
29,75 x 89,46 cm - 11.71" x 35.22"  
G-6284



**Byte white / ice / yellow / orange / red / purple / blue / grey / moss / black lista 90**  
2 x 89,46 cm - 0.79" x 35.22"  
G-5173



**Fusion graffiato lista 90**  
1,5 x 89,46 cm - 0.59" x 35.22"  
G-5091



**Byte ice / yellow / red / black lista 60**  
1,5 x 59,55 cm - 0.59" x 23.45"  
G-5100



**Fusion natural lista 60**  
1 x 59,55 cm - 0.39" x 23.45"  
G-5049



**Fusion graffiato lista 60**  
1,5 x 59,55 cm - 0.59" x 23.45"  
G-5069



**Pod white / ice / yellow / orange / red / purple / blue / black lista 60**  
1,5 x 59,55 cm - 0.59" x 23.45"  
G-5100

## FLOOR TILES. PAVIMENTO.PAVIMENTO

FORMATS.FORMATI.FORMATOS

30 x 60 cm

COLOURS.COLORI.COLORES



FINISHES.FINITURE.ACABADOS

putido  
satinado  
rigue

See floor tiles collection on page 170.  
Ver colección completa de pavimento  
en página 170.

\* Recommended only for wall. /  
sólo recomendado como revestimiento.

# GALLERY WALL lime\*

PLAIN TILES.BASE.BASES

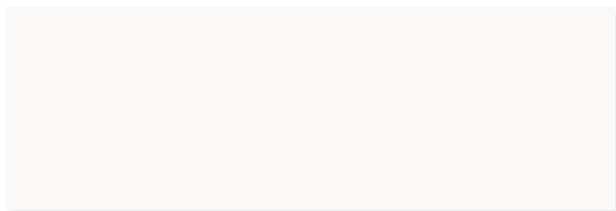

**Gallery wall white brillo / mate**  
29,75 x 89,46 cm - 11.71" x 35.22"  
G-6240 / 6240



**Gallery wall lime mate**  
29,75 x 89,46 cm - 11.71" x 35.22"  
G-6258



**Gallery wall lime mate**  
14,70 x 89,46 cm - 5.79" x 35.22"  
G-6300

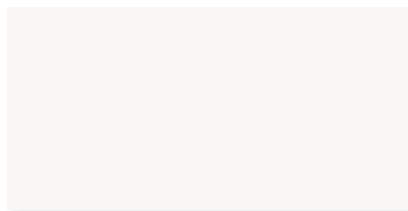

**Gallery wall white brillo**  
29,75 x 59,55 cm - 11.71" x 23.45"  
G-6208 / 6208



**Gallery wall lime brillo**  
29,75 x 59,55 cm - 11.71" x 23.45"  
G-6240



**Gallery lime brillo corner 60**  
1,5 x 59,55 cm - 0.59" x 23.45"  
G-5155



**Gallery white brillo / mate corner 30**  
1,5 x 29,75 cm - 0.59" x 11.71"  
G-5085 / 5085



**Gallery lime brillo / mate corner 30**  
1,5 x 29,75 cm - 0.59" x 11.71"  
G-5085 / 5085

## SPECIAL PIECES.PEZZI SPECIALI.PIEZAS ESPECIALES

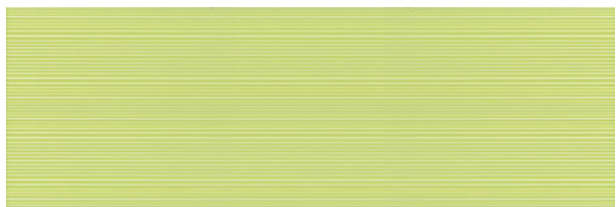

**Gallery wall lime rigato mate**  
29,75 x 89,46 cm - 11.71" x 35.22"  
G-6300



**Byte yellow lista 90**  
2 x 89,46 cm - 0.79" x 35.22"  
G-5173



**Fusion graffiato lista 90**  
1,5 x 89,46 cm - 0.59" x 35.22"  
G-5091



**Pod yellow lista 60**  
1,5 x 59,55 cm - 0.59" x 23.45"  
G-5100



**Fusion natural lista 60**  
1 x 59,55 cm - 0.39" x 23.45"  
G-5049



**Fusion graffiato lista 60**  
1,5 x 59,55 cm - 0.59" x 23.45"  
G-5069

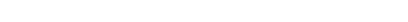

**Byte ice / yellow / red / black lista 60**  
1,5 x 59,55 cm - 0.59" x 23.45"  
G-5100



**Steel corner**  
1 x 250 cm - 0.39" x 98.42"  
G-5503

\* Recommended only for wall. / sólo recomendado como revestimiento.

GALLERY WALL

## FLOOR TILES. PAVIMENTO.PAVIMENTO

FORMATS.FORMATI.FORMATOS

30 x 60 cm

COLOURS.COLORI.COLORES



FINISHES.FINITURE.ACABADOS

pulido  
satinado  
rigue

See floor tiles collection on page 170.  
Ver colección completa de pavimento en página 170.

# GALLERY WALL red\*

PLAIN TILES.BASE.BASES

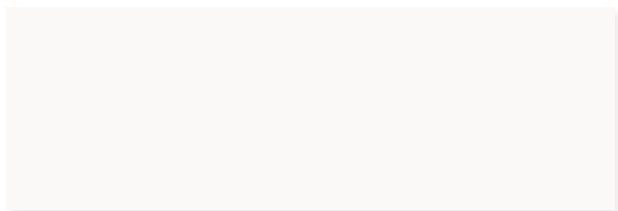

**Gallery wall white brillo / mate**  
29,75 x 89,46 cm - 11.71" x 35.22"  
G-6240 / 6240



**Gallery wall red mate**  
29,75 x 89,46 cm - 11.71" x 35.22"  
G-6270



**Gallery wall red mate**  
14,70 x 89,46 cm - 5.79" x 35.22"  
G-6312

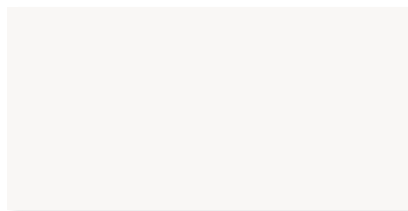

**Gallery wall white brillo**  
29,75 x 59,55 cm - 11.71" x 23.45"  
G-6208 / 6208



**Gallery wall red brillo**  
29,75 x 59,55 cm - 11.71" x 23.45"  
G-6254



**Gallery red brillo corner 60**  
1,5 x 59,55 cm - 0.59" x 23.45"  
G-5155



**Gallery white brillo / mate corner 30**  
1,5 x 29,75 cm - 0.59" x 11.71"  
G-5085 / 5085



**Gallery red brillo / mate corner 30**  
1,5 x 29,75 cm - 0.59" x 11.71"  
G-5085 / 5085

## SPECIAL PIECES.PEZZI SPECIALI.PIEZAS ESPECIALES

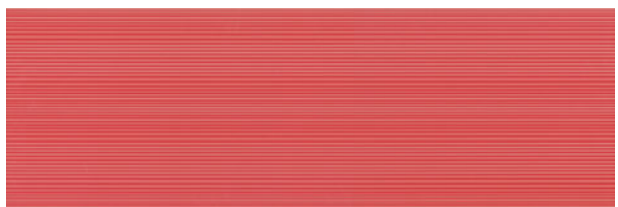

**Gallery wall red rigato mate**  
22,21 x 89,46 cm - 8.75" x 35.22"  
G-6312



**Byte red lista 90**  
2 x 89,46 cm - 0.79" x 35.22"  
G-5173



**Fusion graffiato lista 90**  
1,5 x 89,46 cm - 0.59" x 35.22"  
G-5091



**Pod red lista 60**  
1,5 x 59,55 cm - 0.59" x 23.45"  
G-5100

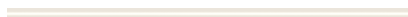

**Fusion natural lista 60**  
1 x 59,55 cm - 0.39" x 23.45"  
G-5049



**Fusion graffiato lista 60**  
1,5 x 59,55 cm - 0.59" x 23.45"  
G-5069



**Byte ice / yellow / red / black lista 60**  
1,5 x 59,55 cm - 0.59" x 23.45"  
G-5100



**Steel corner**  
1 x 250 cm - 0.39" x 98.42"  
G-5503



**Steel corner**  
1 x 250 cm - 0.39" x 98.42"  
G-5503

## FLOOR TILES. PAVIMENTO.PAVIMENTO

FORMATS.FORMATI.FORMATOS

30 x 60 cm

COLOURS.COLORI.COLORES



FINISHES.FINITURE.ACABADOS

pulido  
satinado  
rigue

See floor tiles collection on page 170.  
Ver colección completa de pavimento  
en página 170.

\* Recommended only for wall. /  
solo recomendado como revestimiento.



GALLERY WALL

# GALLERY WALL orange\*

PLAIN TILES.BASE.BASES

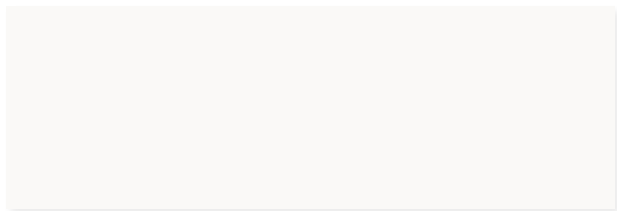

**Gallery wall white brillo / mate**  
29,75 x 89,46 cm - 11.71" x 35.22"  
G-6240 / 6240



**Gallery wall orange mate**  
29,75 x 89,46 cm - 11.71" x 35.22"  
G-6258



**Gallery wall orange mate**  
14,70 x 89,46 cm - 5.79" x 35.22"  
G-6300



**Gallery wall orange rigato mate**  
29,75 x 89,46 cm - 11.71" x 35.22"  
G-6300



**Byte orange lista 90**  
2 x 89,46 cm - 0.79" x 35.22"  
G-5173



**Fusion graffiato lista 90**  
1,5 x 89,46 cm - 0.59" x 35.22"  
G-5091

\* Recommended only for wall. /  
sólo recomendado como revestimiento.

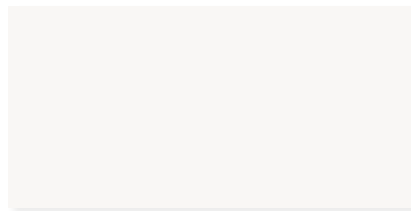

**Gallery wall white brillo**  
29,75 x 59,55 cm - 11.71" x 23.45"  
G-6208 / 6208



**Gallery wall orange brillo**  
29,75 x 59,55 cm - 11.71" x 23.45"  
G-6240



**Gallery orange brillo corner 60**  
1,5 x 59,55 cm - 0.59" x 23.45"  
G-5155



**Gallery white brillo / mate corner 30**  
1,5 x 29,75 cm - 0.59" x 11.71"  
G-5085 / 5085



**Gallery orange brillo / mate corner 30**  
1,5 x 29,75 cm - 0.59" x 11.71"  
G-5085 / 5085

## SPECIAL PIECES.PEZZI SPECIALI.PIEZAS ESPECIALES



**Pod orange lista 60**  
1,5 x 59,55 cm - 0.59" x 23.45"  
G-5100



**Fusion natural lista 60**  
1 x 59,55 cm - 0.39" x 23.45"  
G-5049



**Fusion graffiato lista 60**  
1,5 x 59,55 cm - 0.59" x 23.45"  
G-5069



**Byte ice / yellow / red / black lista 60**  
1,5 x 59,55 cm - 0.59" x 23.45"  
G-5100



**Steel corner**  
1 x 250 cm - 0.39" x 98.42"  
G-5503



## FLOOR TILES. PAVIMENTO.PAVIMENTO

FORMATS.FORMATI.FORMATOS

30 x 60 cm

COLOURS.COLORI.COLORES



FINISHES.FINITURE.ACABADOS

pulido  
satinado  
rigue

See floor tiles collection on page 170.  
Ver colección completa de pavimento  
en página 170.

# GALLERY WALL **black**\*

PLAIN TILES.BASE.BASES

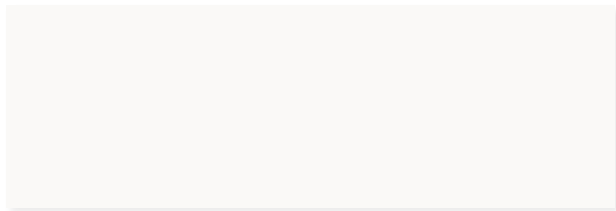

**Gallery wall white brillo / mate**  
29,75 x 89,46 cm - 11.71" x 35.22"  
G-6240 / 6240



**Gallery wall black mate**  
29,75 x 89,46 cm - 11.71" x 35.22"  
G-6258



**Gallery wall black mate**  
14,70 x 89,46 cm - 5.79" x 35.22"  
G-6300

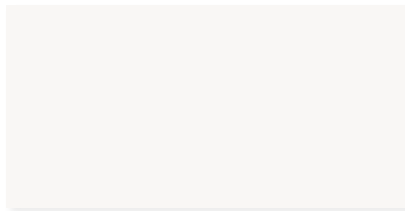

**Gallery wall white brillo**  
29,75 x 59,55 cm - 11.71" x 23.45"  
G-6208 / 6208



**Gallery wall black brillo**  
29,75 x 59,55 cm - 11.71" x 23.45"  
G-6240



**Gallery black brillo corner 60**  
1,5 x 59,55 cm - 0.59" x 23.45"  
G-5155



**Gallery white brillo / mate corner 30**  
1,5 x 29,75 cm - 0.59" x 11.71"  
G-5085 / 5085



**Gallery black brillo / mate corner 30**  
1,5 x 29,75 cm - 0.59" x 11.71"  
G-5085 / 5085

## SPECIAL PIECES.PEZZI SPECIALI.PIEZAS ESPECIALES

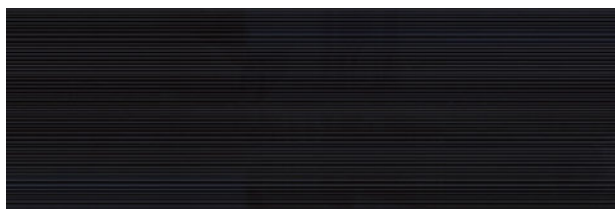

**Gallery wall black rigato mate**  
29,75 x 89,46 cm - 11.71" x 35.22"  
G-6300



**Byte black lista 90**  
2 x 89,46 cm - 0.79" x 35.22"  
G-5173



**Fusion graffiato lista 90**  
1,5 x 89,46 cm - 0.59" x 35.22"  
G-5091

\* Recommended only for wall. /  
sólo recomendado como revestimiento.



**Pod black lista 60**  
1,5 x 59,55 cm - 0.59" x 23.45"  
G-5100



**Fusion natural lista 60**  
1 x 59,55 cm - 0.39" x 23.45"  
G-5049



**Fusion graffiato lista 60**  
1,5 x 59,55 cm - 0.59" x 23.45"  
G-5069



**Byte ice / yellow / red / black lista 60**  
1,5 x 59,55 cm - 0.59" x 23.45"  
G-5100



**Steel corner**  
1 x 250 cm - 0.39" x 98.42"  
G-5503

## FLOOR TILES. PAVIMENTO.PAVIMENTO

FORMATS.FORMATI.FORMATOS

30 x 60 cm

COLOURS.COLORI.COLORES



FINISHES.FINITURE.ACABADOS

pulido  
satinado  
rigue

See floor tiles collection on page 170.  
Ver colección completa de pavimento  
en página 170.

GALLERY WALL

# GALLERY WALL **blue**\*

PLAIN TILES.BASE.BASES

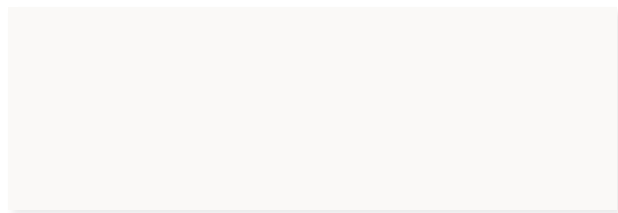

**Gallery wall white brillo / mate**  
29,75 x 89,46 cm - 11.71" x 35.22"  
G-6240 / 6240



**Gallery wall blue mate**  
29,75 x 89,46 cm - 11.71" x 35.22"  
G-6270



**Gallery wall blue mate**  
14,70 x 89,46 cm - 5.79" x 35.22"  
G-6312

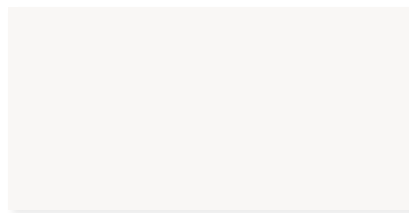

**Gallery wall white brillo**  
29,75 x 59,55 cm - 11.71" x 23.45"  
G-6208 / 6208



**Gallery wall blue brillo**  
29,75 x 59,55 cm - 11.71" x 23.45"  
G-6254



**Gallery blue brillo corner 60**  
1,5 x 59,55 cm - 0.59" x 23.45"  
G-5155



**Gallery white brillo / mate corner 30**  
1,5 x 29,75 cm - 0.59" x 11.71"  
G-5085 / 5085



**Gallery blue brillo / mate corner 30**  
1,5 x 29,75 cm - 0.59" x 11.71"  
G-5085 / 5085

## SPECIAL PIECES.PEZZI SPECIALI.PIEZAS ESPECIALES



**Gallery wall blue rigato mate**  
29,75 x 89,46 cm - 11.71" x 35.22"  
G-6312



**Byte blue lista 90**  
2 x 89,46 cm - 0.79" x 35.22"  
G-5173



**Fusion graffiato lista 90**  
1,5 x 89,46 cm - 0.59" x 35.22"  
G-5091



**Pod blue lista 60**  
1,5 x 59,55 cm - 0.59" x 23.45"  
G-5100



**Fusion natural lista 60**  
1 x 59,55 cm - 0.39" x 23.45"  
G-5049



**Fusion graffiato lista 60**  
1,5 x 59,55 cm - 0.59" x 23.45"  
G-5069



**Byte ice / yellow / red / black lista 60**  
1,5 x 59,55 cm - 0.59" x 23.45"  
G-5100



**Steel corner**  
1 x 250 cm - 0.39" x 98.42"  
G-5503

## FLOOR TILES. PAVIMENTO.PAVIMENTO

FORMATS.FORMATI.FORMATOS

30 x 60 cm

COLOURS.COLORI.COLORES



FINISHES.FINITURE.ACABADOS

putido  
satinado  
rigue

See floor tiles collection on page 170.  
Ver colección completa de pavimento en página 170.

\* Recommended only for wall. /  
sólo recomendado como revestimiento.



GALLERY WALL

PRIMARY SCHOOL  
Castellón. (SPAIN)  
Arch. NACHO CARBÓ / RAFAEL CULLA

# ISMO

WOOD

## PLAIN TILES. BASE. BASES



### Ismo moka natural / lappato

59,55 x 59,55 cm - 23.45" x 23.45"

G-6386 marfil natural / G-6426 marfil lappato  
G-6372 beige natural / G-6410 beige lappato  
G-6372 moka natural / G-6410 moka lappato  
G-6372 antracita natural



### Ismo moka natural / lappato

29,75 x 59,55 cm - 11.71" x 23.45"

G-6314 marfil lappato  
G-6298 beige lappato  
G-6258 moka natural / G-6298 moka lappato  
G-6258 antracita natural

COLOURS  
COLORI  
COLORES

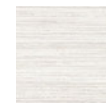

Marfil



Beige

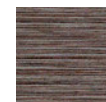

Moka

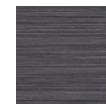

Antracita

## SPECIAL PIECES. PEZZI SPECIALI. PIEZAS ESPECIALES



### Ismo mosaico lappato 2,5x2,5

29,75x29,75 cm - 11.71"x11.71"

G-6756 marfil lappato  
G-6756 beige lappato  
G-6756 moka lappato  
G-6756 antracita lappato



### Ismo multicolor lappato mosaico 2,5x2,5

29,75x29,75 cm - 11.71"x11.71"

G-6756 marfil lappato  
G-6756 beige lappato  
G-6756 moka lappato  
G-6756 antr. lappato



### Ismo lappato módulo 30X60

29,75x59,55 cm - 11.71"x23.45"

G-5311 marfil lappato  
G-5311 beige lappato  
G-5311 moka lappato

Natural / Lappato

**CLASE 1**

UNE - ENV 12633



### Ismo mosaico lappato 2,5x30

29,75x29,75 cm - 11.71"x11.71"

G-6756 marfil lappato  
G-6756 beige lappato  
G-6756 moka lappato  
G-6756 antracita lappato



### 30X30 multicolor lappato mosaico 1,5x30

29,75x29,75 cm - 11.71"x11.71"

G-6756 marfil lappato  
G-6756 beige lappato  
G-6756 moka lappato  
G-6756 antr. lappato



### Ismo natural rodapié-60

7,2x59,55 cm - 2.83"x23.45"

G-5097 marfil natural  
G-5097 beige natural  
G-5097 moka natural  
G-5097 antracita natural

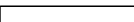

### Ismo natural / lappato lista

7,2x59,55 cm - 2.83"x23.45"

G-5087 marfil natural / G-5091 marfil lappato  
G-5087 beige natural / G-5091 beige lappato  
G-5087 moka natural / G-5091 moka lappato  
G-5087 antracita natural



Ismo Moka Natural 59,55x59,55 cm

ISMO

OLIVIER RESTAURANT  
Lisboa. (PORTUGAL)  
Arch. Sofia COSTA



# ORIGIN

STONE

## PLAIN TILES.BASE.BASES

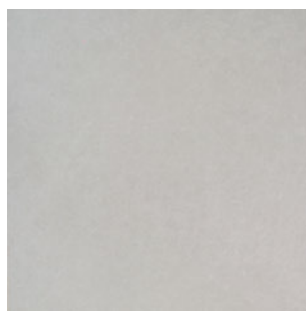

### Origin gris lappato

44,63 x 44,63 cm - 17.57" x 17.57"

G-6300 marfil lappato

G-6258 crema natural / G-6286 crema lappato

G-6258 gris lappato

G-6258 savanna lappato

G-6234 antracita natural

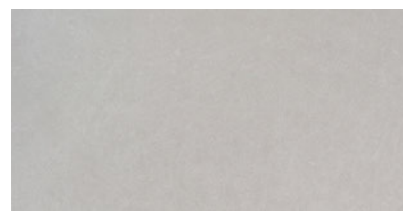

### Origin gris natural

29,75 x 59,55 cm - 11.71" x 23.45"

G-6234 gris natural

G-6234 savanna natural / G-6258 savanna lappato

COLOURS  
COLORI  
COLORES



Marfil



Crema



Gris

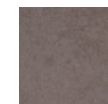

Savanna

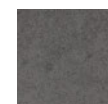

Antracita

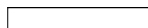

### Origin natural cenefa-1

9,60x59,55 cm - 3.78"x23.45"

G-5087 savanna natural



### Origin listelo 60

7,2x59,55 cm - 2.83"x23.45"

G-5085 gris natural

G-5085 savanna natural

G-5087 savanna lappato



### Origin listelo 45

7,2x59,55 cm - 2.83"x23.45"

G-5083 marfil natural

G-5081 crema natural

G-5071 crema lappato

G-5067 savanna lappato



### Origin listelo 30

7,2x59,55 cm - 2.83"x23.45"

G-5054 gris natural

G-5053 savanna natural

G-5055 savanna lappato

## SPECIAL PIECES. PEZZI SPECIALI.PIEZAS ESPECIALES



### Origin mosaico lappato 2,5x2,5

29,75x29,75 cm - 11.71"x11.71"

G-6780 marfil lappato

G-6756 crema lappato

G-6756 gris lappato

G-6756 savanna lappato



### Origin mosaico lappato 2,5x10

29,75x29,75 cm - 11.71"x11.71"

G-6708 marfil lappato

G-6688 crema lappato

G-6688 gris lappato

G-6688 savanna lappato



### Origin lappato corte

29,75x29,75 cm - 11.71"x11.71"

G-5161 crema lappato

G-5161 savanna lappato



### Origin lappato listelo sin fin

29,75x29,75 cm - 11.71"x11.71"

G-5155 marfil lappato

G-5155 crema lappato

G-5155 savanna lappato



### Origin preincisión 2,5x60

29,75x59,55 cm - 11.71"x23.45"

G-6486 savanna lappato



### Origin natural rodapié-60

7,2x59,55 cm - 2.83"x23.45"

G-5095 gris natural

G-5095 savanna natural



### Origin natural rodapié-45

7,2x59,55 cm - 2.83"x23.45"

G-5083 marfil natural

G-5081 crema natural



### Origin natural rodapié-30

7,2x59,55 cm - 2.83"x23.45"

G-5056 gris natural

G-5065 savanna natural

Natural / Lappato

CLASE 1

UNE - ENV 12633



Origin Gris Lappato 29,75x59,55 cm

BLANCO & NEGRO OPTICIAN'S  
Elda, Alicante. [SPAIN]

ORIGIN

# DAGON

STONE

## PLAIN TILES.BASE.BASES

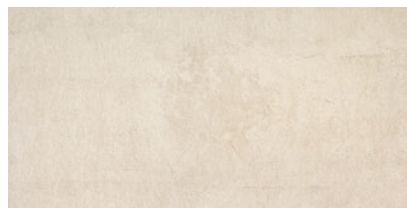

**Micerino marfil natural / lappato**  
29,75 x 59,55 cm - 11.71" x 23.45"  
G-6258 / 6298



**Micerino beige natural**  
29,75 x 59,55 cm - 11.71" x 23.45"  
G-6258

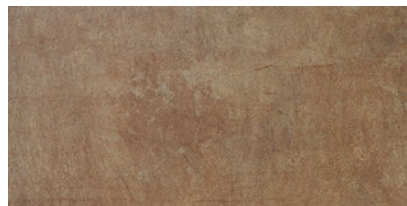

**Micerino siena natural**  
29,75 x 59,55 cm - 11.71" x 23.45"  
G-6234

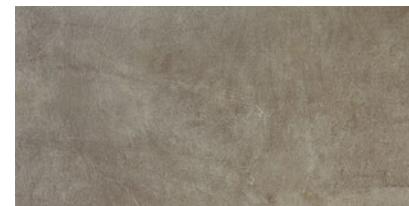

**Micerino vison natural**  
29,75 x 59,55 cm - 11.71" x 23.45"  
G-6234 / 6274



**Micerino savanna natural / lappato**  
29,75 x 59,55 cm - 11.71" x 23.45"  
G-6258 / 6298

## SPECIAL PIECES. PEZZI SPECIALI.PIEZAS ESPECIALES



**Abidos lappato  
mosaico 2,5x10**  
29,75 x 29,75 cm - 11.71" x 11.71"  
G-6688



**Abidos lappato  
mosaico 2,5x2,5**  
29,75 x 29,75 cm - 11.71" x 11.71"  
G-6756



**Abidos lappato  
mosaico sin fin**  
29,75 x 29,75 cm - 11.71" x 11.71"  
G-5155



**Abidos natural rodapié 30**  
7,3 x 29,75 cm - 2.87" x 11.71"  
G-5065 siena / vison  
G-5067 marfil / beige / savanna

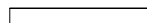

**Micerino listelo**  
7,3 x 59,55 cm - 2.87" x 23.45"  
G-5087 savanna nat G-5091 savanna lap  
G-5085 vison nat G-5087 marfil nat  
G-5091 marfil lap  
G-5085 siena nat  
G-5087 beige nat



**Micerino lappato cenefa-1**  
9,74 x 59,55 cm - 3.84" x 23.45"  
G-5089 savanna  
G-5097 marfil



**Abidos listelo 30**  
7,3 x 59,55 cm - 2.87" x 23.45"  
G-5055 savanna nat G-5057 savanna lap  
G-5053 vison nat G-5053 siena nat  
G-5055 siena lap G-5057 marfil lap  
G-5055 marfil nat  
G-5055 beige nat



**Micerino natural rodapié 60**  
7,3 x 59,55 cm - 2.87" x 23.45"  
G-5095 siena / vison  
G-5097 marfil / beige / savanna

Natural

CLASE 1

UNE - ENV 12633

# JERUSALEM

STONE

## PLAIN TILES.BASE.BASES



**Jerusalem grey natural**  
59,55 x 59,55 cm - 23.45" x 23.45"  
G-6286

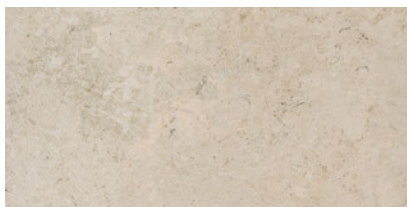

**Jerusalem grey natural**  
29,75 x 59,55 cm - 11.71" x 23.45"  
G-6218

## SPECIAL PIECES. PEZZI SPECIALI.PIEZAS ESPECIALES



**30X30 mosaico 3D 5x5**  
29,75x29,75 cm - 11.71"x11.71"



**30X30 mosaico 5x5**  
29,75x29,75 cm - 11.71"x11.71"



**7,5X60 rodapié**  
7,3x59,55 cm - 2.87"x23.45"



**Jerusalem visón natural**  
59,55 x 59,55 cm - 23.45" x 23.45"  
G-6286

## COMPLEMENTS.COMPLEMENTI. COMPLEMENTOS



**Byte white / moss / red / black lista 60\***  
1,5 x 59,55 cm - 0.59" x 23.45"

G-5100

**Fusion natural lista 60\***  
1 x 59,55 cm - 0.39" x 23.45"

G-5049

**Fusion graffiato lista 60**  
1,5 x 59,55 cm - 0.59" x 23.45"

G-5069

\* recommended only for walls

## STEPS. GRADINI.PELDAÑOS

		natural	
SIMPLE		peldaño simple-30 (30x60 cm)	5171
		peldaño simple-60 (30x60 cm)	5171
		peldaño simple áng. (30x60 cm)	5187
		peldaño simple (60x60 cm)	5281
		peldaño simple áng. (60x60 cm)	5299
GRADONE		natural	
		peldaño grad-30 (30x60 cm)	5559
		peldaño grad-60 (30x60 cm)	5559
		peldaño grad áng. (30x60 cm)	5609
		peldaño gradone (60x60 cm)	5559
peldaño grad. áng (60x60 cm)	5609		

+ INFO pag. 221

# JAMTLAND

STONE

## PLAIN TILES.BASE.BASES

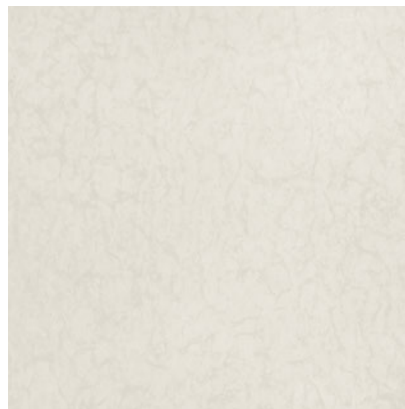

**Jamtland ivory natural / lappato**  
59,55 x 59,55 cm - 23.45" x 23.45"  
G-6330 / G-6372

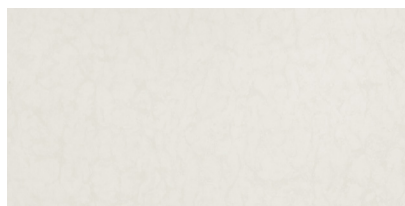

**Jamtland ivory natural / lappato**  
29,75 x 59,55 cm - 11.71" x 23.45"  
G-6258 / G-6298



**Jamtland ivory natural / lappato listelo**  
7,3 x 59,55 cm - 2.87" x 23.45"  
G-5087 / G-5091



**Jamtland graphite natural / lappato**  
59,55 x 59,55 cm - 23.45" x 23.45"  
G-6330 / G-6372

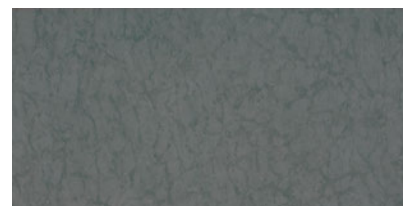

**Jamtland graphite natural / lappato**  
29,75 x 59,55 cm - 11.71" x 23.45"  
G-6258 / G-6298



**Jamtland graphite natural / lappato listelo**  
7,3 x 59,55 cm - 2.87" x 23.45"  
G-5087 / G-5091

## SPECIAL PIECES. PEZZI SPECIALI.PIEZAS ESPECIALES

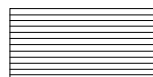

**30X60 preincisión 2,5x60**  
29,75x59,55 cm - 11.71"x23.45"



**30X30 mosaico 5x5**  
29,75x29,75 cm - 11.71"x11.71"

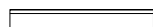

**7,5X60 rodapié**  
7,3x59,55 cm - 2.87"x23.45"

## STEPS. GRADINI.PELDAÑOS

SIMPLE			natural	lappato
	peldaño simple-30	(30x60 cm)	5171	5195
peldaño simple-60	(30x60 cm)	5171	5195	
peldaño simple áng.	(30x60 cm)	5187	5211	
peldaño simple	(60x60 cm)	5281	5281	
peldaño simple áng.	(60x60 cm)	5299	5299	

GRADONE			natural	lappato
	peldaño grad-30	(30x60 cm)	5559	5559
peldaño grad-60	(30x60 cm)	5559	5559	
peldaño gradone áng.	(30x60 cm)	5609	5609	
peldaño gradone	(60x60 cm)	5559	5559	
peldaño grad. áng	(60x60 cm)	5609	5609	

+ INFO pag 221

# COMPLEMENTS. COMPLEMENTI. OTRAS COMPLEMENTOS

## GLASS. VETRO. CRISTAL



Byte white / ice / yellow / orange / red / purple / blue / grey / moss / black lista 90 \*  
2 x 89,46 cm - 0.79" x 35.22"



G-5173



Byte ice / yellow / red / black lista 60 \*  
1,5 x 59,55 cm - 0.59" x 23.45"



G-5100



Pod white / ice / yellow / orange / red / purple / blue / black lista 60 \*  
1,5 x 59,55 cm - 0.59" x 23.45"



G-5100

## METAL. METALLO. METAL



Fusion graffiato lista 90 \*\*  
1,5 x 89,46 cm - 0.59" x 35.22"



G-5091



Fusion graffiato lista 60 \*\*  
1,5 x 59,55 cm - 0.59" x 23.45"



G-5069



Fusion lista 60 \*  
1 x 59,55 cm - 0.39" x 23.45"



G-5049

## CORNERS. ANGOLI. ESQUINAS

### GALLERY WALL



Gallery white brillo / mate corner 60 \*  
1,5 x 59,55 cm - 0.59" x 23.45"



G-5155



Gallery lime / orange / red / blue / black brillo corner 60 \*  
1,5 x 59,55 cm - 0.59" x 23.45"



G-5155



Gallery white / lime / orange / red / blue / black brillo / mate corner 30 \*  
1,5 x 29,75 cm - 0.59" x 11.71"



G-5085



Steel corner  
1 x 250 cm - 0.39" x 98.42"

G-5503

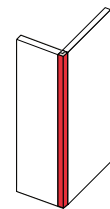
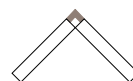

Ceramic corner.  
Angoli ceramico.  
Esquina cerámica

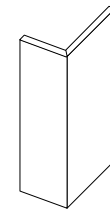

Miter.  
Jolly.  
Inglete

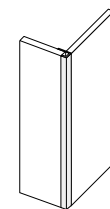
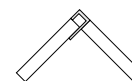

Metallic profile.  
Perfil metallico.  
Perfil metálico

\* recommended only for walls

\*\* recommended for walls and floors

# CORNER SOLUTIONS. SOLUZIONE DI ANGOLI. SOLUCIONES DE ESQUINAS.

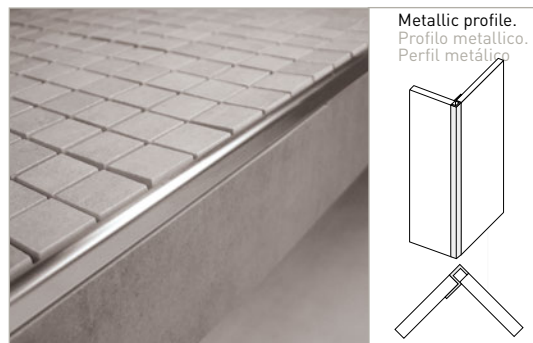
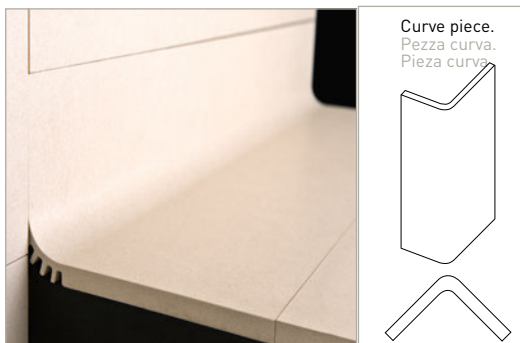
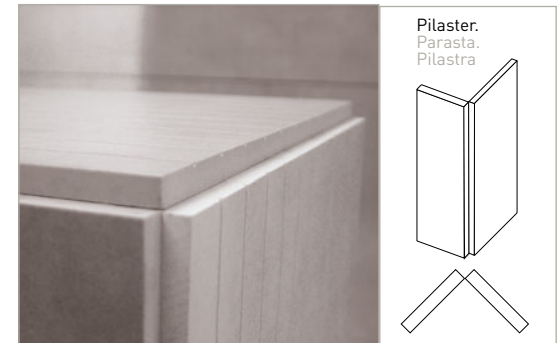
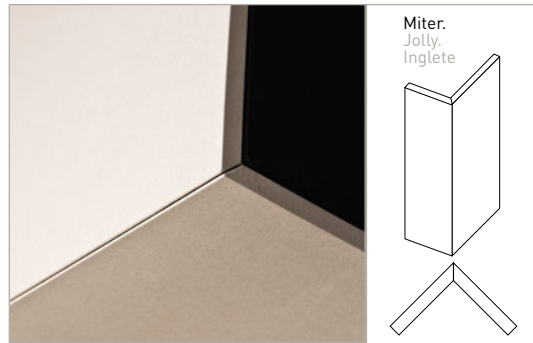
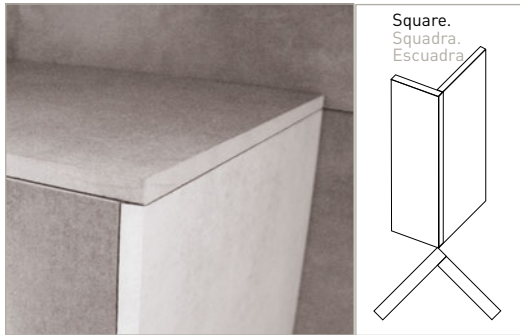

TECHNICAL SOLUTIONS. SOLUZIONI TECNICHE. SOLUCIONES TÉCNICAS.

# SPECIAL PIECES. PEZZI SPECIALI. PIEZAS ESPECIALES.

## Skirtings. Rodapiés

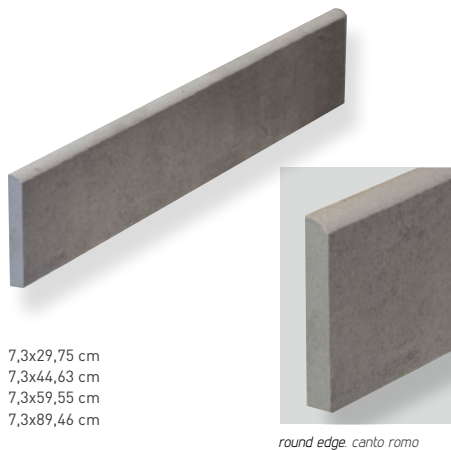

## Borders. Listelos



## Zanquín

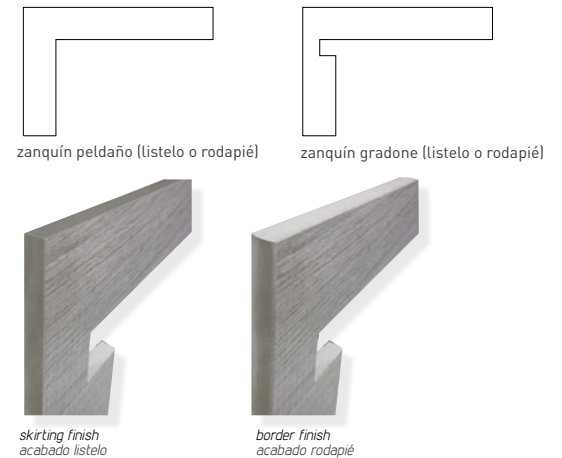

# STEPS. GRADINI. PELDAÑOS.

## Simple



30x120 cm - 45x90 cm - 30x60 cm

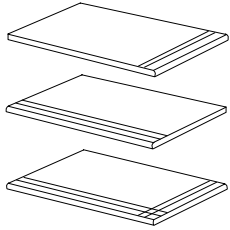

90x90 cm - 60x60 cm - 45x45 cm

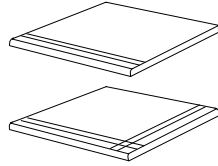

59,55x51,57 Hexagonal

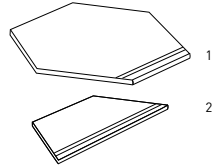

[ Commercial formats  
Formatos comerciales ]

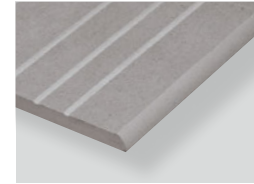

## Gradone



30x120 cm - 45x90 cm - 30x60 cm

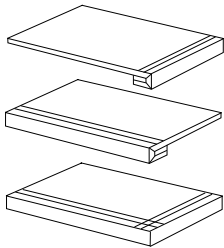

90x90 cm - 60x60 cm - 45x45 cm

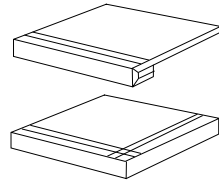

59,55x51,57 Hexagonal

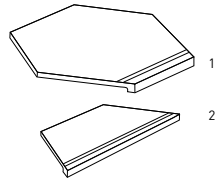

[ Commercial formats  
Formatos comerciales ]

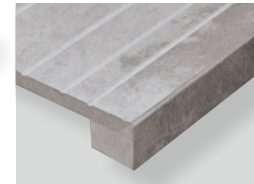

## Steps

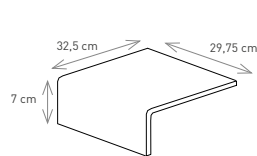

Step 30x60 cm\*

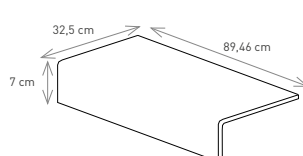

Step 45x90 cm\*

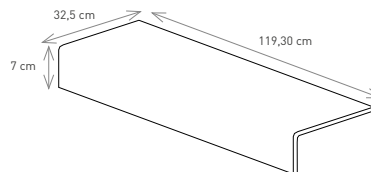

Step 60x120 cm\*

Commercial formats  
Formatos comerciales



\* Upon request. In quantities at least 100 units. Deadline: 60 days. / Artículo sobre pedido. Cantidad mínima: 100 piezas. Plazo de entrega: 60 días.

\* For further detail information, please check with our commercial network. / Para la obtención de una información detallada consultar a la red comercial.

All these products are also available without grooves. For availability of steps of each collection and its price groups go to each collection pages.

To purchase steps you should specify the relevant reference needed:

\*model name + colour + finish + size + step specific reference + with or without grooves.

Examples: Civic Grey Natural 45x90 Gradone 45 with grooves or Portland Grey Natural 60x60 Peldaño Ángulo without grooves.

Todos estos productos también se pueden realizar sin ranuras bajo indicación expresa. Para conocer la disponibilidad de peldaños de cada colección y sus grupos de precio dirigirse a las páginas específicas de la colección deseada.

Para realizar el pedido de peldaños se debe referenciar de la siguiente manera:

\*nombre del modelo + color + acabado + formato + referencia específica del peldaño + sin o con ranuras.

Ejemplos: Civic Grey Natural 45x90 Gradone 45 con ranuras o Portland Grey Natural 60x60 Peldaño Ángulo sin ranuras.

# 3D CONCEPT

Our 3D Concept collection is the result of a development process that started with the sole purpose of creating a differentiated product that could become the most important decorative element in any project. Our piece UP was the beginning of this exclusive collection and it is now available in a total of six different shapes.

La nostra collezione 3D Concept è il risultato di un processo di sviluppo che è iniziato con l'intenzione di creare un prodotto differenziato che potrebbe diventare l'elemento decorativo più importante in qualsiasi progetto. Il nostro pezzo UP è stato l'inizio di questa esclusiva collezione che ha un totale di sei modelli differenti.

La Colección 3D Concept es el resultado de un proceso de desarrollo que se inició con la única finalidad de crear un producto diferenciado que pudiera convertirse en el elemento decorativo de mayor importancia en cualquier proyecto. Nuestra pieza UP fue el comienzo de esta exclusiva colección que hoy dispone de un total de seis formas diferentes.



3-DIMENSIONAL PIECES. PEZZI TRIDIMENSIONALE. PIEZAS TRIDIMENSIONALES.

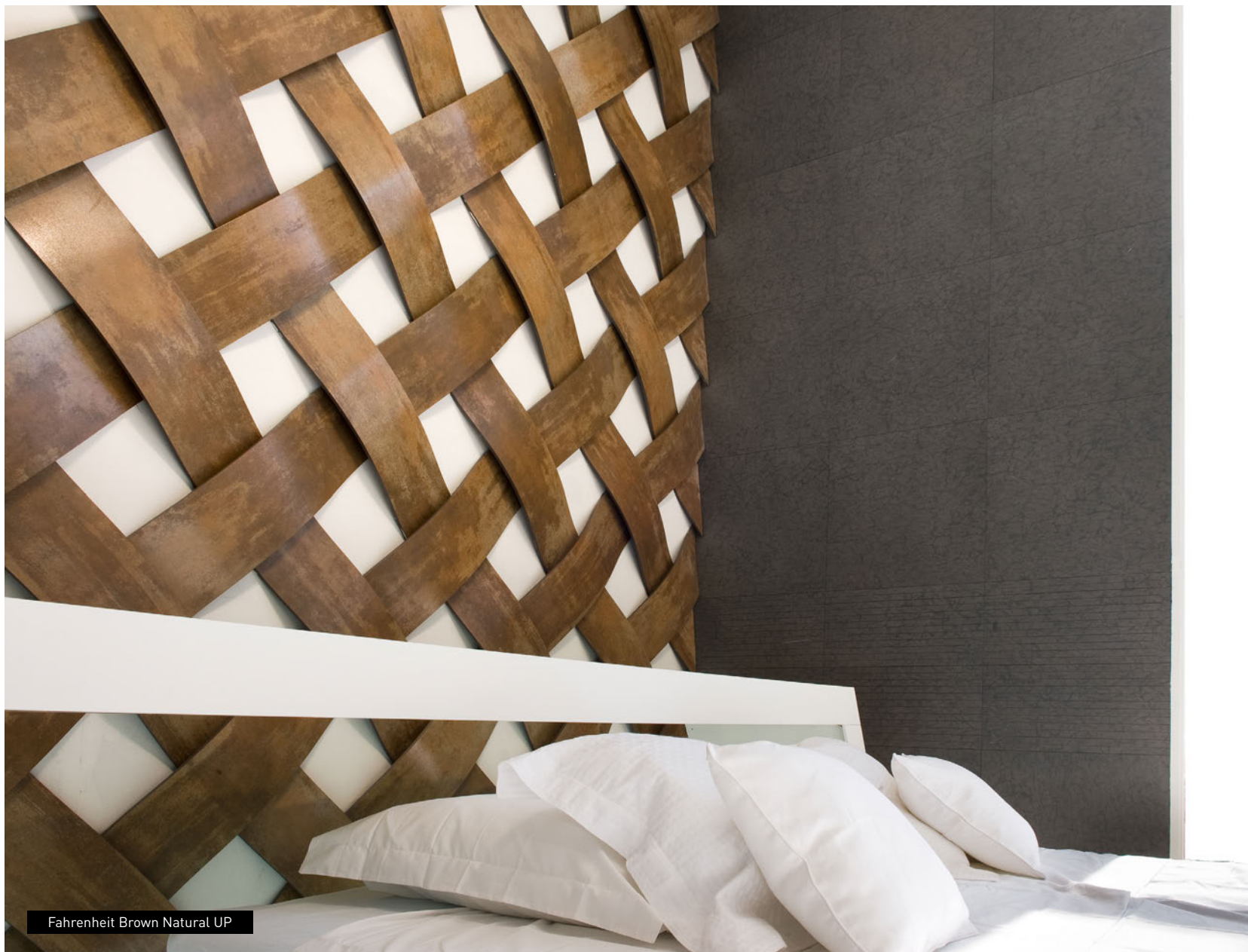

Fahrenheit Brown Natural UP

# 3D CONCEPT

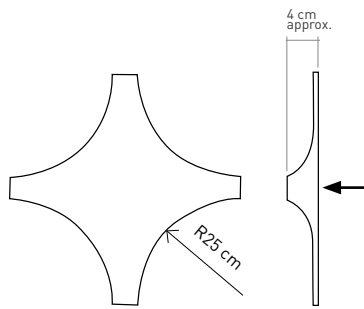

## STAR

59,55 x 58,88 cm - 23.45" x 23.18"

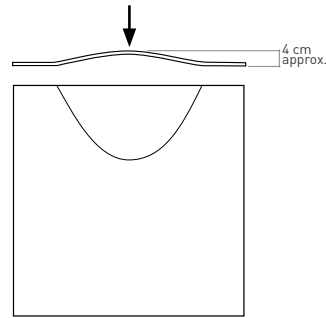

## BAG

89,46 x 89,46 cm - 35.22" x 35.22"  
59,55 x 59,55 cm - 23.45" x 23.45"  
44,63 x 89,46 cm - 17.57" x 35.22"

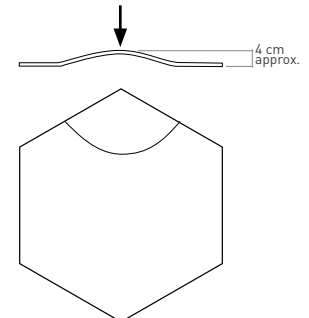

## HEXAGONAL BAG

51,57 x 59,55 cm - 20.30" x 23.45"



# 3-DIMENSIONAL PIECES. PEZZI TRIDIMENSIONALE. PIEZAS TRIDIMENSIONALES.

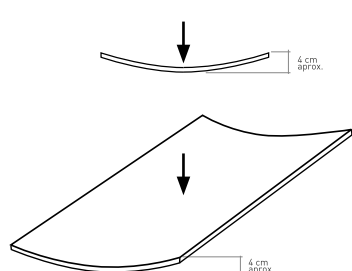

**CAVE**  
44,10 x 89,46 cm - 17.36" x 35.22"

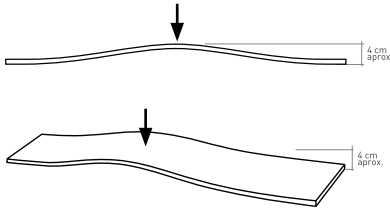

**UP**  
19,71 x 118,80 cm - 7.76" x 46.77"  
14,74 x 118,80 cm - 5.80" x 46.77"  
29,75 x 88,80 cm - 11.71" x 34.96"  
22,21 x 88,80 cm - 8.74" x 34.96"  
14,74 x 88,80 cm - 5.80" x 34.96"

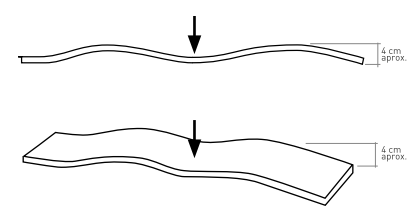

**UP-2**  
19,71 x 118,80 cm - 7.76" x 46.77"  
14,74 x 118,80 cm - 5.80" x 46.77"  
29,75 x 88,80 cm - 11.71" x 34.96"  
22,21 x 88,80 cm - 8.74" x 34.96"  
14,74 x 88,80 cm - 5.80" x 34.96"

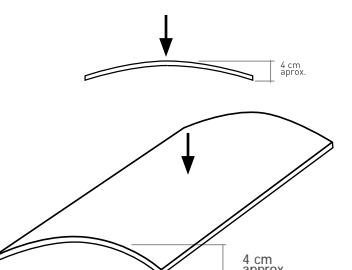

**VEXA**  
44,10 x 89,46 cm - 17.36" x 35.22"

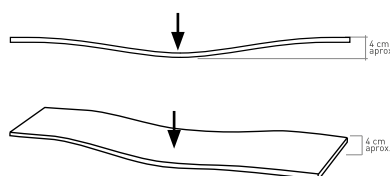

**DOWN**  
19,71 x 118,80 cm - 7.76" x 46.77"  
14,74 x 118,80 cm - 5.80" x 46.77"  
29,75 x 88,80 cm - 11.71" x 34.96"  
22,21 x 88,80 cm - 8.74" x 34.96"  
14,74 x 88,80 cm - 5.80" x 34.96"

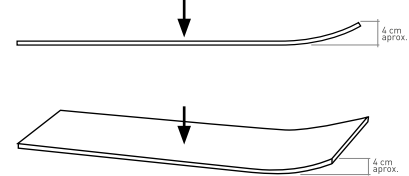

**END - UP**  
19,71 x 118,80 cm - 7.76" x 46.77"  
14,74 x 118,80 cm - 5.80" x 46.77"  
29,75 x 88,80 cm - 11.71" x 34.96"  
22,21 x 88,80 cm - 8.74" x 34.96"  
14,74 x 88,80 cm - 5.80" x 34.96"

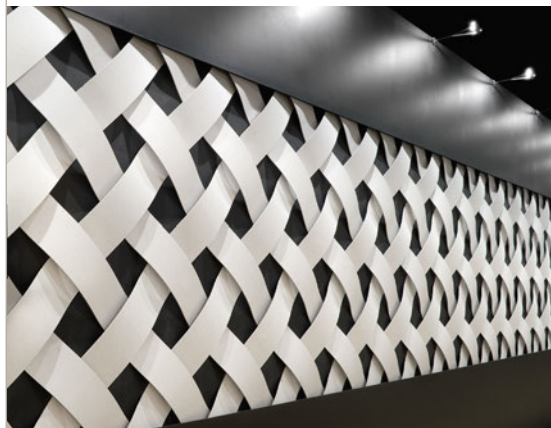

TECHNICAL SOLUTIONS

\*Check prices and the availability to manufacture the different "3Dimensional" pieces with the items of the LAND PORCELANICO's collections with our commercial network.  
Consulten precios y la posibilidad de realizar las diferentes piezas "3Dimensional" con los materiales de las diferentes colecciones de LAND PORCELANICO con nuestra red comercial.

## VENTILATED FAÇADES. FACCIATE VENTILATE. FACHADAS VENTILADAS.

The Ventilated Façade system is an exterior cladding system for buildings offering a combination between the maximum level of aesthetic appeal and technical advantages for any new building or renovation.

From the structural point of view, this is a system composed of an external facade made of porcelain stoneware slabs that are mechanically anchored to the perimeter framework of the building by means of a structure in aluminium alloy. Due to the particular characteristics of this construction technique, the surface of the cladding remains separate from the masonry. The resulting cavity is partially occupied by a layer of thermal insulating material, leaving the rest of the space empty to allow ventilation. Therefore a continuous flow of aeration is created providing significant benefits such as:

- Energy saving, thermal insulation and sound proofing. Protection against water.
- Healthier environment - in terms of breathability and a decrease of heat loads.
- No deterioration of the appearance or technical structure over time.
- Exceptional results in renovation works.
- Security when fixing coatings due to the mechanical and chemical anchorage.
- Easy to clean, maintain and manipulate.

### TYPES OF SYSTEMS

**Visible system:** The anchorage of the material by mounting clips, causes it to be visible from the outside. This system does not require any manipulation of the pieces.

**Hidden system:** The anchorage takes place by using the side grooves that have to be made on the profiles of every piece of porcelain in order for the clips not to be seen from the outside.

La facciata ventilata in ceramica è un sistema di rivestimento esterno degli edifici ideale nell'abbinare il massimo livello di appeal estetico con le migliori prestazioni termiche. Dal punto di vista strutturale si presenta come un sistema a sbalzo, costituito da un paramento esterno in lastre di gres porcellanato fissato meccanicamente all'intelaiatura perimetrale dell'edificio attraverso una struttura in lega di alluminio. Grazie a quest'aparticolare tecnica costruttiva, la superficie del rivestimento resta separata dalla muratura. L'intercapedine che ne risulta viene parzialmente occupata da uno strato di materiale termoisolante, lasciando vuoto il resto dello spazio per consentire la ventilazione. Viene così a crearsi una "lama d'aria", cioè un flusso continuo di aerazione, che apporta significativi benefici in termini di traspirabilità e di diminuzione dei carichi termici.

### VANTAGGI:

- Risparmio energetico e isolamento termico.
- Protezione dall'acqua.
- Maggiore salubrità dell'ambiente.
- Nessun deterioramento estetico e tecnico.
- Eccezionale nelle ristrutturazioni.
- Isolamento acustico.

La fachada cerámica ventilada es un sistema de revestimiento exterior de edificios, la combinación ideal entre el máximo nivel estético y las mejores características térmicas. Desde el punto de vista estructural, es un sistema voladizo, compuesto de una cara externa de piezas de gres porcelánico fijadas mecánicamente al perímetro del edificio por medio de una estructura de perfiles de aluminio. Gracias a esta técnica la superficie del revestimiento se mantiene separada de la mampostería. La cavidad resultante está parcialmente ocupada por una capa de material aislante térmico, dejando el resto del espacio vacío para permitir la ventilación. De esta manera se crea un flujo continuo de aireación, que proporciona beneficios significativos en términos de transpirabilidad y una disminución de las cargas térmicas.

### VENTAJAS:

- Ahorro de energía y aislamiento térmico.
- Protección contra el agua.
- Medio ambiente más saludable.
- Sin deterioro del aspecto de la fachada exterior ni de las características técnicas por el paso del tiempo.
- Resultados excepcionales en obras de renovación.
- Mayor aislamiento acústico.

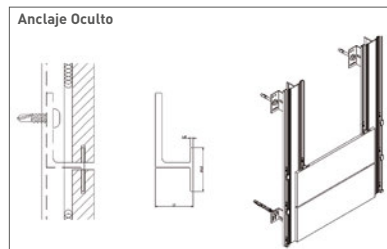
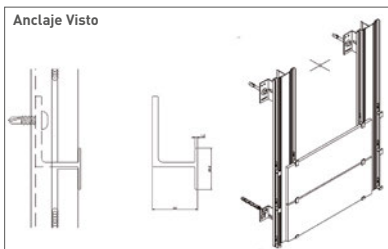

PRIVATE HOUSE  
Ourense, Galicia (SPAIN)  
AUSTRAL Collection

## GLUED FAÇADES WITH MECHANICAL ANCHORAGE. PARETI CON ANCORAGGIO MECCANICO. FACHADAS PEGADAS CON ANCLAJE MECÁNICO.

The Bonded Façade system upgrades the appearance of façades as they provide a modern and innovative appearance that will be durable in time due to the use of our high-end technical porcelain. Currently, there are adhesives that enable an optimum bonding on the façade, however, in order to ensure maximum security, it is important to use a safety mechanical anchorage system that may be visible or hidden. This system offers the following benefits:

- Greater impermeability and resistance against humidity and atmospheric agents.
- Lighter weight in comparison to façades made up of other materials.
- Minimum maintenance required.
- Energy efficiency gain.

La facciata incollata aumenta il valore estetico del rivestimento in porcellanato di alta qualità, con altri vantaggi come la leggerezza, una grande resistenza agli agenti chimici ed atmosferici, creando edifici con finiture innovative e durature nel tempo. Attualmente ci sono adesivi che permettono di migliorare l'incollaggio del materiale sulla facciata ma per garantire la sicurezza contro eventuali distaccamenti delle mattonelle stesse sono stati progettati sistemi di fissaggio con ancoraggio meccanico a vista o a scomparsa.

### VANTAGGI:

- Migliore isolamento contro l'umidità e resistenza agli agenti atmosferici.
- Aumento impermeabilità.
- Meno peso rispetto ad altre facciate installate con altri materiali.
- Manutenzione minima.

La fachada pegada incrementa el valor estético del revestimiento porcelánico de alta calidad, con otros aspectos, como la ligereza y un gran comportamiento ante agentes químicos y atmosféricos, dotando a los edificios de un acabado innovador y perdurable en el tiempo. En la actualidad, existen adhesivos que nos permiten mejorar el aplacado en la fachada. Pero para garantizar la seguridad de la misma ante posibles desprendimientos de las baldosas, se han diseñado sistemas de fijación con anclaje mecánico oculto y visto para su colocación.

### VENTAJAS:

- Mejor comportamiento frente a la humedad y los agentes atmosféricos.
- Mayor impermeabilidad.
- Menor peso respecto a otras fachadas con otros materiales.
- Mínimo mantenimiento.

For pricing on grooved material for hidden system, please check with our commercial department. Precios de material ranurado para sistema oculto, consultar con el departamento comercial.

### AVERAGE QUANTITY ANCHORING / M2. CONSUMO MEDIO ANCLAJES / M2.

SIZE TILE	UNITS/M2
60x120 cm	3 units/m2
90x90 cm	3 units/m2
45x90 cm	5,5 units/m2
60x60 cm	6,5 units/m2
30x60 cm	12 units/m2

Variable depending on the project.  
Variable en función del proyecto.

### ANCHORING PRICES. PRECIOS ANCLAJES.

REFERENCES (inox)	JOINT approx. JUNTA aprox	PRICE. PRECIO unit.
Oculto U - 8	8 mm	G-5027
Visto U - 8	8 mm	G-5029
Oculto Z - 1	1 mm	G-5033
Visto Z - 1	1 mm	G-5037

The price includes staple, plug and screw.  
El precio incluye grapa, taca y tornillo.



U-8 basic  
U-8 continuación



U-8 / Z-1 ending  
U-8 / Z-1 terminación



Z-1 basic  
Z-1 continuación

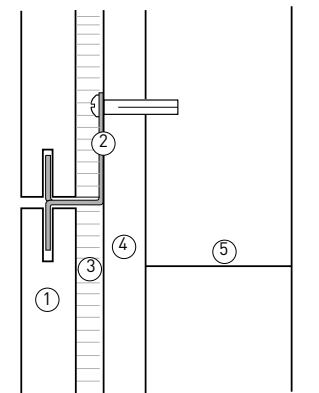

1. Porcelain tile. Porcelánico.
2. Unvisible mechanical anchorage. Anclaje mecánico oculto.
3. Adhesive. Adhesivo.
4. Mortar. Mortero.
5. Solid brick. Ladrillo macizo.



CONSORCI SANITARI GARRAF  
Barcelona. (SPAIN)  
PIETRA SERENA Collection

GLUED FAÇADE. FACHADA APLACADA CON GRAPA OCULTA

## INTERIOR RAISED FLOORS. PAVIMENTI SOPRAELEVATI INTERNI. PAVIMENTO SOBREELEVADO INTERNO.



The Raised Floor system for interior spaces is a technical solution for new buildings and refurbishments that will raise the functional floor surface from the floor substrate in order to offer the following advantages:

- Flexibility in the distribution of the spaces, as the panels can be easily removed and re-positioned.
- Practicality in maintenance operations as the panels can be lifted to reach all technical elements beneath.
- Versatility as the raised floor can also be positioned over a pre-existing floor and can be used to level surfaces with different heights.
- Aesthetic qualities as this surface guarantees excellent maintainance and durability over time.

This system is composed of two main elements: the panel and its support structure. The panel, is made by gluing a finishing slab of porcelain onto a 3-4 cm support. It is supported by a metallic frame consisting of crossbeams and adjustable pedestal for height adjustment giving a void space between floor substrate and the functional surface. In the technical space concealed between the substrate and the floor, any type of technical plant or equipment can be housed. The minimum height of the floor with respect to the support surface varies from 7 to 8 cm, so the solution of the raised floor can also be adapted to pre-existing floors.



Il pavimento sopraelevato si compone di due elementi principali: il pannello e la sua struttura di sostegno. Il pannello, è il risultato dell'incollaggio di un supporto di 3-4 cm con una lastra di finitura in gres. La lastra costituisce il piano di calpestio, garantendo qualità estetiche ed eccellenti caratteristiche di pulibilità, inalterabilità e resistenza nel tempo. Nello spazio tecnico nascosto tra il fondo e il pavimento è possibile alloggiare qualsiasi tipo di impianti e servizi. L'altezza minima della pavimentazione rispetto al piano d'appoggio varia dai 7 agli 8 cm, per cui la soluzione del pavimento sopraelevato si può adattare anche al caso di pavimenti preesistenti. Il materiale porcelanico dovrebbe essere di formato 59,55x59,55 cm.

### VANTAGGI:

- Praticità nelle operazioni di manutenzione grazie all'accessibilità degli impianti.
- Flessibilità nella distribuzione degli ambienti e nella loro successiva rimodulazione.
- Versatilità. Il pavimento sopraelevato può essere posizionato anche su un pavimento preesistente e può essere utilizzato per raccordare piani con altezze diverse.
- Possibilità di riutilizzo. La posa a secco senza l'uso di collanti permette la movimentazione dei singoli pannelli o di tutta la pavimentazione in ambienti diversi da quelli iniziali.

El sistema de suelo sobreelevado técnico está compuesto por dos elementos principales: el panel y su estructura de apoyo. El panel, se realiza pegando la pieza de porcelánico sobre un soporte de 3-4 cm. La pieza va montada sobre una marco metálico con unos travesaños y unos pedestales de altura ajustable para dejar un espacio vacío entre el suelo y la superficie de tránsito. El porcelánico constituye esta superficie transitable, para garantizar la calidad estética, la facilidad de limpieza, inalterabilidad y durabilidad en el tiempo. Cualquier tipo de conexiones o equipos pueden ser alojados en el espacio oculto entre el substrato y la superficie. La altura mínima de la suelo con respecto a la superficie de soporte varía de 7 a 8 cm, por lo que la solución de suelo elevado también puede adaptarse a pavimentos ya existentes. El material porcelánico a utilizar en la parte superior debe ser de formato 59,55x59,55 cm.

### VENTAJAS:

- Accesibilidad. Facilidad en el mantenimiento debido al fácil acceso al espacio entre suelo y pavimento.
- Flexibilidad en la distribución de los espacios y remodulación, por la facilidad de sacar las piezas y moverlas a otra posición.
- Versatibilidad. El suelo sobreelevado puede ser colocado sobre un piso ya existente y se puede utilizar para unir superficies de diferentes alturas.
- Posibilidad de reutilización. La colocación de las capas de suelo sin uso de adhesivo ofrece la posibilidad de cambio de ubicación de algunas piezas o del suelo entero.

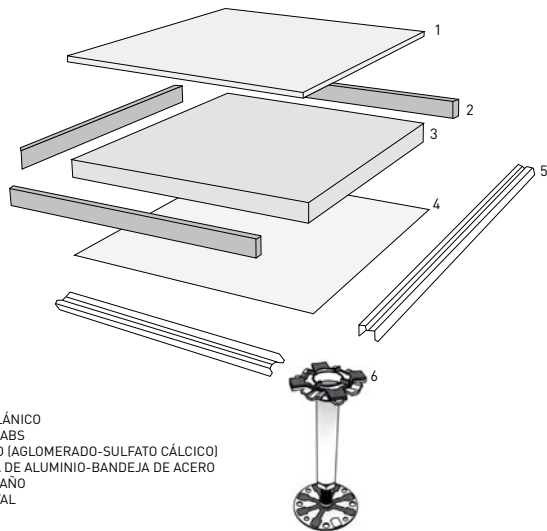

1. PORCELÁNICO
2. PERFIL ABS
3. NÚCLEO [AGLOMERADO-SULFATO CÁLCICO]
4. LÁMINA DE ALUMINIO-BANDEJA DE ACERO
5. TRAVESAÑO
6. PEDESTAL

## EXTERIOR RAISED FLOORS. PAVIMENTI SOPRAELEVATI ESTERNI. PAVIMENTO SOBREELEVADO EXTERNO.

The Exterior Raised Flooring system offers the possibility of having flat paved surfaces suitable for traffic in outdoor areas that may or may not have slopes (up to a 3% inclination). At the same time, it offers a ventilated cover with perfect drainage of the paved surface performing the filtration of water through the joints between tiles as well as better maintenance and greater insulation. This system of an easy installation is formed by 20mm tiles (either one individual piece of 20mm or two pieces of 10mm glued together), placed on a support base that are the PLOTS, made of polypropylene. With these, it is possible to create a space between the tiles and the surface, which can be on a rooftop or a terrace, and that will be used for passage of pipes. The tiles can be easily moved around without losing any stability. There are two types of plots: fixed (15 mm height) for flat areas or adjustable (from 65 mm to 310 mm height) to solve any levelling issues in outdoor areas.

I pavimenti calpestabili sopraelevati da esterno sono costituiti da una piastrella di dimensioni standard (2 pezzi incollati) installata su di una base in polipropilene chiamato PLOTS al fine di creare uno spazio, chiamato plenum, tra essa e la superficie, che può essere un tetto o terrazzo, e che può essere utilizzato per il passaggio di tubi. Possiamo quindi ottenere superfici piane pavimentate adatte al calpestio con pendenze (sempre inferiori al 3%) con il vantaggio di una più facile manutenzione ed una maggiore coibentazione. Le pezzi possono essere sostituiti e scambiati con altri sistemi senza perdita di stabilità. Qualsiasi formato dei modelli di porcellana di questo catalogo può essere utilizzato per questo sistema. È possibile ottenere una copertura ventilata con un perfetto drenaggio eseguendo solo il recupero delle acque creato dalle fughe tra le piastrelle. Staffe fisse in polipropilene (altezza 15 mm) o regolabili (da 65 mm a 310 mm di altezza) completano il sistema adatto a risolvere tutte le soluzioni di pavimenti esterni sopraelevati.

Los pavimentos transitables elevados para exteriores, están formados por baldosas de una medida standard (2 piezas pegadas), instaladas sobre unas bases, denominadas PLOTS de polipropileno, para crear un espacio entre éste y la superficie, que puede ser una azotea o terraza exterior, llamado plenum que puede ser utilizado para paso de canalizaciones. De este modo conseguimos superficies pavimentadas planas y aptas para el tránsito sobre suelos con pendientes (siempre inferiores al 3%), con la ventaja de un mejor mantenimiento y un mayor aislamiento térmico. Para este sistema se puede utilizar cualquier formato de los modelos de porcelánico del catálogo. Se consigue una cubierta ventilada, con un perfecto drenaje de la superficie pavimentada, realizándose la filtración del agua por las juntas entre baldosas. Las piezas se pueden sustituir e intercambiar por otras del sistema sin pérdida de estabilidad. Los soportes fijos (de 15 mm alto) o regulables (desde 65 mm a 310 mm) en polipropileno completan el sistema, apto para resolver todas las soluciones de sobreelevaciones para exteriores.



TECHNICAL SOLUTIONS

### AVERAGE QUANTITY PLOTS / M2. CONSUMO MEDIO PLOTS / M2.

SIZE TILE	PLOTS/M2
60x120 cm	3 units/m2
90x90 cm	5,5 units/m2
22,5x90 cm	11 units/m2
45x90 cm	5,5 units/m2
60x60 cm	3 units/m2
30x60 cm	6 units/m2

Variable depending on the project.  
Variable en función del proyecto.

### PLOTS PRICES. PRECIOS PLOTS.

REFERENCES	HEIGHT ADJUSTMENT. REGULACIÓN ALTURA	UNIT PRICE. PRECIO UNITARIO	ALLOWABLE LOAD. CARGA ADMISIBLE
PLOT SNR 15	15 mm (fix. fija)	G-5039	6000 kg
PLOT SR 65/100	de 65 a 100 mm	G-5075	2500 kg
PLOT SR 100/130	de 100 a 130 mm	G-5079	2500 kg
PLOT SR 130/220	de 130 a 220 mm	G-5085	2200 kg
PLOT SR 220/310	de 220 a 310 mm	G-5100	2000 kg

For pricing on 2cm glued tiles please check with the commercial department.  
Precio doble pieza pegada, consultar con el departamento comercial.

Numéro de décision: 594/804-0.0/14 du 09 janvier 2015

## Liste des carreaux GRÈS PRESSÉ NON ÉMAILLÉ - Groupe: Bla

Série commerciale : **AZULCASCAIS NATURAL**

Particularité : Décorés - Option glissance non revendiquée

Comportement au gel : Satisfaisant selon essai normalisé

Dimensions	Epaisseur	Particularité	Coloris	Classement
595.5 x 595.5	10.3	Rectifié	Ivory	U4 P4+ E3 C2
595.5 x 595.5	10.3	Rectifié	Moss	U4 P4+ E3 C2

Série commerciale : **CIVIC**

Particularité : Option glissance non revendiquée

Comportement au gel : Satisfaisant selon essai normalisé

Dimensions	Epaisseur	Particularité	Coloris	Classement
595.5 x 595.5	10.3	Rectifié	Antracita	U4 P4+ E3 C2
595.5 x 595.5	10.3	Rectifié	Grey	U4 P4+ E3 C2
595.5 x 595.5	10.3	Rectifié	Ivory	U4 P4+ E3 C2

Série commerciale : **GALLERY POLI**

Particularité : Option glissance non revendiquée

Comportement au gel : Satisfaisant selon essai normalisé

Dimensions	Epaisseur	Particularité	Coloris	Classement
297.5 x 595.5	9.0	Rectifié	Blue	U3 P3 E3 C2
297.5 x 595.5	9.0	Rectifié	Lime	U3 P3 E3 C2
297.5 x 595.5	9.0	Rectifié	Orange	U3 P3 E3 C2
297.5 x 595.5	9.0	Rectifié	White	U3 P3 E3 C2

Série commerciale : **PIETRA SERENA NATURAL**

Particularité : Décorés - Option glissance non revendiquée

Comportement au gel : Satisfaisant selon essai normalisé

Dimensions	Epaisseur	Particularité	Coloris	Classement
595.5 x 595.5	10.3	Rectifié	Beige	U4 P4+ E3 C2
595.5 x 595.5	10.3	Rectifié	Graphite	U4 P4+ E3 C2
595.5 x 595.5	10.3	Rectifié	Ivory	U4 P4+ E3 C2
595.5 x 595.5	10.3	Rectifié	Moss	U4 P4+ E3 C2

Per toute information concernant les données techniques sur la classification UPEC, nous vous prions de bien vouloir consulter la version française de site [www.landporcelanico.com](http://www.landporcelanico.com)

# SLIP RESISTANCE. PROPRIETÀ ANTISCIVOLO. RESBALADICIDAD.

## DIN 51130 \*

(Average angle of acceptance)

(Ángulo de aceptación medio)

R9	R10	R11	R12
6°-10°	10°-19°	19°-27°	27°-35°
<ul style="list-style-type: none"> <li>• Austral</li> <li>• Azulcascais natural</li> <li>• Celtic</li> <li>• Civic natural</li> <li>• Dagon natural</li> <li>• Gallery satinado</li> <li>• Ismo natural</li> <li>• Jamtland natural</li> <li>• Jerusalem natural</li> <li>• Matter natural</li> <li>• Mensa natural</li> <li>• Midland natural</li> <li>• Origin natural</li> <li>• Pietra Serena natural</li> <li>• Portland natural</li> </ul>	<ul style="list-style-type: none"> <li>• Azulcascais natural</li> <li>• Kankare natural</li> <li>• Legno</li> <li>• Matter lappato</li> <li>• Nouveau natural</li> <li>• Portland lappato</li> <li>• Rambla natural</li> <li>• Warm natural</li> </ul>	<ul style="list-style-type: none"> <li>• Mensa non slip</li> <li>• Midland corrugato</li> <li>• Pietra Serena filosega</li> <li>• Pietra Serena rigato</li> <li>• Roots</li> </ul>	<ul style="list-style-type: none"> <li>• Azulcascais estructurado</li> <li>• Pietra Serena bocciardato</li> </ul>

## UNE-ENV 12633 \*

(ENSAYO DEL PÉNDULO) Clasificación de los suelos según la norma.

CLASE 1	CLASE 2	CLASE 3
15<Rd<35	35<Rd<45	Rd > 45
<ul style="list-style-type: none"> <li>• Austral</li> <li>• Azulcascais natural</li> <li>• Celtic</li> <li>• Civic natural</li> <li>• Dagon natural / lappato</li> <li>• Gallery satinado</li> <li>• Ismo natural / lappato</li> <li>• Jamtland natural / lappato</li> <li>• Jerusalem natural</li> <li>• Kankare natural</li> <li>• Legno</li> <li>• Matter natural</li> <li>• Mensa natural</li> <li>• Midland natural</li> <li>• Nouveau natural/lappato</li> <li>• Origin natural / lappato</li> <li>• Pietra Serena natural / lappato</li> <li>• Portland natural</li> </ul>	<ul style="list-style-type: none"> <li>• Matter lappato</li> <li>• Portland lappato</li> <li>• Rambla natural</li> </ul>	<ul style="list-style-type: none"> <li>• Azulcascais estructurado</li> <li>• Mensa non slip</li> <li>• Pietra Serena bocciardato</li> <li>• Pietra Serena filosega</li> <li>• Pietra Serena rigato</li> <li>• Roots</li> <li>• Midland corrugato</li> </ul>

ANTISLIP PROPERTIES

\* Theoretical classification. For projects, check the values given above, with our commercial network before ordering. For any further tests required, contact us.

\* Classificazione teorica. Per i progetti, verificare i valori di sopra, prima della conferma dell'ordine con la nostra rete commerciale.

\* Clasificación teórica. Consultar con nuestra red técnico-comercial los valores indicados antes de la confirmación del pedido para proyectos.

Ensayos realizados en laboratorio interno. / Tests realized in internal laboratories

CTE CÓDIGO TÉCNICO DE LA EDIFICACIÓN	USO PRIVADO			USO PÚBLICO
	Interior seco	Interior húmedo	Exterior	Edificios públicos (hospitales, gimnasios,...)
CLASE 1	Pendiente < 6%	—	—	—
CLASE 2	Pendiente ≥ 6% Escaleras	Pendiente < 6%	—	Interiores cubiertos
CLASE 3	—	≥ Pendiente 6% Escaleras	- Piscinas - Duchas - Terrazas	- Hall entrada - Terraza - Vestuario / baño - Cocina - Sala instalaciones / maquinaria

Fuente: Código Técnico de la Edificación / DB-SUA-Seguridad de Utilización y Accesibilidad / 1.1. Seguridad frente a caídas.

# CERTIFICATES. CERTIFICAZIONI. CERTIFICADOS.

LAND PORCELANICO carries out laboratory tests to set the technical characteristics of each one of its products (measurements and surfaces appearance) and certify that it applies the current norms.

LAND PORCELANICO effettua test di laboratorio per verificare che siano rispettate le caratteristiche tecniche di ciascuno dei propri prodotti (misurazioni e aspetto superficiale) e certifica che questi siano conformi alle norme attuali.

LAND PORCELANICO realiza ensayos de laboratorio para determinar las características técnicas de cada uno de sus productos (medidas y aspecto superficial) y certificar que se cumple con la normativa vigente.

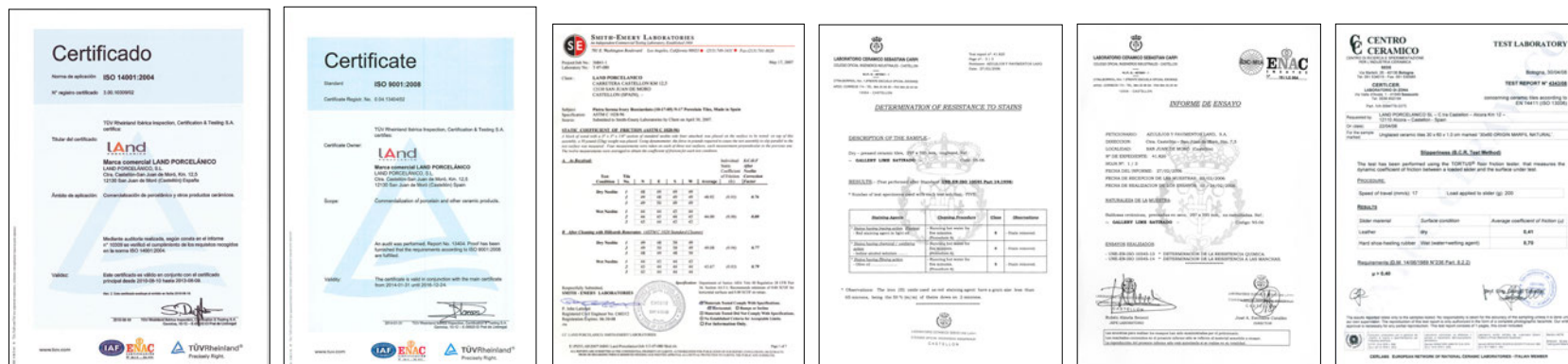

## CERTIFICATE ISO 14001: 2004

Environmental manage system

Sistema de gestión ambiental

## CERTIFICATE ISO 9001: 2008

Certifications issued for LAND PORCELANICO materials by the following official bodies:

Certificazioni rilasciate per il prodotto LAND PORCELANICO dai seguenti organismi ufficiali:

Certificados emitidos para el producto de LAND PORCELANICO por los siguientes organismos oficiales:



COMPLIANCE WITH CREDITS FOR

**LEED**  
CERTIFICATION SYSTEM

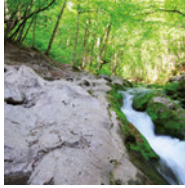

YOU CAN OBTAIN UP TO **38 LEED CREDITS**. SE PUEDEN OBTENER HASTA 38 **CRÉDITOS LEED**

depending on the following criteria:  
dependiendo de los siguientes criterios:

**DIRECT CREDITS**

**SUSTAINABLE SITES:**

- SS 1/7** HEAT ISLAND EFFECT. EFECTO ISLA DE CALOR
- SS 3** LOCAL HEAT ISLAND EFFECT. EFECTO ISLA DE CALOR LOCAL

**1-2**  
CREDITS

**MATERIALS AND RESOURCES:**

- MR** RECYCLED CONTENT. CONTENIDO RECICLADO
- MR** REGIONAL MATERIALS. MATERIALES REGIONALES
- MR** SUSTAINABLE PURCHASING. ADQUISICIÓN SOSTENIBLE
- MR** SUSTAINABLY SOURCED MATERIALS & PRODUCTS. PRODUCTOS Y MATERIAS PRIMAS SOSTENIBLES
- MR** ENVIRONMENTALLY PREFERABLE PRODUCTS. PRODUCTOS AMBIENTALMENTE PREFERIBLES

**0,5-8**  
CREDITS

**INDOOR ENVIRONMENTAL QUALITY**

- IEQ** LOW EMITTING MATERIALS. PRODUCTOS DE BAJA EMISIÓN

**1-4**  
CREDITS

**INDIRECT CREDITS**

**ENERGY & ATMOSPHERE**

- EA PR2** MINIMUM ENERGY PERFORMANCE. EFICIENCIA ENERGÉTICA MÍNIMA
- EA CR1** OPTIMIZE ENERGY PERFORMANCE. OPTIMIZACIÓN ENERGÉTICA

**1-21**  
CREDITS

**MATERIALS AND RESOURCES**

- MR CR1.2** BUILDING REUSE. REUTILIZACIÓN DEL EDIFICIO
- MR CR3** MATERIALS REUSE. REUTILIZACIÓN DE MATERIALES

**1-2**  
CREDITS

**INDOOR ENVIRONMENTAL QUALITY**

- IEQ CR3** CONSTRUCTION INDOOR AIR QUALITY MANAGEMENT PLAN. PLAN DE GESTIÓN DE LA CALIDAD DE AIRE INTERIOR

**1**  
CREDIT

CoverLEED | jtc | Land

**CERTIFICATE**  
**ISO 14001: 2004**

Environmental manage system  
Sistema de gestión ambiental



**INTEGRATED ENVIRONMENTAL AUTHORIZATION** (issued by The Center for Climate Change, at the Environment, Water and Urban Development Council of Comunidad Valenciana, according to a resolution dated 28th of November, 2007. 2008/1866).

**AUTORIZACIÓN AMBIENTAL INTEGRADA** (otorgada por la Dirección General para el Cambio Climático, de la Conselleria de Medio Ambiente, Agua, Urbanismo y Vivienda de la Comunidad Valenciana, según resolución del 28 de Noviembre de 2007. 2008/1866).



## ADVICES FOR FIXING PORCELAIN TILES. CONSIGLI PER LA POSA DEL GRES PORCELLANATO. CONSEJOS PARA LA COLOCACIÓN DEL PORCELÁNICO.



COCA - COLA OFFICES  
Rattingen. (GERMANY)  
Arch. RKW ARCHITEKTUR / STADTEBAU

**TILING.** The support base for wall or floor for the tiles must be stable, dry, flat and it must have the adequate consistency. This base must never be too hot nor too cold and should be clean. One must not forget to clean any dust, grease or oil leftovers to facilitate an optimal adhesion. It is convenient to use slightly rough support bases, altering any excessively smooth leveling layer, in order to ensure great adherence.

**ACONDICIONAMIENTO DEL FONDO.** El fondo o soporte para pared o suelo sobre el que se colocarán las baldosas debe estar estable, seco, y limpio sin restos de polvo, grasa o aceite. Es conveniente disponer de soportes rugosos alterando los soportes excesivamente lisos o la propia capa de nivelación ligeramente para garantizar mayor adhesión.

**FIXER MATERIALS TO USE.** The type of adhesive will be determined by the water absorption of each type of tile. In our case, it is advisable to employ the technique of placing a thin layer of cement adhesive of type C2. For formats larger than 30x30cm, we recommend to double-layer-adhesive. This technique involves the appliance of adhesive on the support base as well as on the tile; this technique is strongly recommended for outdoors.

The bonding material must be applied with serrated edged comb to achieve a homogenous adhesive distribution throughout the laying surface, even in the corners of the tile. A non-uniform adhesive layer will cause tensions on the tile, which will create an "eyebow" effect. It is advisable to follow the instructions of the adhesive manufacturer, particularly for different cement-based bonding materials.

**ADHESIVOS A EMPLEAR.** La elección del tipo de adhesivo vendrá determinada por la absorción del agua de cada tipo de baldosa. En nuestro caso, se aconseja emplear la técnica de colocación en capa fina con el uso de Adhesivos Cementosos tipo C2. Para grandes formatos superiores a 30x30cm, se recomienda la técnica de colocación de doble encolado, esto es, aplicar adhesivo sobre el soporte y en la baldosa, en especial en exteriores. El material de agarre debe aplicarse con una llana dentada para conseguir una distribución del adhesivo homogénea por toda la superficie de colocación incluso en las esquinas de la baldosa, presionando la baldosa sobre el adhesivo todavía fresco. De no ser uniforme la capa de adhesivo provocará tensiones en la baldosa que generan a la larga el efecto "ceja".

**FIXING.** The previous handling of the tiles, especially the rectified, must be done with utmost care to avoid scratches or chipping of the tiles. During the fixing process, the surface shall not be marked by graphite materials (pencils) or permanent markers, especially in the case of polished products to avoid potential cleaning problems.

In the placement of tiles the use of at least 2mm spreaders is advisable. For locked placement, it is advisable to fix at a distance from 1/3 of the piece, never at half of the piece. In large format porcelain pieces (over 60cm of any of its sides) it is convenient to use leveling clips to ensure the flatness of the pieces.

**COLOCACIÓN.** La manipulación previa de las baldosas, en especial las rectificadas, ha de realizarse en el máximo cuidado, para evitar despuntados, rayas o desconchados en su superficie. Durante la colocación, no deberá marcarse la superficie de utilización con lápices (grafito) o rotuladores indelebles, especialmente en el caso de los productos pulidos para evitar posibles problemas de limpieza de los mismos. En la colocación de las baldosas se recomienda el uso de cruceas de al menos 2mm. En colocación trabada es aconsejable la colocación a una distancia de 1/3 de la pieza, nunca a la mitad de la pieza. En pavimentos de grandes formatos (mayores de 60cm en alguno de sus lados) es conveniente el uso de un sistema de nivelación para garantizar la planitud de las piezas (disponibles en el mercado de varios fabricantes).

# ADVICES FOR CLEANING PORCELAIN TILES. CONSIGLI PER LA PULIZIA DEL GRES PORCELLANATO. CONSEJOS PARA LA LIMPIEZA DEL PORCELÁNICO.

**ASSEMBLY JOINTS AND EXPANSION.** The main functions of installation joints are: to absorb deformations of the support, to increase surface adhesion between the parts and the bonding material, and to improve the impermeability of the surface. It is necessary to respect the indications given below:

- Structural joints: the construction project already takes into account the existence of these joints in the floor coverings. These must also abide when covering the joint with plastic trims.
- Perimeter joints: it is always appropriate to provide these joints that insulate the tile and bonding material from any structural movements, avoiding tensions with them. Perimeter joints are normally hidden by the skirting board or the tile itself; they must have a width of 5 to 10 mm, and may be empty or filled with deformable material.
- Expansion joints: allow deformations due to thermal and hygroscopic variations between tiles, the bonding material and the support base. Usually designed with a width of 5-8 mm and surfaces from 25m<sup>2</sup> (in sections of 5x5 m<sup>2</sup>) indoors, and from 9m<sup>2</sup> outdoors. These joints must be well executed, this means that they must be flexible, waterproof, well bonded and must reach the base support.
- Installation joints: those between tiles. Before grouting these must be empty, without any bonding materials. It is not recommended to fix any floor without joints, advising a minimum joint of 2-3 mm. The grout used in installation joints must be applied with a rubber float. The market offers a wide range of grouts, which are suitable for each type of tile and temperature as specified by the manufacturer of the grout, in which the type of product to be used, colors and waiting time before grouting should be recommended.

Before grouting, it is advisable to test a small area of the part to determine whether the chosen grout affects or stains the surface of the piece. In this case, one should contact the grout manufacturer. Ask the manufacturer for a suitable cleaner for this type of grip material. A bonding material with a thin granulometry is desirable in order to avoid scratches on the tile during its placement.

**JUNTAS DE COLOCACIÓN.** Las principales funciones de las juntas de colocación son: absorber las deformaciones del soporte, aumentar la adhesión de superficie entre las piezas y el material de agarre, y mejorar la impermeabilidad de la superficie. Es conveniente respetar las indicaciones dadas a continuación:

- Juntas estructurales: el proyecto de construcción ya tiene en cuenta la existencia de estas juntas en los revestimientos para el suelo. Estos también deben atenerse a cubrir la junta con embellecedores de plástico.
- Las juntas perimetrales: siempre es apropiado para prever estas juntas que aíslan la baldosa y al adhesivo de los movimientos estructurales, evitando tensiones con ello. Las juntas perimetrales quedan normalmente ocultas por el rodapié o el propio azulejo; deben tener una anchura de 5 a 10 mm, y pueden quedar vacías o llenas de material deformable.
- Juntas de expansión: permiten deformaciones debidas a las variaciones térmicas e higroscópicas entre las baldosas, el adhesivo y el soporte. Normalmente se diseñan con una anchura mínima de 5-8 mm y en superficies a partir de 25m<sup>2</sup> (en paños de 5x5 m<sup>2</sup>) en interiores, y en superficies a partir de 9m<sup>2</sup> en exteriores. Estas juntas deben estar bien ejecutados, esto significa que deben ser flexibles, impermeables, estar bien adheridas y deberán llegar a el soporte base.
- Las juntas de colocación: son las existentes entre baldosa y baldosa. Antes del rejuntado éstas debe estar vacías. Se desaconseja una colocación a junta unida o a "testa", aconsejándose una junta mínima de 2-3mm. El material de rejuntado utilizado en juntas de colocación se debe aplicar con una llana de goma. El mercado ofrece una amplia gama de materiales de rejuntado, que se adecuan a cada tipo de baldosa y ambiente según especificaciones del fabricante del material de rejuntado, en las que se debe recomendar el tipo de producto a utilizar, los colores y el tiempo de espera hasta el comienzo del rejuntado.

Antes del rejuntado, es conveniente probar en un área pequeña de la pieza para determinar si el rejunte elegido afecta o mancha de la superficie de la pieza, en cuyo caso, hay que ponerse en contacto con el fabricante del material de rejuntado. Pregunte al fabricante por un limpiador adecuado para este tipo de material. Es recomendable que la granulometría del material de rejuntado sea fina con el fin de evitar arañazos y rayas en la baldosa durante su colocación.

**CLEANING AFTER INSTALLATION.** The most important cleaning operation is performed immediately after laying the tiles. This involves the complete removal of residues and dirt from the tile placement. An inadequate or late removal of this waste can create a cementitious layer on the tile capable of absorbing all forms of dirt. This may give the impression that the tile gets dirty when the actual problem resides in the surface film of dirt which was not removed immediately after laying.

Once the grouting of the tiles is finished, it is important, while the grout is still wet, to carefully remove any excess material immediately. This can be done using a sponge and plenty of clean water, repeating this as many times as necessary.

Do not perform the cleaning with metal tools, scrapers or abrasive pads. For stubborn stains, clean with alcohol and lukewarm water and rub with a clean cloth. If they do not disappear, check with the relevant technical department.

Once the above mentioned washing is done, another washing should be carried out using basic or alkaline degreasing agents, as acid washing can leave stickiness on the pavement which could help retain dirt. In areas where water is calcareous, it is convenient to dry the surface, in order to prevent the deposition of carbonates which will reduce the surfaces' gleam.

**LIMPIEZA DESPUÉS DE LA COLOCACIÓN.** La operación de limpieza más importante se realiza inmediatamente después de colocar las baldosas. Esto implica la eliminación completa de los residuos y la suciedad de la colocación de las propias baldosas. Una eliminación inadecuada o tardía de estos residuos puede crear sobre la baldosa una película cementosa capaz de absorber toda forma de suciedad, dando la impresión de que las baldosas se ensucian cuando el problema real reside en la película superficial de suciedad.

Una vez terminado el rejuntado de las baldosas, es importante quitar cuidadosamente cualquier exceso de material inmediatamente mientras el esté todavía húmedo. Esto se puede hacer con una esponja y abundante agua limpia, repitiendo esta operación tantas veces como sea necesario.

No realizar la limpieza con herramientas de metal, rascadores o esponjas abrasivas. Para las manchas difíciles, limpiar con alcohol y agua tibia y frotar con un paño limpio. Si no desaparecen, consulte con el departamento técnico correspondiente.

Una vez efectuado el lavado descrito arriba, deberá efectuarse un nuevo lavado utilizando detergentes desengrasantes básicos o alcalinos, ya que el lavado ácido puede dejar untuosidad en el pavimento, que podría ayudar a retener la suciedad. En las zonas donde el agua es calcárea, es conveniente secar la superficie, con el fin de evitar la deposición de carbonatos que reducirán el brillo superficial.

## \* Physical Vapor Deposition (PVD)

Pvd is a field in the application of nanotechnology. The process consists of depositing layers of atoms, inside a vacuum chamber, to a solid surface. The layering is produced by the condensation of a vaporized metal (such as gold, titanium, platinum etc.) over the selected surface.

Advantages: Resistance to abrasion and scratches; much higher than metals applied by firing. Corrosion resistant. ISO 9227. As a general rule, any non-aggressive, pH neutral product can be used.

Do not mix pieces from different lots.

## DIGITAL PRINTING. STAMPA DIGITALE. IMPRESIÓN DIGITAL.



The digital printing system is a process of decorating ceramic pieces using an ink-jet application to enable the development of high quality photo reproductions (including images, drawings, text, logos, etc...), maintaining the high technical characteristics of our ceramic products.

With our special decoration system, as a result, we can offer pieces of a greater realism due to the fact that it can achieve higher printing resolutions.

Another advantage of this system is the ecological aspect, since by using only four colors (CMYK), the number of materials used in the production are substantially reduced, thereby reducing the extraction of these materials and its environmental impact.

Il sistema di stampa digitale è un processo di decorazione di pezzi ceramici che si effettua mediante l'applicazione di iniezioni (CMYK) che consentono lo sviluppo di parti con riproduzioni fotografiche in alta definizione (tra cui immagini, disegni, testi, loghi, ecc...), mantenendo le elevate prestazioni del nostro prodotto ceramico.

Con questo processo di decorazione digitale si ottiene un maggiore realismo della foto o disegno stampato sul pezzo, e si può ottenere una risoluzione di stampa più elevata di quella raggiunta finora.

Un altro vantaggio di questo sistema è l'aspetto ecologico, poiché utilizzando quattro colori (CMYK) diminuisce sostanzialmente il numero di materiali utilizzati nella produzione, riducendo così il loro smaltimento e l'impatto ambientale.

El sistema de impresión digital es un proceso de decoración de piezas cerámicas, mediante una aplicación de inyección (CMYK) que posibilita el desarrollo de piezas con reproducciones fotograficas en alta calidad (ya sean imágenes, dibujos, textos, logotipos,..etc), manteniendo las elevadas prestaciones de nuestro producto cerámico.

Con este proceso digital de decoración se consigue un mayor realismo en la fotografía o dibujo impresa en la pieza, ya que se pueden obtener unas resoluciones más altas de impresión que las conseguidas hasta ahora.

Otra de las ventajas de este sistema es el aspecto ecológico, ya que al utilizar 4 colores (CMYK) se reducen sustancialmente el número de materiales utilizados en producción, reduciendo así la extracción de los mismos y su impacto medioambiental.

## WATERJET CUTTING. TAGLIO A GETTO D'ACQUA. CORTE DE AGUA.

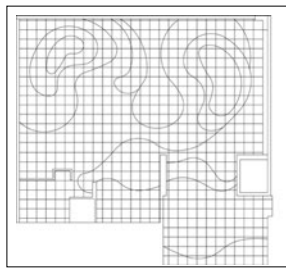

In order to create custom floor designs, usually including borders and center pieces, combining different collections we use the Water Jet system. The Water Jet system is based on a tool that is capable of slicing into porcelain tiles using a water jet at a high speed and pressure, or a mixture of water and an abrasive substances. The process is essentially the same as water erosion found in nature but accelerated and concentrated by orders of magnitude. Water Jet cutters are capable of producing rather intricate cuts in porcelain tiles, in other way impossible to obtain.

The advantages of this system go beyond the final visual results.

- More precise cuts, avoiding tears or unstructured shapes when handling the product.
- Allows precise cuts on thicker pieces with lower net weight.
- Enables any desired design to be manufactured according to what the client wants.

Una tagliapiastrelle a idrogetto è uno strumento capace di tagliare il porcellanato e altri materiali utilizzando unicamente un getto d'una miscela di acqua e sostanze abrasive ad alta pressione. Il processo è essenzialmente uguale a come avviene in natura con l'erosione delle acque, ma accelerato e concentrato. Il taglio a idrogetto è in grado di produrre intricate decorazioni altrimenti impossibili da effettuare.

I vantaggi di questo processo vanno al di là della semplice estetica.

- Il taglio è di migliore qualità e non produce deformazioni causate dallo sforzo o dall'aumento del calore.
- Consente tagli più sottili anche su superfici di grande spessore.
- Non produce inquinamento o gas a effetto serra.

Una cortadora por chorro de agua es una herramienta capaz de cortar porcelánico u otros materiales usando un chorro de una mezcla de agua y una sustancia abrasiva a alta velocidad y presión. El proceso es esencialmente el mismo que la erosión del agua produce en la naturaleza pero acelerado y concentrado en órdenes de magnitud. Las cortadoras por chorro de agua son capaces de producir intrincados cortes en el porcelánico, de otra forma imposibles de conseguir.

Las ventajas de este proceso van más allá de las meramente estéticas:

- El corte es de mejor calidad, ya que no produce desgarros ni deformaciones por esfuerzos de corte o aportación de calor.
- Permite cortes de mayor espesor y menor ancho de malla.
- No produce gases ni polución.



BAYSTONE BOUTIQUE HOTEL & SPA  
Grand Baie. MAURITIUS  
Arch: ALBERT ANGEL

# PACKING LIST. LISTA D'IMBALLO. LISTA DE EMBALAJE

				BOXES / EUROPALLET CASSE / EUROPALLET CAJAS / EUROPALLET	PIECES / BOX PEZZI / CASSA PIEZAS / CAJA	M <sup>2</sup> / BOX M <sup>2</sup> / CASSA M <sup>2</sup> / CAJA	SQUARE FEET / BOX PIEDI QUADRI / CASSA PIES CUADRADOS / CAJA	M <sup>2</sup> / EUROPALLET M <sup>2</sup> / EUROPALLET M <sup>2</sup> / EUROPALLET	SQUARE FEET / EUROPALLET PIE QUADRATI / EUROPALLET PIES CUADRADOS / EUROPALLET	KG / EUROPALLET KG / EUROPALLET KG / EUROPALLET	KG / BOX KG / CASSA KG / CAJA	L MTS / BOX METRI LINEARI / CASSA METROS LINEALES / CAJA	
	base 30x30	29,75x29,75 cm	11.71"x11.71"	40	13	1,150	12,38	46,00	495,14	1030	25,170	-	
	base 60x120	59,55x119,3 cm	23.45"x35.22"	50	1	0,710	7,64	35,50	382,12	965	18,840	-	
	base 60x120 slim	59,55x119,3 cm	23.45"x35.22"	30	2	1,421	15,29	46,63	501,92	530	16,9	-	
	base 30x120	29,75x119,3 cm	11.71"x35.22"	36	3	1,064	11,41	38,16	410,75	1027	27,885	-	
	base 20x120	19,71x119,3 cm	7.76"x35.22"	45	4	0,941	10,13	42,35	455,86	1167	25,410	-	
	base 15x120	14,74x119,3 cm	5.80"x35.22"	30	6	1,055	11,30	31,50	339,05	840	27,230	-	
	base 90x90	89,46x89,46 cm	35.22"x35.22"	36	1	0,800	8,61	28,80	310,00	812	21,910	-	
	base 90x90 slim	89,46x89,46 cm	35.22"x35.22"	20	2	1,601	17,22	32,02	620,00	585	27,597	-	
	base 45x90	44,63x89,46 cm	17.57"x35.22"	27	3	1,198	12,89	32,53	350,15	880	30,259	-	
	base 45x90 slim	44,63x89,46 cm	17.57"x35.22"	27	5	1,996	21,48	53,89	580,06	980	35,455	-	
	base 30x90 slim	29,75x89,46 cm	11.71"x35.22"	40	8	2,129	22,91	85,16	916,65	1150	28,170	-	
	base 30x90 slim	29,75x89,46 cm	11.71"x35.22"	40	7	1,863	20,05	74,52	802,13	1000	24,430	-	
	base rihe 30x90	29,75x89,46 cm	11.71"x35.22"	36	4	1,065	11,46	42,60	458,57	901	21,950	-	
	base 22,5x90	22,21x89,46 cm	8.75"x35.22"	36	5	0,993	10,69	35,75	384,81	940	25,470	-	
	base up	22,21x88,50 cm	8.75"x34.87"	36	3	0,596	6,41	21,46	230,99	276	7,040	-	
	base 15x90	14,74x89,46 cm	5.80"x35.22"	44	8	1,052	12,45	46,29	498,17	1163	25,900	-	
	base 15x90	14,74x89,46 cm	5.80"x35.22"	42	7	0,923	9,94	38,77	417,27	1012	23,560	-	
	base 15x90 slim	14,74x89,46 cm	5.80"x35.22"	26	6	0,789	8,49	20,51	220,76	522	19,42	-	
	base up	14,74x88,80 cm	5.80"x34.96"	30	5	0,655	7,05	19,65	211,51	530	16,890	-	
	Legno preincision irreg.	14,74x89,46 cm	5.80"x35.22"	42	7	0,923	9,94	38,77	417,27	1017	23,670	-	
	base hexagonal	51,57x59,55 cm	20.31"x23.45"	30	3	0,921	9,87	27,63	297,45	710	22,900	-	
	base 60x60	59,55x59,55 cm	23.45"x23.45"	30	3	1,063	11,45	31,89	343,26	780	25,233	-	
	base 60x60 slim	59,55x59,55 cm	23.45"x23.45"	30	5	1,773	19,08	53,19	572,53	950	30,898	-	
	base 30x60	29,75x59,55 cm	11.71"x23.45"	40	6	1,063	11,44	42,52	457,68	1050	25,667	-	
	base 30x60 slim	29,75x59,55 cm	11.71"x23.45"	40	8	1,417	15,25	56,68	610,09	1000	24,427	-	
	base pulido	29,75x59,55 cm	11.71"x23.45"	40	7	1,240	13,34	49,60	533,89	1050	25,677	-	
	base satinado	29,75x59,55 cm	11.71"x23.45"	40	7	1,240	13,34	49,60	533,89	1100	26,923	-	
	base righe	29,75x59,55 cm	11.71"x23.45"	40	6	1,063	11,44	42,52	457,68	1000	24,423	-	
	base artech	29,75x59,55 cm	11.71"x23.45"	40	6	1,063	11,44	42,52	457,68	1000	24,423	-	
	base eye	29,75x59,55 cm	11.71"x23.45"	16	4	0,709	7,63	11,34	122,11	331	19,267	-	
	base 45x45	44,63x44,63 cm	17.57"x17.57"	68	5	0,996	10,72	67,73	729,02	1570	22,750	-	
	preincision 7,5x90	22,21x89,46 cm	8.75"x35.22"	36	5	0,993	10,69	35,75	384,81	940	25,470	-	
	preincision 2,5x60	29,75x59,55 cm	11.71"x23.45"	16	7	1,240	13,35	19,84	213,56	453	26,867	-	
	preincision 3,5x60	29,75x59,55 cm	11.71"x23.45"	16	7	1,240	13,35	19,84	213,56	453	26,867	-	
	preincision 7,5x60	29,75x59,55 cm	11.71"x23.45"	16	7	1,240	13,35	19,84	213,56	453	26,870	-	
	preincision 15x60	29,75x59,55 cm	11.71"x23.45"	16	7	1,240	13,35	19,84	213,56	453	26,870	-	
	preincision irregular	29,75x59,55 cm	11.71"x23.45"	16	7	1,240	13,35	19,84	213,56	453	26,870	-	
	b-insert	29,75x59,55 cm	11.71"x23.45"	40	7	1,260	13,57	50,40	542,51	1161	28,449	-	
	módulo	29,75x59,55 cm	11.71"x23.45"	16	6	1,063	11,44	17,01	183,07	414	24,423	-	
	corte	29,75x59,55 cm	11.71"x23.45"	16	6	1,063	11,44	17,01	183,07	414	24,423	-	
	corte	29,75x29,75 cm	11.71"x11.71"	36	7	0,620	6,67	22,32	240,25	528	14,037	-	
	raised	44,63x44,63 cm	17.57"x17.57"	17	3	0,598	6,44	10,16	109,36	312	17,013	-	
	mosaico hex 3D	27,20x23,60 cm	10.71"x9.29"	32	5	0,320	3,45	10,24	110,23	271	8,019	-	
	mosaico 1,5x30	29,75x29,75 cm	11.71"x11.71"	36	7	0,620	6,67	22,32	240,25	474	12,520	-	
	mosaico 10x10 slim	29,75x29,75 cm	11.71"x11.71"	36	12	1,062	11,43	38,23	411,50	491	13,010	-	
	mosaico 2,5x2,5	29,75x29,75 cm	11.71"x11.71"	36	7	0,620	6,67	22,32	240,25	486	12,854	-	
	mosaico 2,5x2,5 slim	29,75x29,75 cm	11.71"x11.71"	36	12	1,062	11,43	38,23	411,50	491	13,010	-	
	mosaico 2,5x10	29,75x29,75 cm	11.71"x11.71"	36	7	0,620	6,67	22,32	240,25	486	12,854	-	
	mosaico 2,5x30	29,75x29,75 cm	11.71"x11.71"	36	7	0,620	6,67	22,32	240,25	486	12,854	-	
	mosaico 3,5x3,5	29,75x29,75 cm	11.71"x11.71"	36	7	0,620	6,67	22,32	240,25	486	13,854	-	
	mosaico 3,5x10	29,75x29,75 cm	11.71"x11.71"	36	7	0,620	6,67	22,32	240,25	486	12,854	-	
	mosaico 3,5x3,5 3D	29,75x29,75 cm	11.71"x11.71"	36	5	0,443	4,77	15,95	171,68	348	9,273	-	
	mosaico 3,5x15	29,75x29,75 cm	11.71"x11.71"	36	7	0,620	6,67	22,32	240,25	486	12,854	-	
	mosaico 5x5	29,75x29,75 cm	11.71"x11.71"	36	7	0,620	6,67	22,32	240,25	491	13,000	-	
	mosaico 5x5 slim	29,75x29,75 cm	11.71"x11.71"	36	7	0,620	6,67	22,32	240,25	491	13,000	-	
	mosaico 5x10	29,75x29,75 cm	11.71"x11.71"	36	10	0,885	9,52	31,86	342,93	868	18,415	-	

# PACKING LIST. LISTA D'IMBALLO. LISTA DE EMBALAJE

				BOXES / EUROPALLET CASSE / EUROPALLET CAJAS / EUROPALLET	PIECES / BOX PEZZI / CASSA PIEZAS / CAJA	M <sup>3</sup> / BOX M <sup>3</sup> / CASSA M <sup>3</sup> / CAJA	SQUARE FEET / BOX PIEDI QUADRI / CASSA PIES CUADRADOS / CAJA	M <sup>2</sup> / EUROPALLET M <sup>2</sup> / EUROPALLET M <sup>2</sup> / EUROPALLET	SQUARE FEET / EUROPALLET PIE QUADRATI / EUROPALLET PIES CUADRADOS / EUROPALLET	KG / EUROPALLET KG / EUROPALLET KG / EUROPALLET	KG / BOX KG / CASSA KG / CAJA	L MTS / BOX METRI LINEARI / CASSA METROS LINEALES / CAJA
	mosaico 7,5x7,5	29,75x29,75 cm	11.71"x11.71"	36	7	0,620	6,67	22,32	240,25	491	13,000	-
	modulo 15x15	29,75x29,75 cm	11.71"x11.71"	36	6	0,531	5,71	19,12	205,76	423,06	11,120	-
	muretto roots	29,75x59,55 cm	11.71"x23.45"	36	4	0,709	7,63	25,52	274,69	577,49	15,410	-
	mosaico 3D hex slim	29,75x29,75 cm	11.71"x11.71"	36	12	1,060	11,41	38,16	410,75	461,08	12,170	-
	mosaico 3D	28,5x28,5 cm	11.22"x11.22"	36	7	0,569	6,12	20,48	220,48	382,00	9,962	-
	mosaico 3D slim	44,63x44,63 cm	17.57"x17.57"	17	4	0,79	8,50	13,43	144,56	232,91	12,361	-
	decor	29,75x29,75 cm	11.71"x11.71"	36	7	0,620	6,67	22,32	240,25	528	14,037	-
	multicolor	29,75x29,75 cm	11.71"x11.71"	36	7	0,620	6,67	22,32	240,25	528	14,037	-
	mosaico sin fin	29,75x37,50 cm	11.71"x14.76"	32	7	0,620	5,59	16,61	178,80	472	14,037	-
	mosaico sin fin	33x33 cm	12.99"x12.99"	32	7	0,519	7,05	20,89	224,94	359	10,505	-
	muretto	14,87x29,75 cm	5.85"x11.71"	32	12	0,653	7,05	20,89	224,94	359	10,505	-
	muretto	14,87x29,75 cm	5.85"x11.71"	32	14	0,604	6,47	19,33	208,10	414	12,225	-
	muretto slim	14,87x29,75 cm	5.85"x11.71"	32	14	0,604	6,47	19,33	208,10	208	5,785	11,70
	listelo	7,3x89,46 cm	2.87"x35.22"	30	13	0,840	9,04	25,20	208,10	666	21,438	11,28
	listelo	7,3x59,55 cm	2.87"x23.45"	24	18	0,810	8,72	19,44	271,25	452	17,890	11,70
	listelo	4,8x59,55 cm	1.87"x23.45"	24	28	0,840	9,04	20,16	209,25	600	24,050	14,73
	listelo	3,5x59,55 cm	1.38"x23.45"	24	36	0,707	7,64	16,97	217,03	435	17,170	33,35
	listelo	2,3x59,55 cm	0.91"x23.45"	24	56	0,834	9,01	20,02	182,69	459	18,170	6,57
	listelo	7,3x44,63 cm	2.87"x17.57"	48	14	0,472	5,10	22,66	215,52	518	10,320	8,87
	listelo	7,3x29,75 cm	2.87"x11.71"	36	29	0,653	6,97	23,51	243,90	669	17,947	8,86
	listelo sin fin	29,75x37,50 cm	11.71"x14.76"	32	7	0,780	8,41	24,99	252,60	435	12,870	-
	inserto	R 12,8 cm	R 5"	36	14	0,720	7,76	25,92	269,01	316	8,150	-
	taco	14,8x14,8 cm	5.80"x5.80"	36	34	0,750	8,02	26,82	279,02	612	16,350	-
	taco	7,3x7,3 cm	2.87"x2.87"	144	30	0,169	1,82	18,25	288,69	562	3,740	-
	taco	2,3x2,3 cm	0.91"x0.91"	108	270	0,169	1,82	18,25	252,65	417	3,650	5,20
	chevron	14,8x89,46 cm	5.80"x35.22"	36	10	1,089	11,72	39,204	421,98	730	19,650	-
	cenefa-3 90	14,8x89,46 cm	5.80"x35.22"	26	6	0,790	8,54	20,54	196,44	530	19,500	-
	cenefa	4,3x89,46 cm	1.69"x35.22"	44	24	0,923	9,98	40,61	221,09	790	17,430	5,36
	cenefa-3	14,8x59,55 cm	5.80"x23.45"	24	9	0,810	8,72	19,44	437,12	450	17,800	17,50
	cenefa-1	9,6x59,55 cm	3.84"x23.45"	24	14	0,840	9,04	20,16	209,25	466	18,450	5,06
	cenefa	14,8x29,75 cm	5.80"x11.71"	36	17	0,750	8,06	26,96	217,02	621	16,599	12,50
	arbois cenefa	4,75x29,75 cm	1.87"x11.71"	36	42	0,630	6,73	22,50	290,24	505	13,400	11,28
	rodapié	7,3x59,55 cm	2.83"x23.45"	24	18	0,810	8,72	19,44	242,19	452	17,890	6,57
	rodapié	7,3x44,63 cm	2.83"x17.57"	48	14	0,472	5,10	22,66	209,25	506	10,068	6,05
	rodapié	7,3x44,63 cm	2.83"x17.57"	48	13	0,435	4,70	20,88	243,90	484	9,595	8,87
	rodapié	7,3x29,75 cm	2.83"x11.71"	36	29	0,653	6,97	23,51	224,74	669	17,947	8,86
	peldaño simp 30x120	29,75x119,3 cm	11.71"x46.97"		2						18,685	
	peldaño grad 30x120	29,75x119,3 cm	11.71"x46.97"		1						9,485	
	peldaño simp 90x90 / grad 90x90	89,46x89,46 cm	46.97"x46.97"	35	1	0,800	8,61	28,00	301,40	776	21,800	-
	peldaño simp 45x90	44,63x89,46 cm	17.57"x35.22"	27	3	1,198	12,89	32,53	253,01	840	30,259	-
	peldaño grad 45x90	44,63x89,46 cm	17.57"x35.22"	27	2	0,799	8,59	21,57	350,15	570	20,256	-
	peldaño grad 33x90	32,45x89,46 cm	12.77"x35.22"		2	0,581	6,25	-	233,43	-	16,810	-
	peldaño / peldaño ang	59,55x59,55 cm	23.45"x23.45"	30	3	1,063	11,44	31,89	343,27	756,99	25,233	-
	peldaño grad / grad ang	59,55x59,55 cm	23.45"x23.45"	30	2	0,354	3,81	10,62	343,27	281	8,591	-
	peldaño / peldaño ang	29,75x59,55 cm	11.71"x23.45"	16	7	1,240	13,35	19,84	114,64	478	28,449	-
	peldaño grad / grad ang	29,75x59,55 cm	11.71"x23.45"	16	2	0,360	3,88	5,76	213,56	133,1	8,319	-
	peldaño	44,63x44,63 cm	17.57"x17.57"	-	5	0,996	10,75	-	62,00	-	22,750	-
	peldaño ang	44,63x44,63 cm	17.57"x17.57"	-	5	0,996	10,75	-	-	-	22,750	-
	peldaño grad	44,63x44,63 cm	17.57"x17.57"	-	2	0,360	3,89	-	-	-	9,259	-
	peldaño grad ang	44,63x44,63 cm	17.57"x17.57"	-	2	0,360	3,89	-	-	-	9,259	-
	byte lista 90	2x89,46 cm	0.79"x35.22"	-	18	0,322	3,45	-	-	324	10,030	12,56
	fusion graffiato lista 90	1,5x89,46 cm	0.59"x35.22"	-	80	1,074	11,56	-	-	1146	56,130	71,57
	pod / byte lista 60	1,5x59,55 cm	0.59"x23.45"	132	36	0,322	3,49	42,50	457,51	1079	8,000	21,57
	fusion natural lista 60	1x59,55 cm	0.39"x23.45"	132	250	1,500	16,27	198,00	457,51	1949	14,593	100,50
	fusion graffiato lista 60	1,5x59,55 cm	0.59"x23.45"	96	200	1,790	19,24	171,55	2131,46	1376	14,093	119,10
	corner 60	1,5x59,55 cm	0.59"x23.45"	-	14	0,125	1,34	-	1846,57	-	3,160	-
	corner 30	1,5x29,75 cm	0.59"x11.71"	-	30	0,134	1,44	-	-	-	3,440	-



Industrial zone. Zona industriale. Zona industrial:

1.000.000 m<sup>2</sup>

Production plant. Stabilimenti di produzione. Planta de producción:

250.000 m<sup>2</sup>

Production capacity. Capacità produttiva. Capacidad de producción:

5.500.000 m<sup>2</sup>/year

## SYMBOLS



Porcelain  
Porcelánico  
Porcelanatto



White Body  
Pasta Blanca  
Pasta Blanca



Double firing  
Bicocción  
Bicottura



Natural  
Naturale  
Naturale



Lappato  
Lappato  
Lappato



Structured  
Estrutturado  
Strutturato



Polished  
Pulido  
Levigato



Satin  
Satinado  
Satinato



Shiny  
Brillo  
Lucido



Matt  
Mate  
Satinato



Destonified  
Destonificado  
Stonalizzato



Non slip  
Antideslizante  
Antiscivolo



Glass  
Cristal  
Cristallo



Metal  
Metal  
Metallo

[www.landporcelanico.com](http://www.landporcelanico.com)

Ctra. Castellón-San Juan de Moró km. 12,5 12130 San Juan de Moró. Castellón. Spain.  
T: +34 964 70 10 15 | E: [land@landporcelanico.com](mailto:land@landporcelanico.com)



PLEASE RECYCLE WHEN OBSOLETE  
PER FAVORE RICICLARLO QUANDO VECCHIO  
POR FAVOR RECICLAR CUANDO QUEDE OBSOLETO  
WENN NICHT MEHR AKTUELL, RECYCELN  
S'IL VOUS PLAÎT, MERCI DE RECYCLER



Land Porcelanico App

