

GENERAL CATALOGUE / 2020



zonauno
MADE IN ITALY

Il nostro segreto

ZonaUno ti permette di risolvere in modo efficiente numerose situazioni che si presentano in fase di costruzione e ristrutturazione del tuo ambiente.. ZonaUno trova largo utilizzo in ogni ambiente sia residenziale, pubblico o commerciale. ZonaUno ti propone di trasformare il tuo spazio, rendendolo attuale estremamente accattivante ma soprattutto suggestivo. Ti assicuro che scegliendo zonauno aumenteremo il valore percepito di casa tua, del tuo ufficio, o magari del tuo ristorante, negozio o hotel, come mai immagineresti. Molti offrono porte a filo del muro, ma nessuno ha esperti interiors design esclusivamente a tua disposizione per pensare al meglio il tuo spazio con professionalità .

Difficilmente troverai una casa uguale all'altra perchè con le nostre porte sappiamo rendere unico il tuo spazio. Non ci credi? Mettici alla prova e vedrai che non sono solo parole...

ZoneUno allows you to efficiently solve many situations that are under construction and renovation of your environment. ZonaUno is widely used in any environment residential, public or commercial. ZoneUno proposes you to transform your space, making it extremely current attractive but above all impressive. I assure you that choosing the area will increase the perceived value of your home, yours Office, or maybe your restaurant, shop or hotel, how would you ever imagine. Many offer wall-mounted doorways, but no one has expert interior design at your disposal to better think about your space professionally. You will find a house of the same size as the one with the doors we know to make your space unique. Do not you believe it? Have a try and you will see that they are not just words ...

zonauno
MADE IN ITALY







ZONA 1 80X210 A SPINGERE E TIRARE c/maniglia zona1
Door Zona 1 80x210 push/pull with a handle Zona 1

Una scelta ragionata

Caratteristiche tecniche e plus di prodotto

A deliberate choice

Technical characteristics
and product advantages

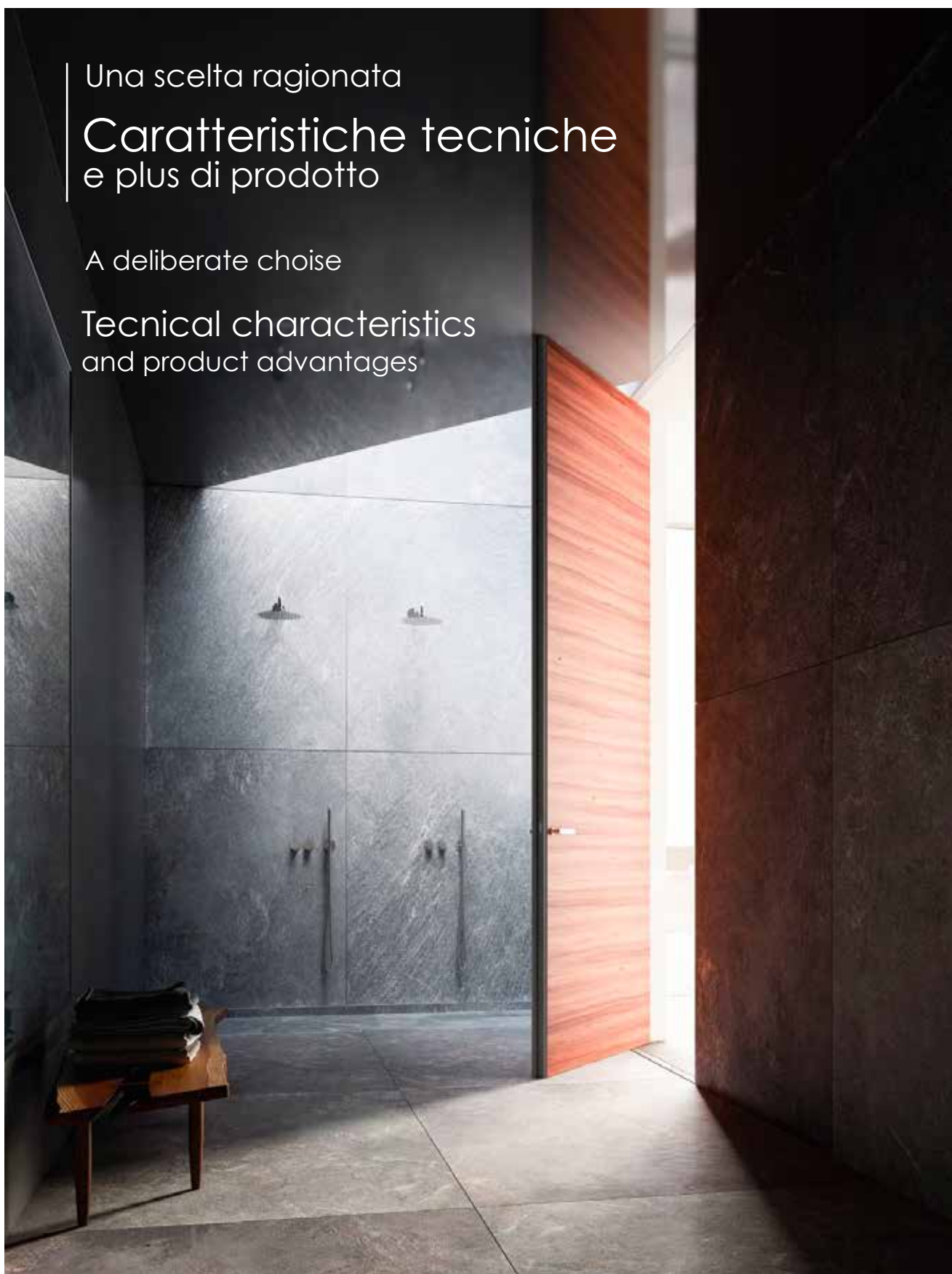

- 7 **anta reversibile spingere/tirare con medesimo telaio**
reversible leaf push/pull with the same frame
- 7 **anta con cementite ballata in scatola di cartone**
door with a lay of cementite packed in a cardboard box
- 7 **serrature e cerniere montate**
assembled latch and hinges
- 7 **5 mt di guarnizione nell'imballo**
5 mt of gasket in packaging
- 7 **telaio con tappi su alloggiamento cerniere per evitare imbrattamenti di intonaco in fase di posa**
frames with caps on the hinges to prevent soiling of the plaster during the set-up.
- 7 **telaio assemblato con dima di truciolare montata per perfetta, facile e veloce posa dello stesso**
frame, assembled with a ready to use chipboard template for a perfect, easy and fast installation
- 7 **set con retina e zanche per muratura**
set with a net and anchors for masonry
- 7 **telai e ante separate: consegna in momenti diversi senza problemi**
separate frames and doors: delivery at different times without problems
- 7 **cerniere regolabili su tre assi**
hinges adjustable on three axes
- 7 **cerniere e serratura cromo satinato già montata sull'anta**
satin chrome hinges and the latch already mounted on the leaf
- 7 **serratura magnetica**
magnetic latch
- 7 **mano cementite anche su battute**
layer of cementite on the door edges
- 7 **dima già installata sul telaio per posa facile e precisa**
ready to use template on the frame for an easy and precise set-up.
- 7 **10 anni di garanzia sulle parti metalliche: cerniere, serratura, telaio.**
a 10-year warranty for the metal parts: the hinges, the latch, the frame.
- 7 **Possibile estensione di garanzia a 20 anni**
possible extension of the warranty up to 20 years.
- 7 **Pronta consegna nelle misure standard: 70/80x210**
standard sizes 70/80 x 210 ready for delivery
- 7 **Ante laccate in tutti i RAL, NCS, a campione**
Lacquered doors in all RAL, NCS, up to choice.





Posa in opera

ZonaUno mette a disposizione un servizio di posa in opera qualificata che si occupa in toto dell'installazione dei prodotti, lasciando all' acquirente solo il piacere e la libertà di godere l'emozione di una porta unica e inimitabile.

Offriamo una capillare e organizzata rete di squadre di posatori specializzati, presente su tutto il territorio nazionale, che operano con competenza e professionalità per garantire le migliori prestazioni estetiche, funzionali e di durabilità dei prodotti

ZonaUno garantisce la tua tranquillità. Per le tue richieste di installazione rivolgiti

ZonaUno offers you highly qualified, start-to-finish installation services. We'll leave you only the pleasure and freedom of enjoying a unique and incomparable door.

Our widespread and well – organized network of specialized teams of installers is available countrywide; their experience and professionalism are at your service to guarantee that our products are aesthetically pleasing, functional and highly durable.

Versione Cartongesso 1 lastra

Version 1 plasterboard sheet

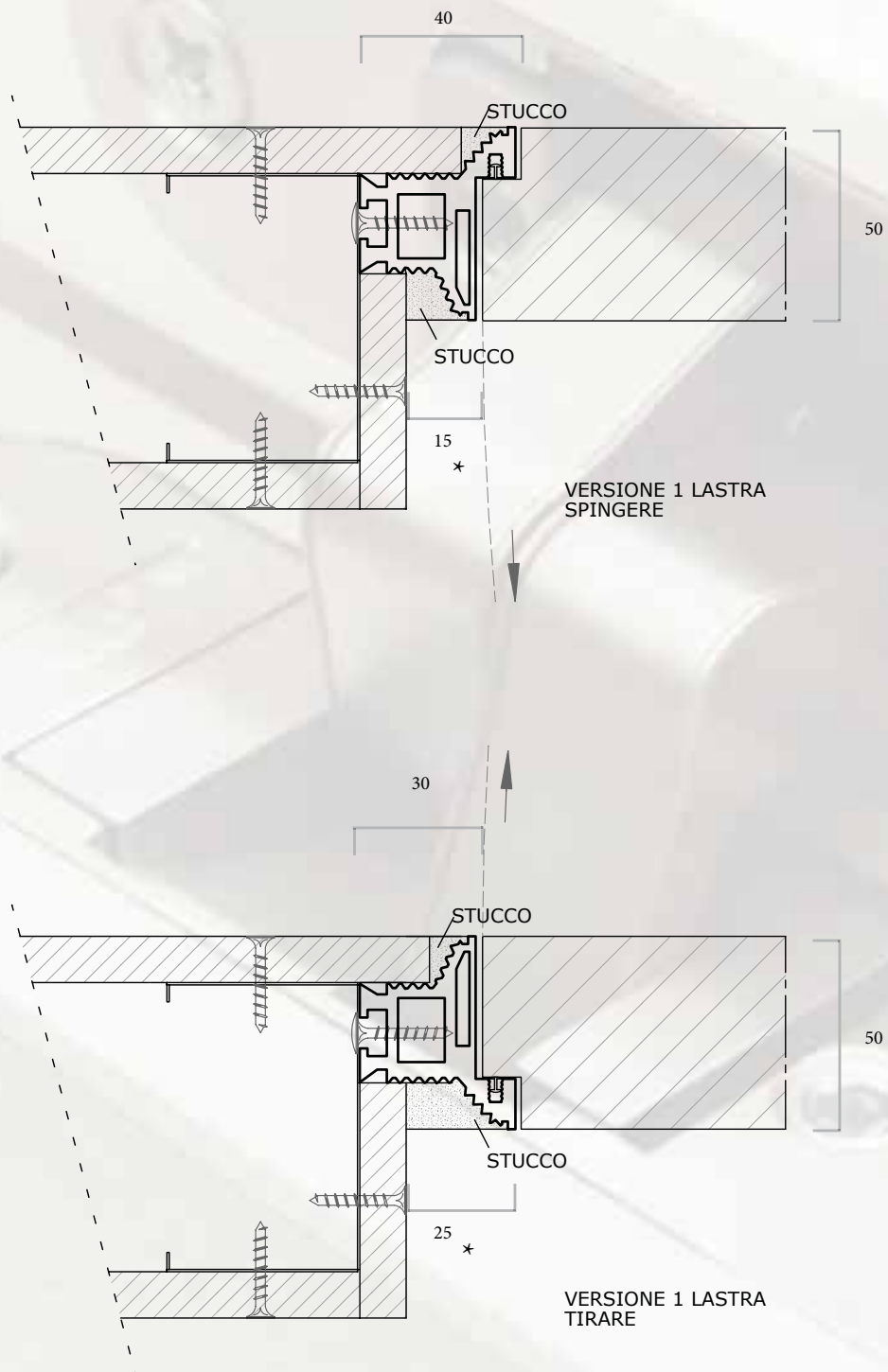

* misure consigliate
Recommended measures

Versione Cartongesso 2 lastre

Version 1 plasterboard sheet

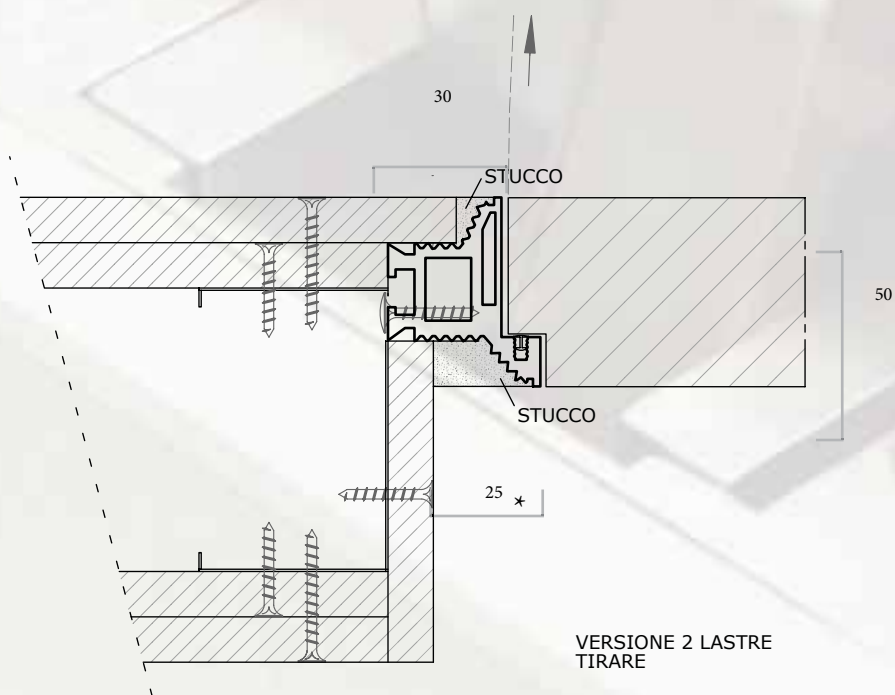
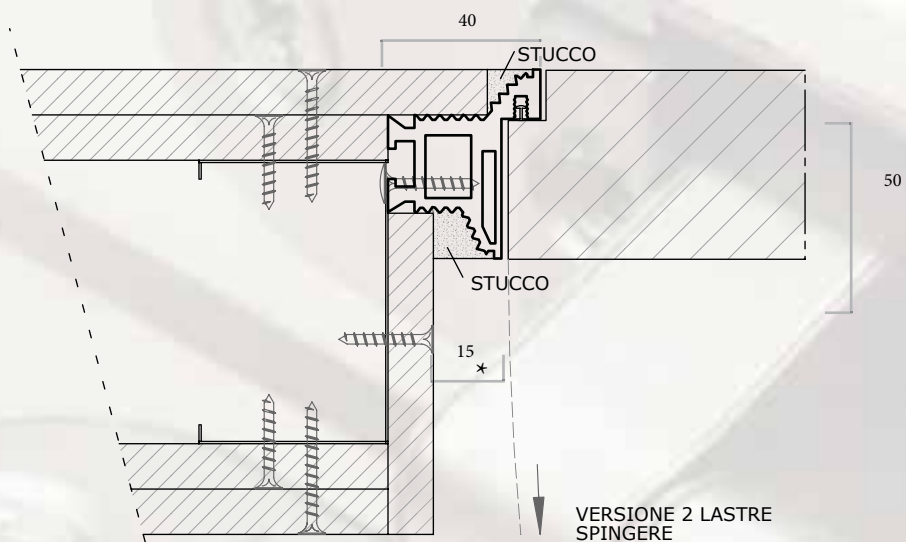

* misure consigliate
Recommended measures

Versione Muratura

Version masonry

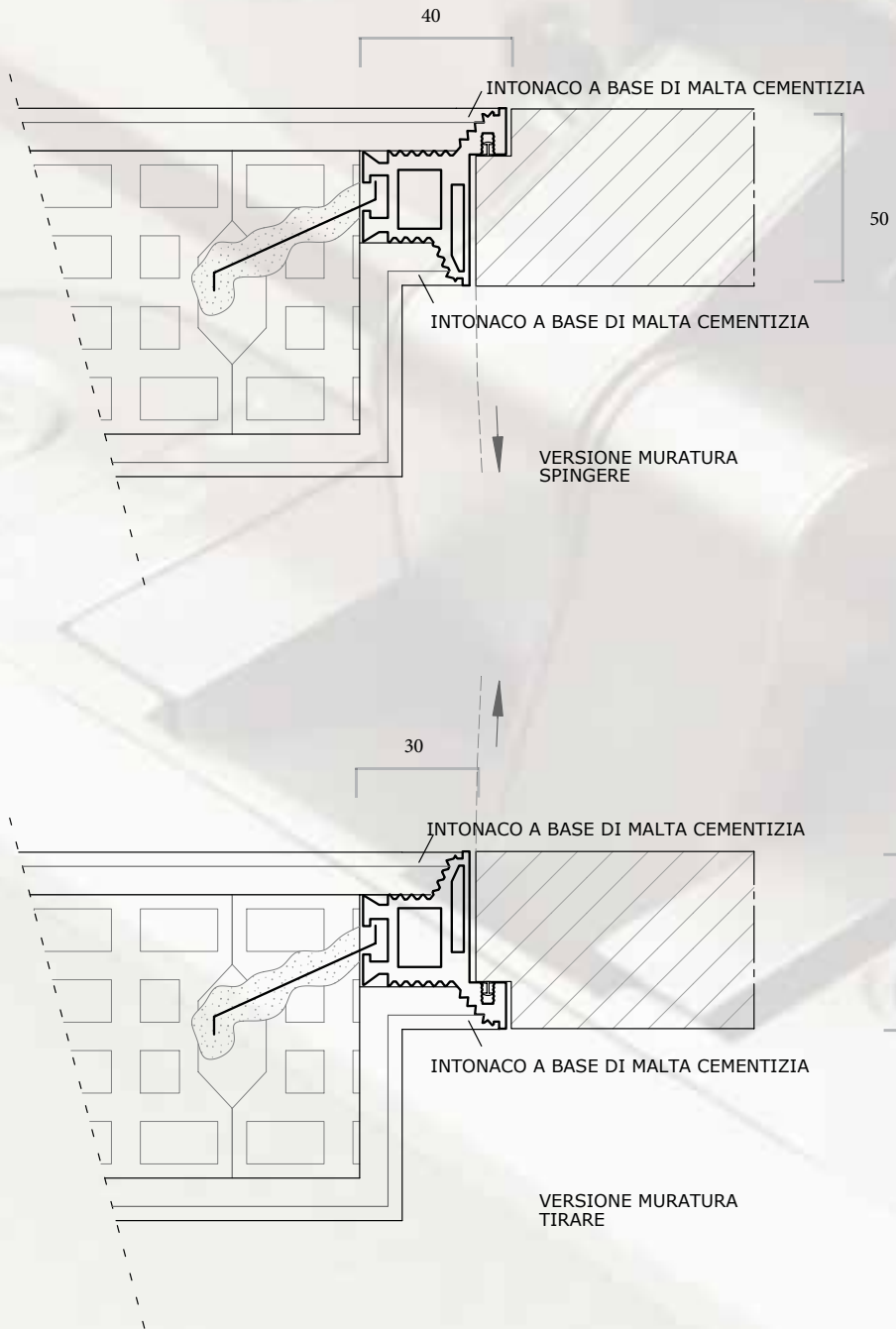

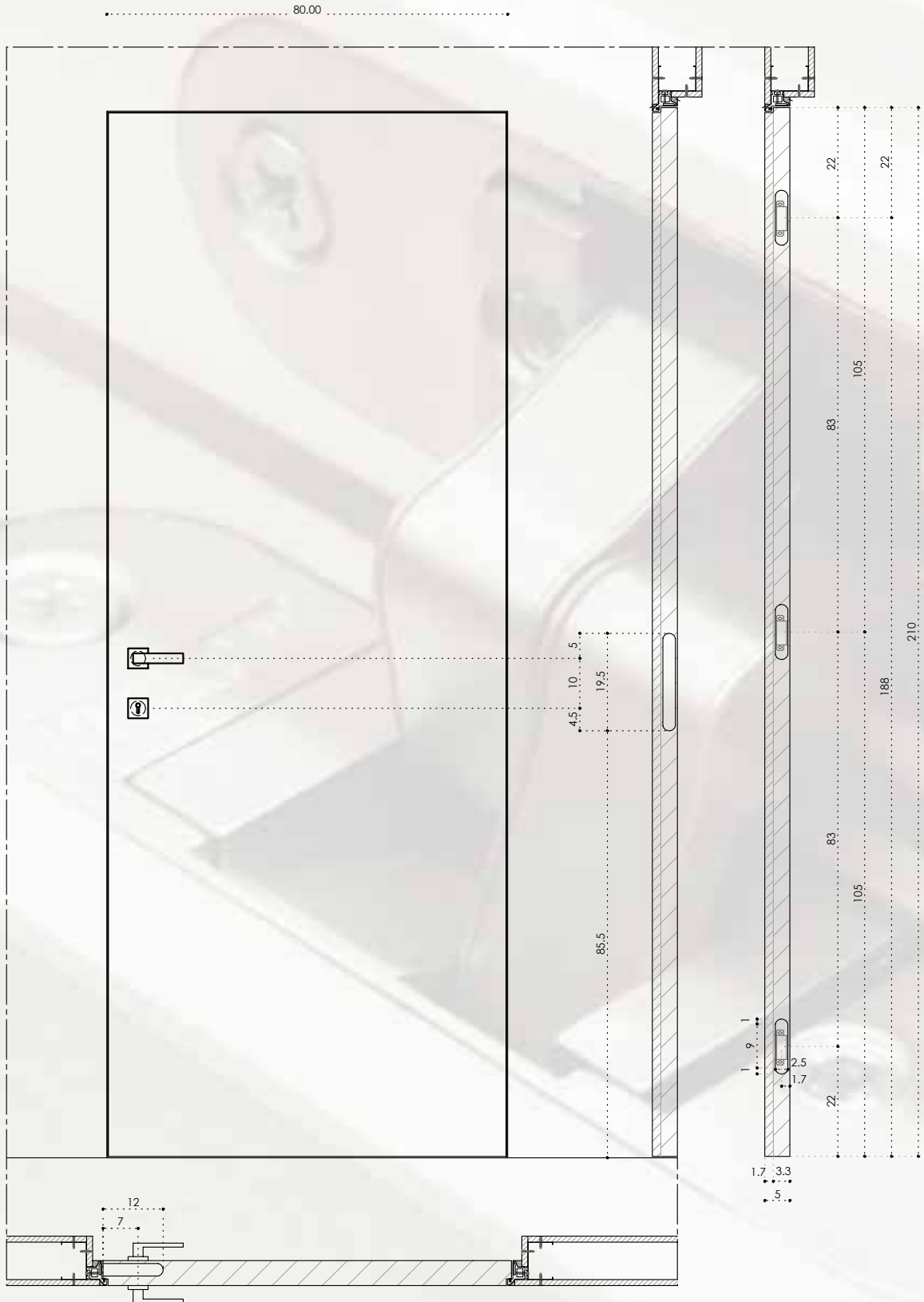

Offriamo supporto e collaborazione nella progettazione di una porta personalizzata: vogliamo aiutarti a realizzare esattamente quello che hai in mente.

Grazie ad una ultra decennale esperienza ed ad un patrimonio di conoscenze, anche internazionale, il nostro reparto produttivo è capace di realizzare pezzi unici affidabili nel tempo.

Proteggiamo quello che abbiamo realizzato fino alla sua destinazione definitiva, tanto ne siamo orgogliosi. Ovunque essa sia.

Installiamo i nostri prodotti significa esserne responsabili per tutto il ciclo. Siamo contenti di poter offrire anche questo servizio per mantenere il nostro standard elevatissimo.

We offer support and collaboration in designing a customized door: we want to help you realize exactly what you have in mind.

Thanks to an ultra-ten-year experience and a wealth of knowledge, even international, our production department is capable of delivering unique reliable pieces over time.

We protect what we have accomplished to its ultimate destination, so we are proud of it. Wherever it is.

We install our products means to be responsible for the whole cycle. We are delighted to be able to offer this service to keep our standards high.





**Abir la mente
a la imaginacion
es como entrar en un
meravilloso jardin**

Opening the mind to the
imagination is like entering
a garden full of marvels.

THROUGH THE

**Offen zu sien fur Fantasie
ist wie einen wundervollen
Garten zu betreten**

SECRET

PASSAGES

*Ouvir l'esprit a' l'immagination
c'est comme entrer dan un jardin
merveilleux*

*Aprire la mente
all'immaginazione
è come entrare in un
meraviglioso giardino*

















Dans Projekt wird zur
Bedeutung
wenn es das findet
das ihm Form verleiht

WORKING ON A PROJECT

*Le projet prend toute sa
signification
quand on trouve ce que peut lui
donner forme*

*A project acquires
meaning when it finds the way
to reach its form*

*El proyecto pasa a ser significado
cuando encuentra aquello que
puede darle forma*

il progetto diventa
significato quando trova
ciò che può dargli forma



***“ La maniglia
accentua la pulizia
delle forme per un
effetto minimalista
senza eguali ”***

***“The handle
Accentuates cleanliness
Minimalist effect
Without equal “***





***“ Maniglia MilanoExpo: Solidità, bellezza e design
caratterizzano questa moderna maniglia in 2 versioni -
cromo satinata e cromo lucida “***

***“Handle MilanoExpo: Solidity, beauty and design
characterize this modern handle in 2 versions -
Satin chrome and glossy chrome “***



Finiture e prezzi

Standard in L: 60/65/70/75/80/85/90

Finishes and prices

Standard in L: 60/65/70/75/80/85/90

Ante pantografate Cat. 1 pantographed doors Cat. 1

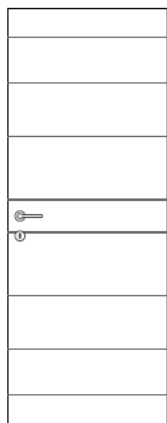

Buccinasco

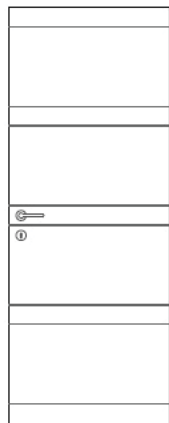

Cairolì

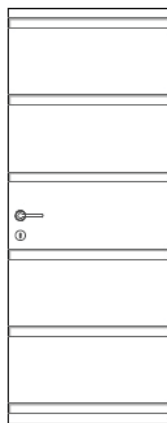

Missori

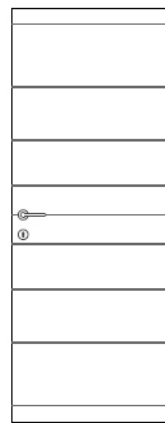

Sforzesco

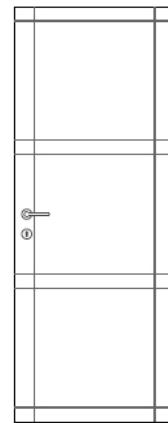

Nosedo

Ante pantografate Cat. 2 pantographed doors Cat. 2

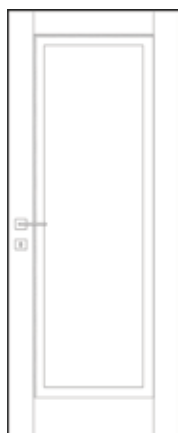

Assago

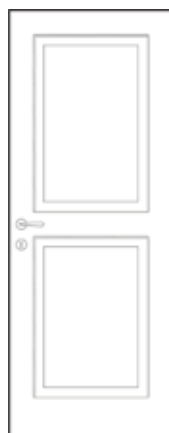

Diaz

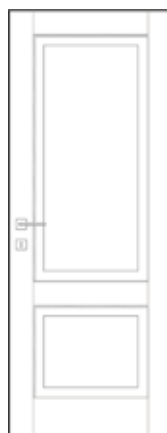

Lambrate

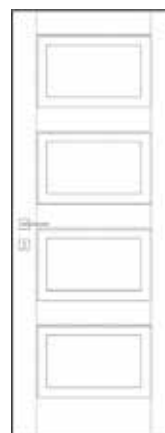

Palestro

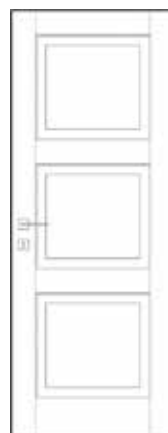

attuada





TUS
ENIGMAS
LOS MIBS
CIPRIANO
ET ANNA
MILY DI

zona1**uno**
MADE IN ITALY

S.S.Cremasca 22B
24052 Azzano San Paolo - Italy
T. +39 035 531798 F. +39 035 531712
www.zonauno.net