

EPÒNIMO

2020 COLLECTION



Sexy Beast	2
Big Bubble	4
Big Game	8
Nova two-seater	10
Gotham two-seater	12
Medven two-seater	14
Nova lounge chair	16
Gotham armchair	18
Exo	22
Heritage	24
Nova armchair	26
OW armchair	28
Medven armchair	30
“O”	32
New Outline	34
Nova chair	36
Nua	40
Bic	42
Aluchair	44
Rock table	48
Wood table	50

Nadi table	52
Roll table	54
Big Sur desk	56
Rock low table	58
Ghost low table	60
Wood low table	62
Roll low table	64
Big Sur low table	66
MT low table	68
Nadi low table	70
Rock side table	72
Wood side table	74
Roll side table	76
MT side table	78
Long Playing side table	80
Gotham side table	82
New Outline bench	84
Gotham bench	86
Long Playing étagère	88
Gotham wardrobe	92

2020 Collection

Our collection mediates between memories of the past and opportunities of the present, integrating familiarity with aesthetic and technical innovation, the core elements of contemporary furniture. The execution of Eponimo's pieces is always technically modern but their aesthetic inspirations span through time: most are original concepts developed with a strong modern identity, while some evolve from promising archetypes and models from the past. We work with high-quality natural materials: marble, solid wood, leather, fabrics - and our products are largely hand-made and always hand-finished. Ultimately they are functional, comfortable, elegant and unique.



Sexy Beast

Rich, plush, round volumes and luscious comfort in a small-sized sofa. The ends of the armrests and backrest are angled at 45 degrees: this visual trick greatly increases the perceived width of the elements and the perceived size of the sofa. In addition, while Sexy Beast is not a sectional piece, the angle helps to position two matching sofas in a typical L-shaped composition. We use an absolute minimum amount of polyurethane and only in a very few critical points. Comfort is obtained through elastic straps, dacron and natural down. The cover is fully removable.

Solid poplar or pine and poplar or pine plywood internal frame. Elastic support straps, polyurethane core, dacron lining, with covers in cotton velvet, aniline leather or customer fabric, down-filled seat cushions.





Big Bubble

An essential and yet sumptuous sofa that integrates an unprecedented level of comfort and a clean image through the careful study of proportions, filling materials and surface treatment. It is a mint product that combines the flair of something lived-in with the appeal of modern performance. The soft surfaces and extra flesh of a sofa that has lost its shameless turgidity are the sign of a lasting and mature elegance.

Solid poplar, poplar plywood and birch plywood internal frame. Elastic support straps, polyurethane core, dacron lining coupled with cover material, with covers in cotton velvet, aniline leather or customer fabric, down-filled seat cushions.



From terminal pieces to angular modules to poufs, Big Bubble offers a full vocabulary of sectional elements to create a multitude of compositions and to adapt to every space and environment. The additional possibility to customize any of the elements makes Bug Bubble a truly and universally adaptable system.



Big Game

Big Game is inspired by a specific old sofa, classically sober in its lines, open in its volumes and comfortable in a contemporary sense because of the break-down of the internal filling and spring structure. We kept the original proportions of the prototype while changing the height, the seating angle, the inside filling, the skin and the stitching, both technically and aesthetically. This deconstruction process further increases the sofa's softness and overall aged character while paradoxically neutralizing the antiquity of the prototype.

Solid poplar frame, helical metal coil springs, polyurethane core, dacron lining coupled with the cover material, with covers in cotton velvet, aniline leather or customer fabric, down-filled seat cushions.

Nova two-seater

Nova is family of light-weight textile chairs and armchairs with a precious look and a fully removable fabric cover. A fully textile look combined with physical and visual lightness and the possibility to remove the cover - through four zippers located under the seat - are the characteristics of an absolutely unique and original product. The Nova sofa is a perfect two-seater for smaller spaces: when combined with the armchair and pouf of the same line it creates a full and yet contained living room set.

Metal tube structure, elastic support belts, internal cushions in polyurethane, dacron lining, with covers in cotton velvet, Kvadrat Steelcut 2, Aura Guess, aniline leather or customer fabric.



Gotham two-seater

The distinctive linear geometry and the visual lightness of the Gotham sofa come from its metal frame, a clean aerial structure that holds the seat and backrest cushions. These in contrast are generous and voluminous thus creating a visual juxtaposition between the supporting base and the upholstered elements, between structural need and seating comfort. The Gotham sofa is a perfect two-seater for smaller spaces. Combined with the armchair and pouf of the same line it creates a full and yet contained living room set.

Grey cadet painted steel structure, solid oak armrests, polyurethane cushions with covers in casentino wool, cotton velvet, cotton corduroy, anilina leather or customer fabric. The steel structure can be painted in other colors upon request.





Medven two-seater

Medven 2-seater is made of multiple steel frames that are individually upholstered and then assembled. The deliberately abundant cover and the soft internal filling give the armchair an informal and inviting character. Medven features four casters for increased mobility and versatility of use.

Steel structure, elastic support straps, polyurethane cushions, dacron lining, with covers in aniline leather or customer fabric.





Nova lounge chair

Nova is a light-weight textile lounge chair with a precious look and a fully removable fabric cover. The internal structure is a minimal metal tube skeleton that supports the elastic straps and the polyurethane cushions and that determines the form of the upholstered chair. A fully textile look combined with physical and visual lightness and the possibility to remove the cover, through four zippers located under the seat, are the characteristics of an absolutely unique and original product. Nova is available with or without armrests.

Metal tube structure, elastic support belts, internal cushions in polyurethane, dacron lining, with covers in cotton velvet, Kvadrat Steelcut 2, aniline leather or customer fabric.





Gotham armchair

The distinctive linear geometry and the visual lightness of the Gotham sofa come from its metal frame, a clean aerial structure that holds the seat and backrest cushions. These in contrast are generous and voluminous thus creating a visual juxtaposition between the supporting base and the upholstered elements, between structural need and seating comfort. We often upholster the cushions with panno Casentino, the traditional Tuscan wool historically used in the garment industry and introduced by Eponimo into the world of contemporary furniture. A great alternative is our cotton corduroy as the three-dimensional texture of the fabric matches the linear geometry of the armchair's metal structure. The perfect partner for our Gotham armchair is the homonymous ottoman.

Grey cadet painted steel structure, solid oak armrests, polyurethane cushions with covers in casentino wool, cotton velvet, cotton corduroy, anilina leather or customer fabric. Upon request the steel structure can be painted in any other color of the RAL system.



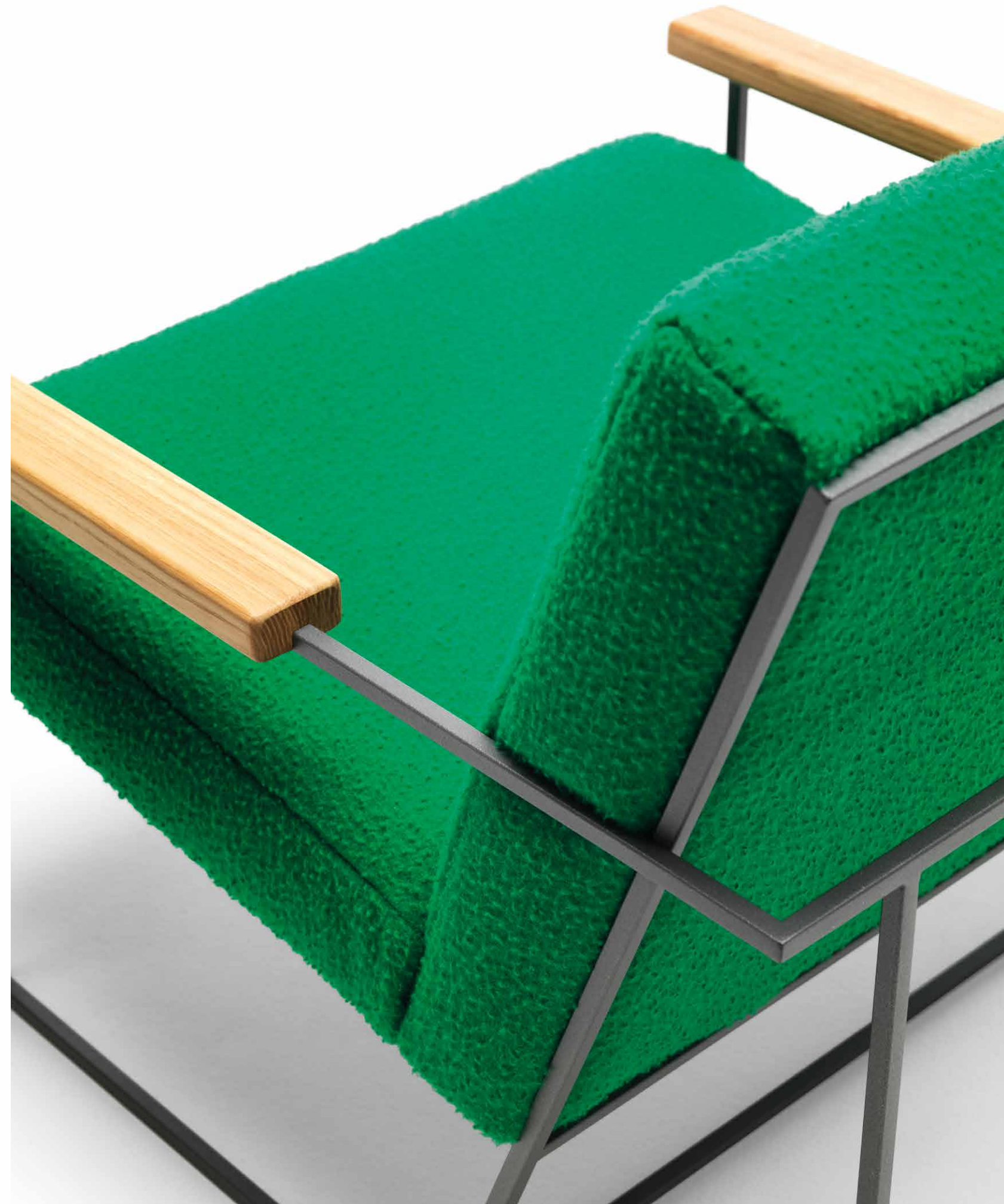



Exo

The cow-hide in the Exo armchair is both surface and structure. Like in an insect's exoskeleton there is no internal support structure. In both products the polyurethane body is covered with cow-hide panels that once sewn together become structural. The material of the shells and their surfaces are rich but the objects are extremely light. The slight tilt of the armchair's base and the flexibility of the armrests allow for a seating style that follows the movements of the body. Available in 30 colours.

Cow-hide shell, polyurethane core.



Heritage

It is a contemporary interpretation of a rare Chiavari dormeuse from the XIX century, surprisingly light and original in its forms. To update its design we simplified the lines, we eliminated the decorative lathe work, we used intertwined textile straps for the seat and we chose a black matte finish. The dormeuse is still completely hand-made.

Solid maple wood painted matte black with teal coloured fabric straps seat. Other finishes and colours available upon request.





Nova small armchair

The Nova small armchair is the latest addition to the homonymous family of products. It is a light-weight textile armchair with a precious look and a fully removable fabric cover. The internal structure is a minimal metal rod skeleton that supports the elastic straps and the polyurethane cushions and that determines the form of the upholstered chair. A fully textile look combined with physical and visual lightness and the possibility to remove the cover - through four zippers located under the seat - are the characteristics of an absolutely unique and original product.

Metal tube structure, elastic support belts, internal cushions in polyurethane, dacron lining, fabric or leather cover.



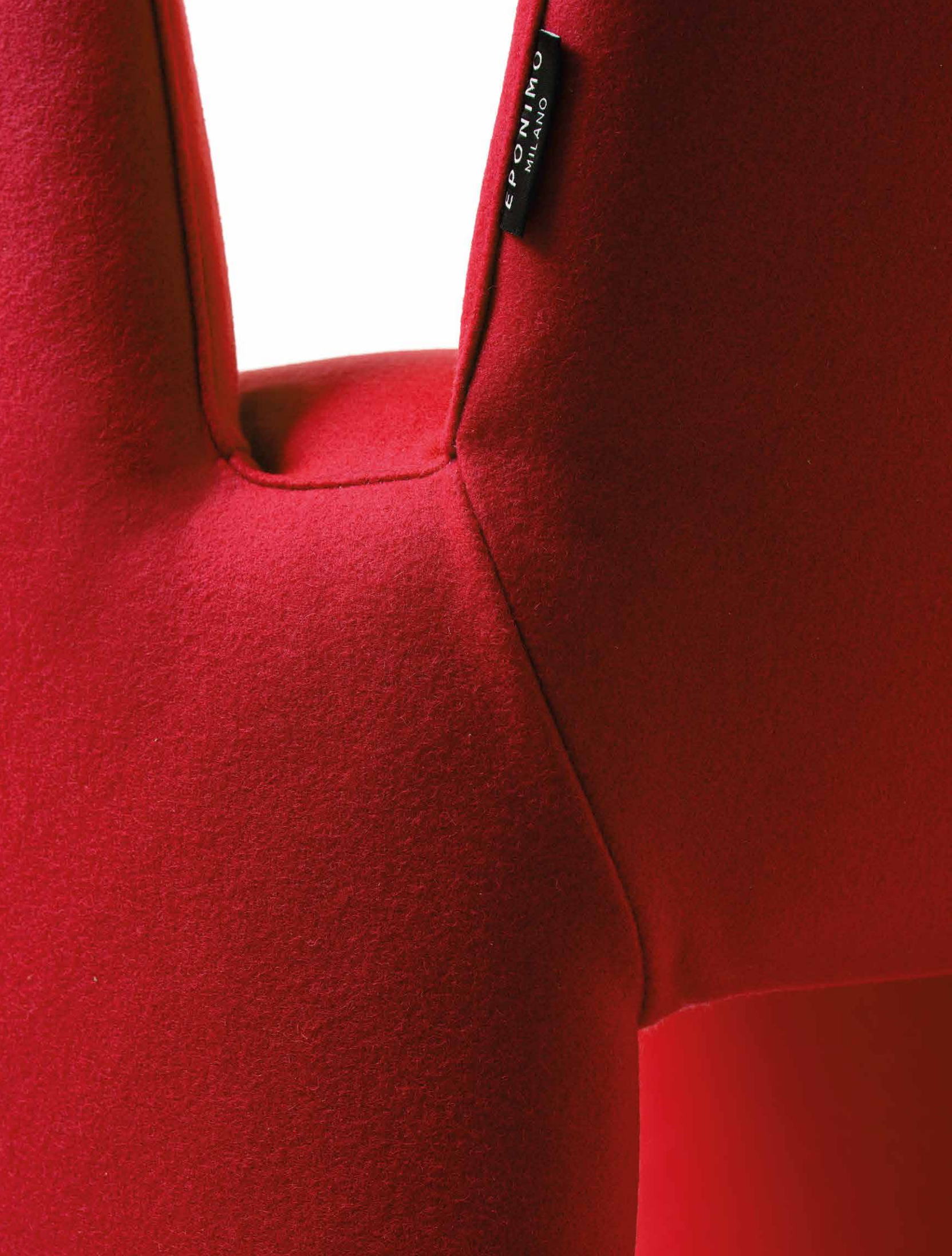

OW

OW features a fully removable cover and 4 mono-directional wheels - to easily slide under a table and away from it - making it the perfect dining and conference room armchair.

Metal tube structure, elastic support belts, internal cushions in polyurethane, dacron lining, with covers in Arredamento Lombardo cotton velvet, Kvadrat Stellcut 2 and Divina, Aura Guess, anilina leather or C.O.M.



Medven small armchair

Medven is a textile armchair made of multiple steel frames that are individually upholstered and then assembled. The deliberately abundant cover and the soft internal filling give the armchair an informal and inviting character. Medven features four casters for increased mobility and versatility of use.

Steel structure, elastic support straps, polyurethane cushions, dacron lining, with covers in aniline leather, cotton corduroy or customer fabric.

“O”

“O” is made of multiple cow-hide panels sewn over steel frames. It’s an intelligent manufacturing technique re-invented here through an original and contemporary design. When seen from above the seat is a square inscribed in the circle defined by the backrest and armrests. Thanks to the plastic nature of cow-hide, this rigorous geometry when developed in space becomes a fluid and functional harmonic language. “O” is available in 30 colours.

Steel structure, cow-hide cover, fabric-covered polyurethane pillow.





New Outline small armchair

Outline was developed by maximizing the integration of form and function while using minimum material. The steel rod frames define a contour that is slender and light, becoming armrests and backrest as a simple and fluid line. The fully removable seat pan and backrest are made of rich cow-hide. Hidden elastic belts allow them to flex with the weight of the body without stretching thus preventing them from losing their shape and structural property. Familiarity and innovation.

Cadet gray or black painted steel structure. Cow hide seat and backrest (20 colors available) with internal elastic support straps.

Nova chair

Nova is a light-weight textile chair with a precious look and a fully removable fabric cover. The internal structure is a minimal metal skeleton that supports the elastic straps and the polyurethane cushions and that determines the form of the upholstered chair. A fully textile look combined with physical and visual lightness and the possibility to remove the cover - through four zippers located under the seat - are the characteristics of an absolutely unique and original product. Nova is available with or without armrests.

Metal tube structure, elastic support belts, internal cushions in polyurethane, dacron lining, with covers in cotton velvet, Kvadrat Steelcut 2, Aura Guess, aniline leather or customer fabric.





The Nova chair with armrests: for the head of the dining table or by itself for additional comfort. Still extremely light and slender. Remarkably even in this version Nova's cover is fully removable.





Nua

Nua is extremely light, comfortable, visually striking and stackable. The metal structure was developed using the principle of the trestle where each welded steel-rod segment contributes to the overall rigidity and equilibrium of the assembly. Comfort is provided by two cushions held in place by the geometry of the structure without the need for any type of fastening element. Nua champions a philosophy of economy of material where the visual expression of a physical principle translates directly into the form of the final product.

Structure made of painted steel rods in black, red or white. Polyurethane-filled cushions with covers in Kvadrat Steelcut 2 or customer fabric.

Bic

Bic chair is made by a single metal assembly that supports the upholstered seat and holds the legs and the backrest. The use of different materials in the parts of the chair allows us to take full advantage of their structural properties and their surface qualities: the tactile richness of solid wood for the backrest, the softness of ecoleather and foam for the seat, the rigidity of metal in the supporting structure and the durability of the unpainted natural finish in the solid-wood legs.

Painted steel structure, solid wood legs and backrest, ecoleather upholstered seat with elastic support belts and polyurethane cushion. Available in black or white with legs in natural wood.



Aluchair

Aluchair features the form of the archetypal wooden chair but it is made of solid metal: the body is created by mechanically joining two cleverly folded sheets of aluminium. No welding is involved in the manufacturing process. We offer Aluchair with a shiny, polished, mirror-like surface or with a semi-gloss powder coated finish. Four small aluminium cylinders complete the legs and house the rubber feet, making Aluchair extremely quiet despite its full aluminium body. Aluchair is simple and light and yet precious and comfortable.

Alluminium body, rubber feet. Available in RAL grey blue 5008, traffic red 3020, pale green 6021 or polished alluminium finish.



Aluchair is available with a semi-gloss powder coated colored finish, in red, green and blue. Other colors are available upon request.





Rock table

A 4-legged table completely made of stone. Through a simple trick the table, which is in fact the assembly of five parts, appears sculpted from a solid block. The four lateral elements, once they are assembled with the top, become structural without the need for additional parts that would in turn compromise the sculptural effect of the piece. The surface of the table is treated with a slightly three-dimensional weathered finish that further increases the preciousness and uniqueness of the natural material and that in time hides potential scratches and stains.

White Carrara, black New Saint Laurent or Cipollino marble. Weathered finish. Other stones and finishes are available upon request.

Wood table

A 4-legged table made of MDF finished with blue stained eucalyptus veneer. Through a simple trick the table, which is in fact the assembly of five parts, appears sculpted from a solid block. The four lateral elements, once they are assembled with the top, become structural without the need for additional parts that would in turn compromise the sculptural effect of the piece. The proportions of our Wood table, inspired by the traditional *fratine*, enhance the perception of its length and the intimacy among diners.

MDF, blue eucalyptus veneer. Other veneers are available upon request.



Nadi table

The project re-interprets the structure of an antique table, large but extremely light, through an aesthetic gesture that enhances the age and at the same time the modernity of the piece. The glass top reveals the skeleton of the support, typically hidden by a solid top. The contrast between inside and outside, between light and dark, becomes the aesthetic theme, expressed through the use of two different woods (mahogany and larch) and two different finishes. The glass top creates a showcase-like effect and becomes a window to the history of the table.

Solid black-stained mahogany external structure, natural solid larch internal structure, tempered glass top. Other finishes and colours available upon request.



Roll table

Roll is Epònimo's central stem dining table. The base, carved from a single block of marble, is a geometric and yet organic sculpture that changes dramatically when viewed from different angles. Functionally it supports a thick but clear glass top which maintains a perfect visual balance with the marble volume below without hindering the view of it. With our standard glass top our Roll table seats 8 people.

New Saint Laurent marble, and 15mm extra-clear tempered glass. Other stones are available upon request.





Big Sur desk

An original desk with a wooden top and a glass extension that can rotate around a central pivoting point, like the hand of a clock. This allows the table to expand and contract its usable surface and to adapt to different uses: a dedicated support for a printer or other peripherals, a smaller desk for an additional person or simply more tabletop space. Both tops are supported by a light and essential structure made of copper tubing: the rich warm metal of the base plays beautifully against the natural surface of the wood and the transparency of the glass. The wooden top fits onto the base through four cut-outs - enhanced by a red lacquered finish - that hold it firmly in place. The glass top is also held in place by three circular cut-outs that grab onto the copper structure.

Internal steel structure, external copper tubing, top in oak-lacquered MDF, rotating extension in 15 mm float glass.

Rock low table

A 4-legged coffee table completely made of stone. Through a simple trick the table, which is in fact the assembly of five parts, appears sculpted from a solid block. The four lateral elements, once they are assembled with the top, become structural without the need for additional parts that would in turn compromise the sculptural effect of the piece. The surface of the table is treated with a slightly three-dimensional weathered finish that further increases the preciousness and uniqueness of the natural material and that in time hides potential scratches and stains.

White Carrara, black New Saint Laurent or Cipollino marble. Weathered finish. Other stones and finishes are available upon request.

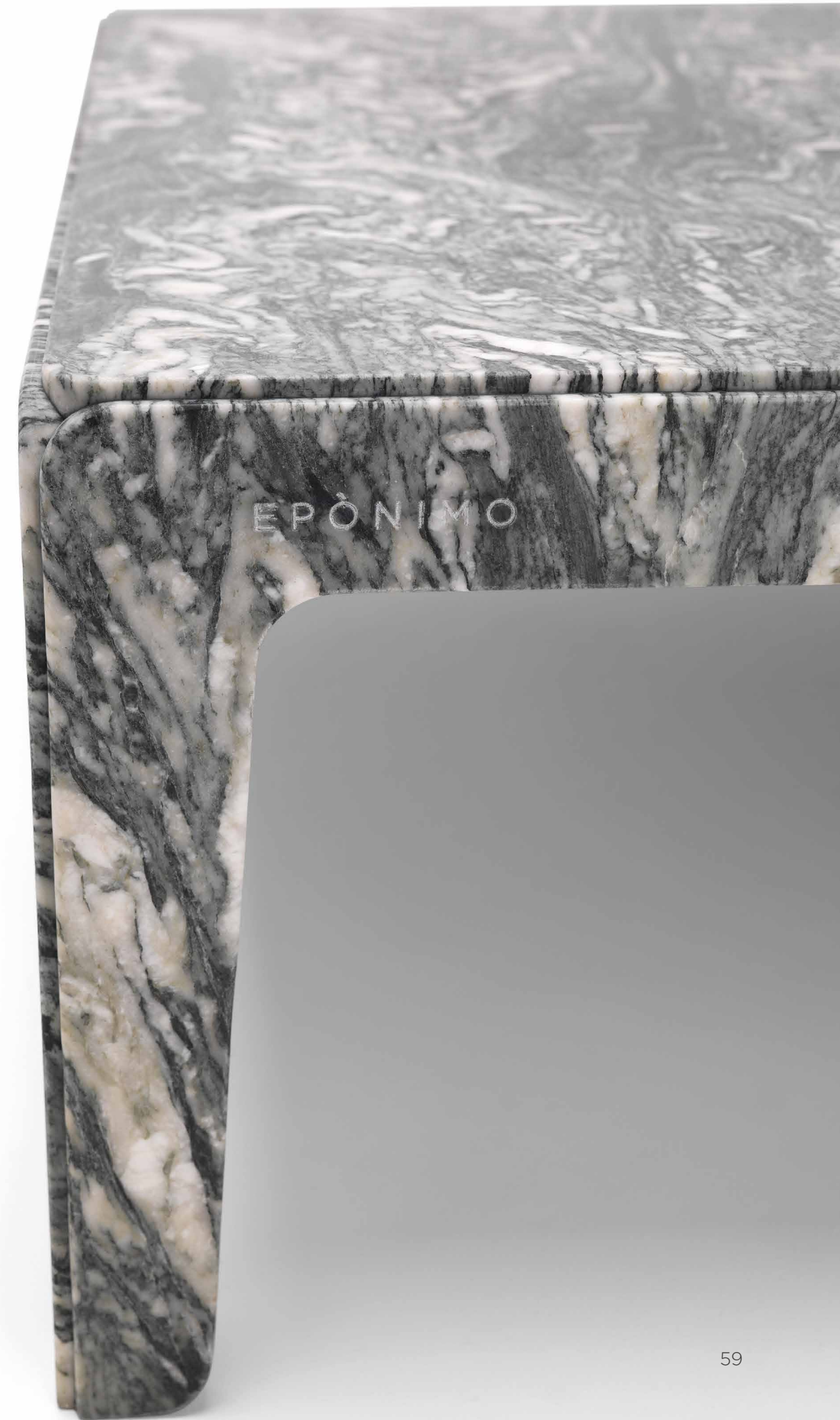



Ghost low table

A 4-legged low table completely made of glass, Ghost is the transparent version of our best-selling Rock low table and it shares the same original sculptural detail. But while the marble version creates the illusion of a table sculpted out of a solid piece of stone, Ghost reveals its construction through the transparency of its material. Surprisingly this clarity only adds to the magic of the piece which becomes extremely ethereal. As one moves around the table its lines and details are revealed and hidden in an ongoing optical play.

Float glass.





Wood low table

A 4-legged low table made of MDF finished with blue stained eucalyptus veneer. Through a simple trick the table, which is in fact the assembly of five parts, appears sculpted from a solid block. The four lateral elements, once they are assembled with the top, become structural without the need for additional parts that would in turn compromise the sculptural effect of the piece.

MDF, blue eucalyptus veneer. Other veneers are available upon request.





Roll low table

Roll low table is a sculptural solid marble piece. Its geometric and yet plastic and organic form changes dramatically when viewed from different angles. Roll is also extremely functional: its cylindrical essential volume will fit a multitude of environments. The internal cavity serves as storage space for pillows, books, magazines, etc. The top surface features a raised lip to safely prevent objects from falling or sliding off.

New Saint Laurent marble. Other stones are available upon request.



Big Sur low table

An elegant low table with two tops that can rotate around a central pivoting point, like the hands of a clock. This allows the table to modify its usable surface and to adapt to different uses and spaces. The opposite curves of the two asymmetrical elliptical tops create a sinuous flow that visually holds them together. They are supported by a light and essential structure made of copper tubing: the rich warm metal of the base plays beautifully against the natural surface of the stone or the saturated but translucent glass tops.

Internal steel structure, external copper tubing, tops in back-painted glass (all RAL colors available), marble (white Carrara, green/gray Cipollino, black New Saint Laurent) or quartzite (green Bamboo).



MT low table

The MT coffee table is at once simple and rich. The base is made with a very thin squared metal tubing which results in physically and visually light and clean geometric structure. The oval top is thick solid marble made visually lighter by a bevelled edge. Available in 2 heights.

Grey cadet painted steel structure with marble top in New Saint Laurent, Carrara or Cipollino marble. Other stones are available upon request.



Nadi ST low table

Nadi re-interprets the structure of an antique table, rich but extremely light, through an aesthetic gesture that enhances the age and at the same time the modernity of the piece. The coffee table version features a sunken top upholstered in blue cotton velvet that contains and protects objects like an oversized box. An original concept created for commercial contexts and now carried into the home.

Solid black-stained mahogany structure with sunken top upholstered in blue cotton velvet. Other colours are available upon request.





Rock side table

A 4-legged side table completely made of stone. Through a simple trick the piece, which is in fact the assembly of five parts, appears sculpted from a solid block. The four lateral elements, once they are assembled with the top, become structural without the need for additional parts that would in turn compromise the sculptural effect of the piece. The surface is finished with a light three-dimensional weathered finish that further increases the preciousness of the natural material and that in time hides potential scratches and stains. Available in two sizes.

White Carrara or black New Saint Laurent marble. Weathered finish. Other stones and finishes are available upon request.



Wood side table

A 4-legged side table made of MDF finished with blue stained eucalyptus veneer. Through a simple trick the table, which is in fact the assembly of five parts, appears sculpted from a solid block. The four lateral elements, once they are assembled with the top, become structural without the need for additional parts that would in turn compromise the sculptural effect of the piece. Available in two heights.

MDF, blue eucalyptus veneer. Other veneers are available upon request.





Roll side table

Our Roll side table is obtained from the “waste” material that is generated in the manufacturing process of our larger dining table: when we produce it we core out the base by extracting two identical cylinders; with these we produce as many Roll side tables. They are in fact identical scaled-down copies of the dining table but instead of supporting a glass-top they feature a carved lip on the top surface to safely prevent objects from falling or sliding off.

New Saint Laurent marble. Other stones are available upon request.



MT side table

The MT sidetable is simple and rich at the same time. The base is made with a very thin squared metal tubing which results in physically and visually light and clean geometric structure. The circular top is thick solid marble made visually lighter by a bevelled edge. Available in 2 heights.

Grey cadet painted steel structure with marble top in New Saint Laurent, Carrara or Cipollino marble. Other stones are available upon request.





Long Playing side tables

The Long Playing side tables stem from the eponymous etagere and feature the same play of materials: an essential but rich copper structure supporting one or two circular shelves made of back-painted glass. The rich warm metal of the base plays beautifully against the glossy translucent finish of the glass shelves. They are available in 2 sizes.

Internal steel structure, external copper tubing, tops in painted glass (all RAL colors are available).



Gotham side table

The Gotham side table/nightstand is simple, compact, rich and soft all at once. The base is made with a very thin squared metal tubing which results in a physically and visually light geometric structure. The top is upholstered in velvet to create a surface that is pleasing to the touch and gentler toward fragile items such as smartphones, eyeglasses, and watches. Available in 2 sizes.

Grey cadet painted steel structure with upholstered top in cotton velvet. Many colours available.





New Outline bench

New Outline was developed by maximizing the integration of form and function while using minimum material. The steel rod frame that holds the seat is slender and light. It develops into the side armrests, two barely suggested curves that define the piece. The seat on the other hand is made of rich cow-hide and features a generous thickness. Hidden elastic belts allow it to flex with the weight of the body without stretching thus preventing it from losing its shape and structural property. Familiarity and innovation available in 20 leather colours.

Cow hide seat with internal elastic straps. Black, cadet gray or red painted steel structure. RAL colours available upon request.



Gotham bench

A small bench, simple, compact and extremely light, designed to be placed at the end of the bed but versatile enough to go anywhere. The base is made with a very thin squared metal tubing which results in physically and visually light and clean geometric structure. The seating surface is upholstered with shaped polyurethane foam and cotton velvet: minimal but comfortable, colourful and pleasant to touch.

Grey cadet painted steel structure with upholstered top in cotton velvet. Many colours available.





Long Playing étagère

An essential but rich étagère featuring 3 columns made of copper tubing, each one supporting 4 circular shelves made of back-painted glass. Each column rotates vertically and independently while remaining connected to the next, allowing the etagere to modify its foot-print and to hug curved walls and corners or to gather its 3 columns together to become a more compact free-standing unit. The warm copper structure plays beautifully against the glossy finish of the glass shelves. Additional units can be connected to form extensive bookcases or partitions. Long Playing is also available as a single column.

Internal steel structure, external copper tubing, 15 shelves in painted glass (all RAL colors are available).





Gotham wardrobe

The Gotham wardrobe merges the functions of a coat hanger and those of a set of shelves. It can be used in the home or in a commercial space to display hanging as well as folded garments. The structure is physically and visually extremely light; it can be moved with no effort. The shelves are upholstered in velvet to create a luxurious surface that is pleasing to the touch and gentler toward fragile and delicate items.

Grey cadet painted steel structure with upholstered top in cotton velvet. Many colours available.

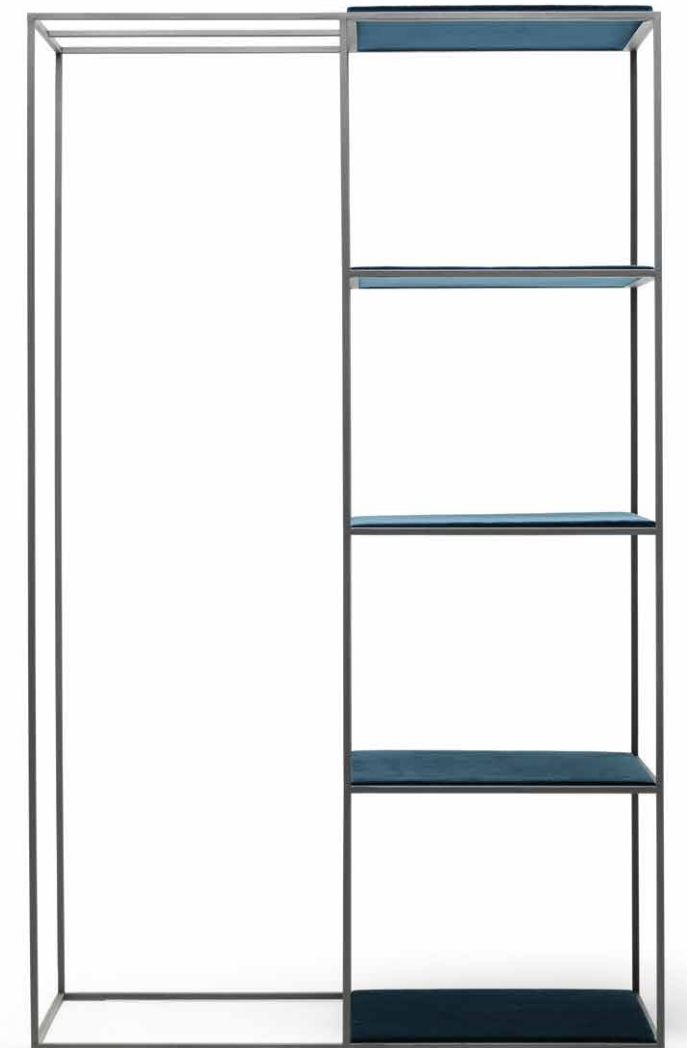

BIG GAME

Please note: this product's measurements can be adjusted to customer's needs

BG 001 divano a due posti / two-seater sofa

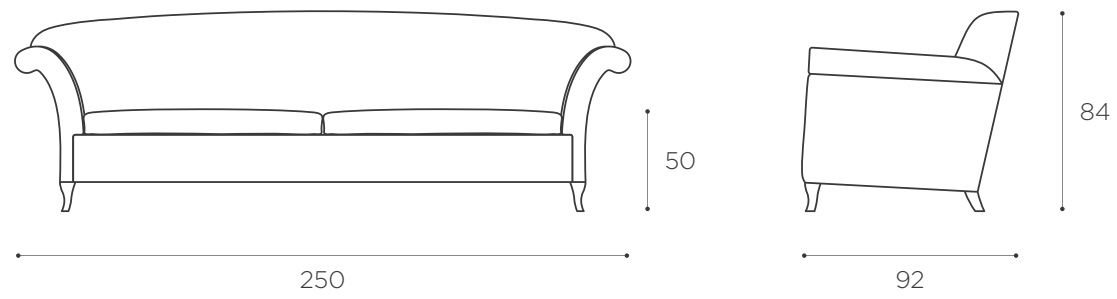

BG 002 divano a due posti / two-seater sofa

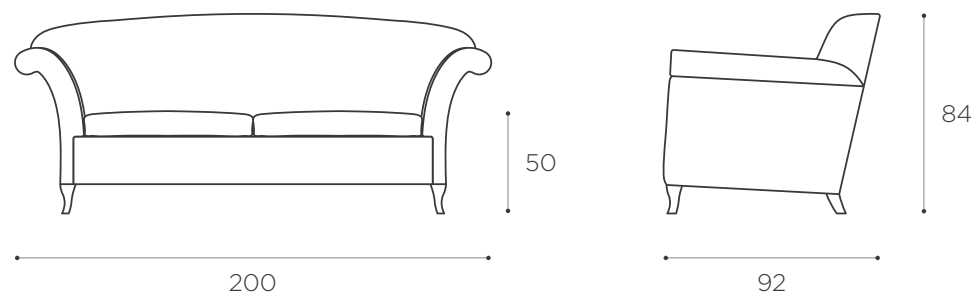

BG 003 poltrona / armchair

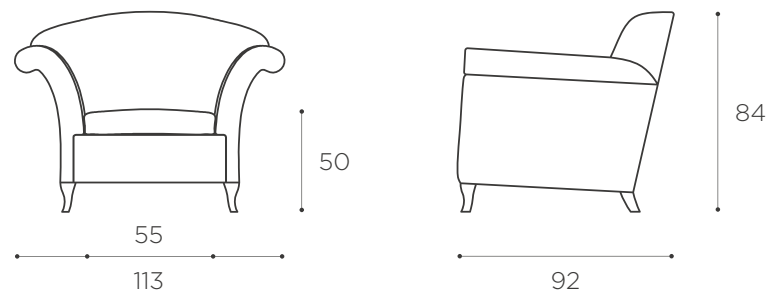

BG 004 pouf / pouf

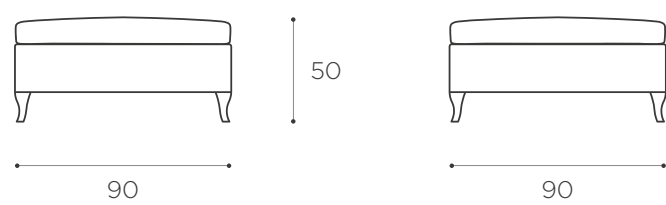

SEXY BEAST

Please note: this product's measurements can be adjusted to customer's needs

SB 001 divano a due posti / two-seater sofa

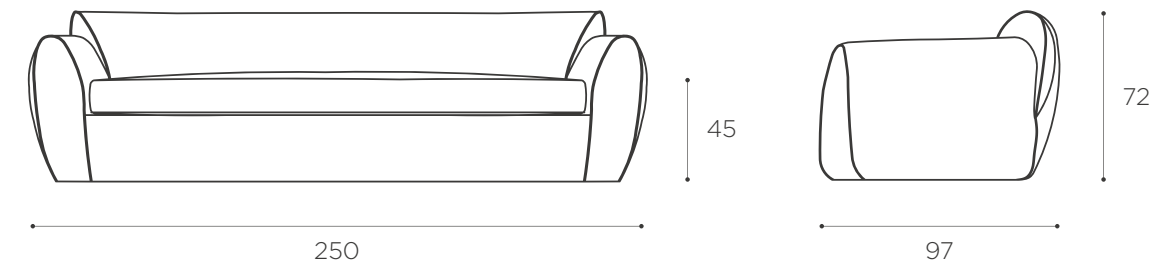

SB 002 divano a due posti / two-seater sofa

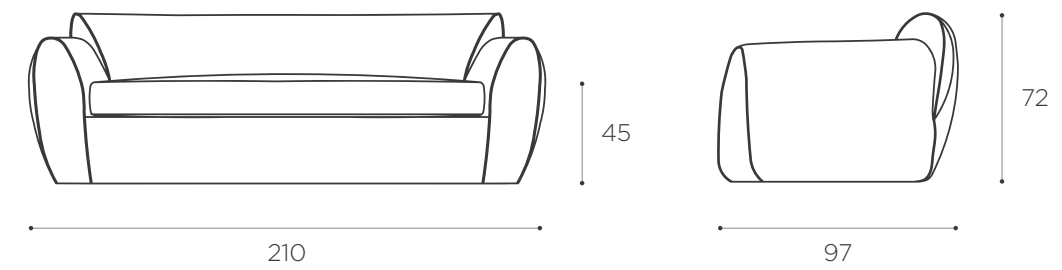

SB 003 divano a due posti / two-seater sofa

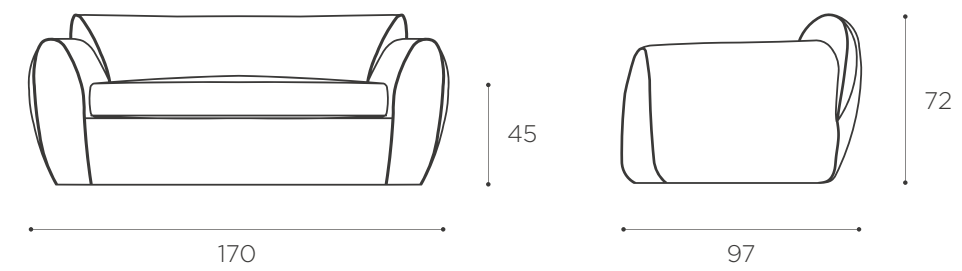

SB 004 poltrona / armchair

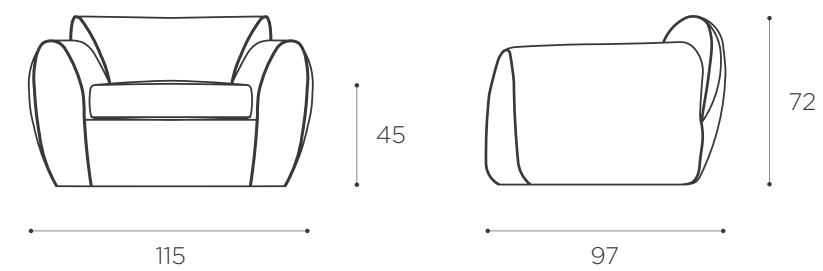

SB 005 divano a due posti extra profondo / two-seater sofa extra deep

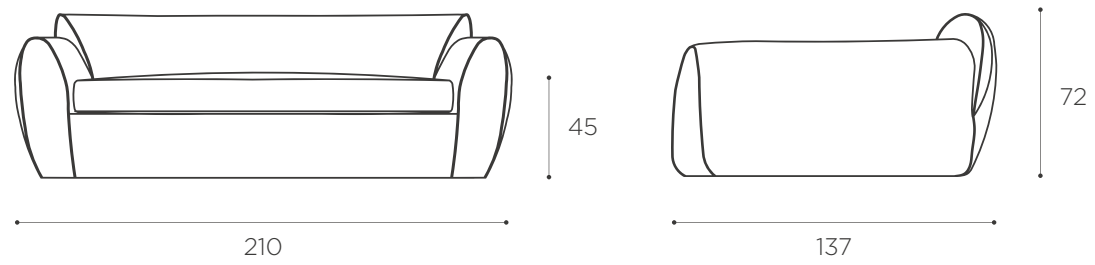

BIG BUBBLE

Please note: this product's measurements can be adjusted to customer's needs

BB 001 divano a tre posti / three-seater sofa

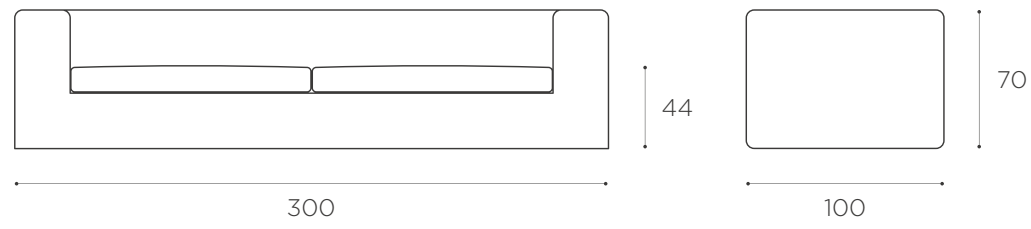

BB 002 divano a due posti / two-seater sofa

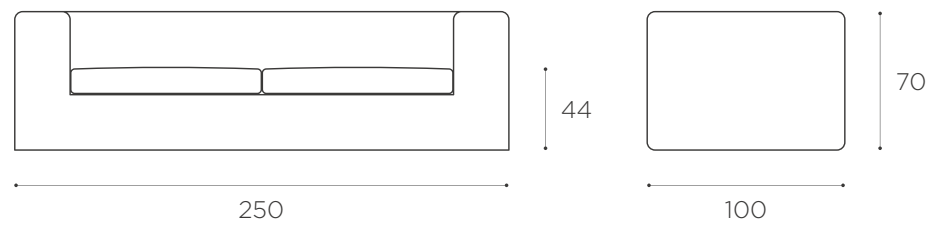

BB 003 divano a due posti / two-seater sofa

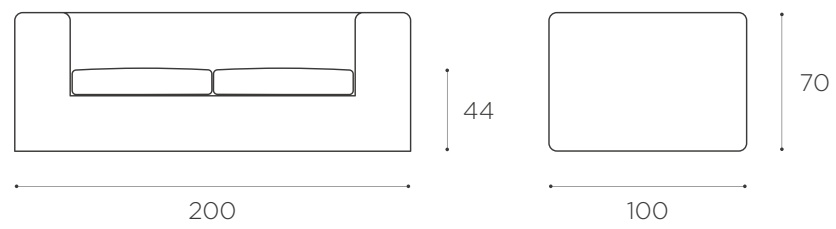

BB 004 poltrona / armchair

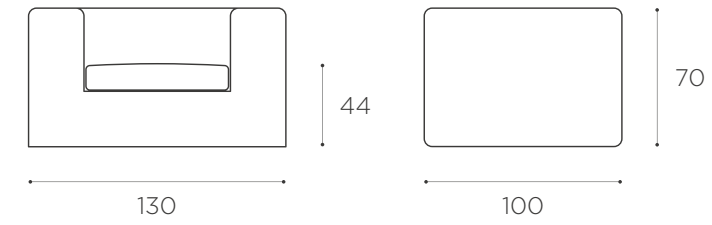

BB 005 terminale sx - dx / sommier left - right

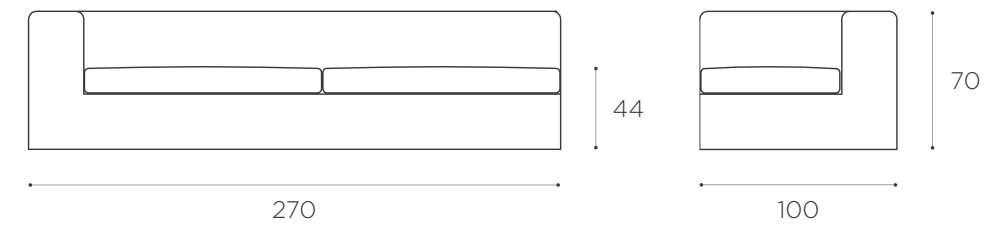

BB 006 terminale sx - dx / sommier left - right

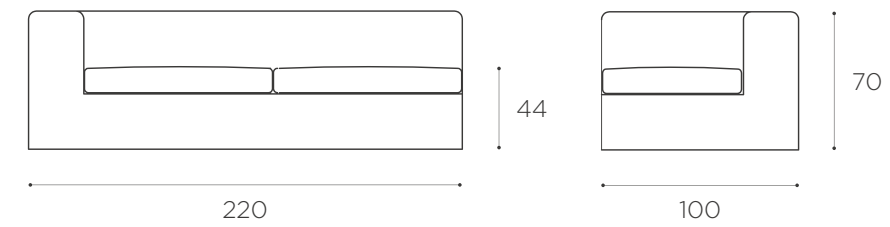

BB 007 terminale sx - dx / sommier left - right

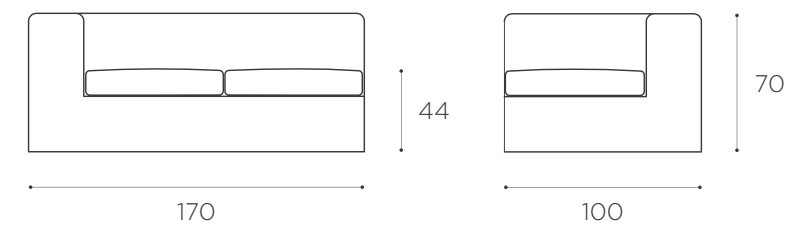

BB 008 chaise longue sx - dx / chaise longue left - right

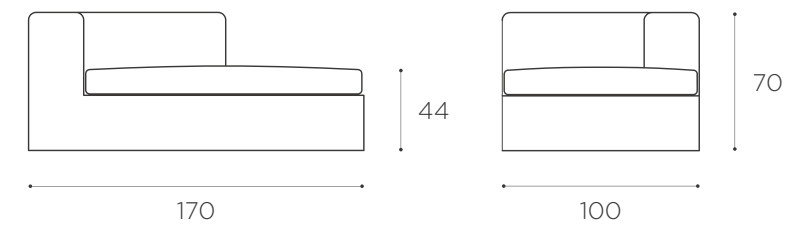

BB 009 mod. seduta doppio / two-seater module

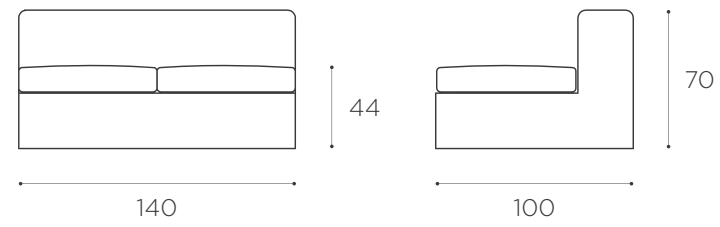

BB 010 mod. seduta singolo / one-seater module

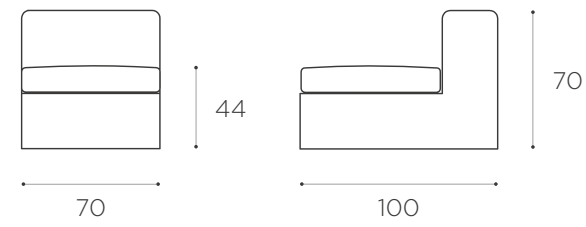

BB 011 mod. angolare / corner module

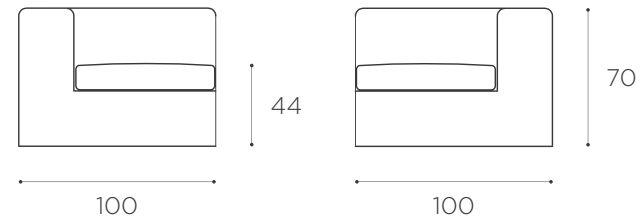

BB 012 pouf / pouf

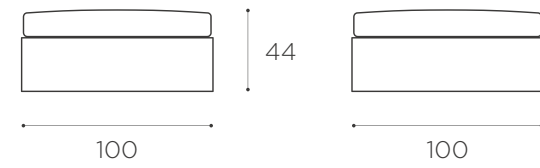

BB 013 pouf / pouf

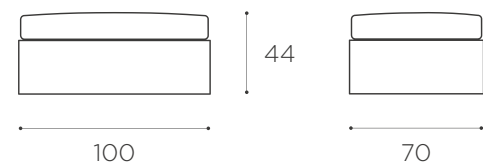

BB 014 pouf / pouf

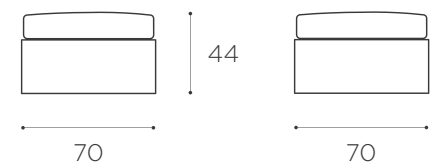

GOTHAM SEATERS

GT 005 divanetto a due posti / two-seater sofa

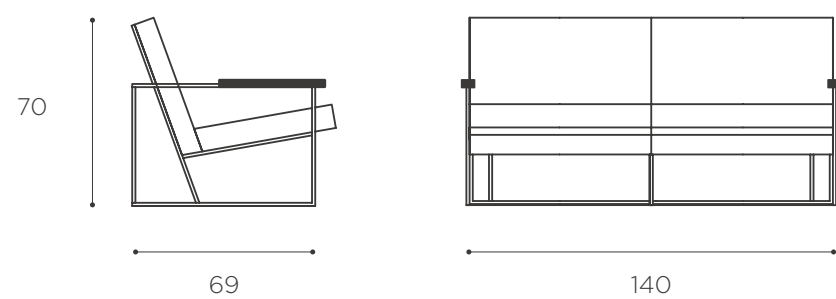

GT 001 poltrona / armchair

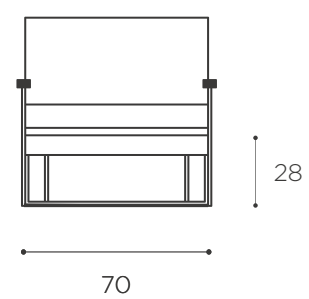

GT 006 pouf / pouf

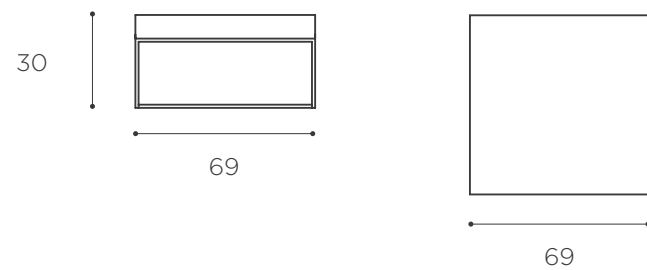

NOVA SEATERS

NV 003 poltrona / lounge chair

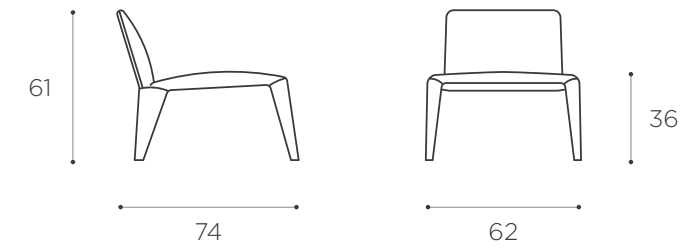

NV 005 pouf / pouf

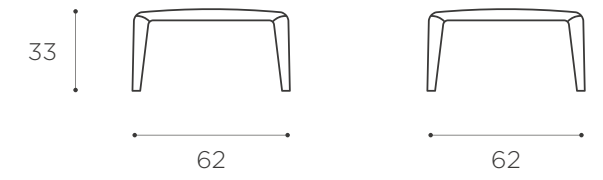

NV 004 con braccioli / with armrests

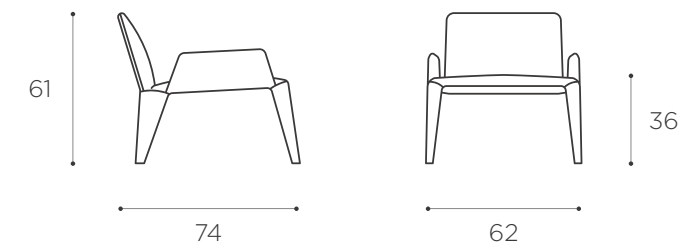

NV 006 divanetto a due posti / two-seater sofa

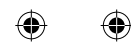
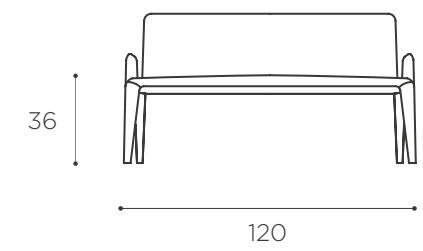

NOVA ARMCHAIR

NV 008 poltroncina / small armchair

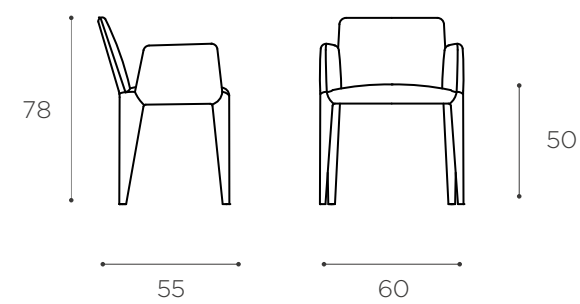

OW ARMCHAIR

OW 001 poltroncina / small armchair

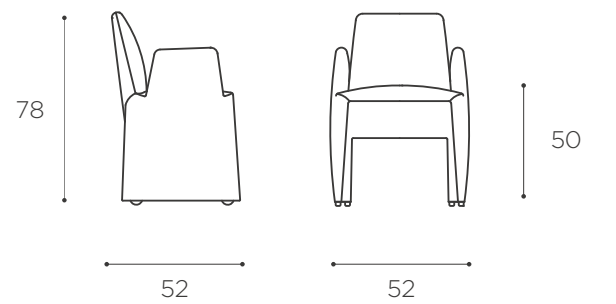

MEDVEN SEATERS

MD 001 poltroncina / small armchair

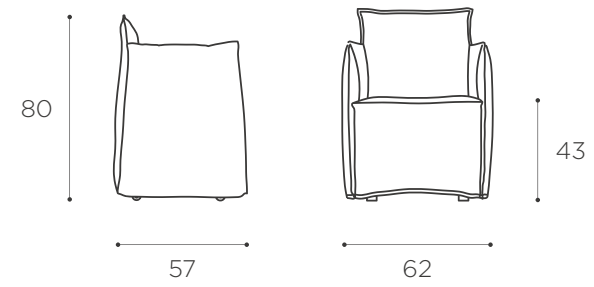

MD 002 divanetto a due posti / two-seater sofa

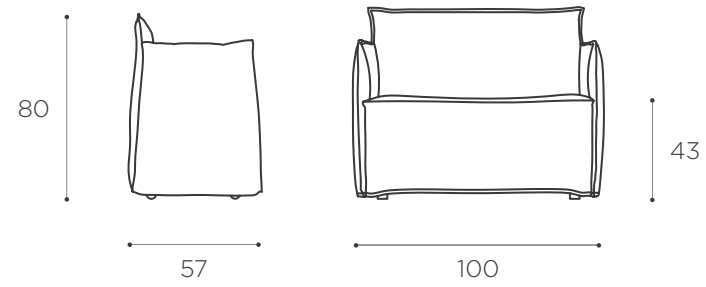

NOVA CHAIR

NV 001 sedia / chair

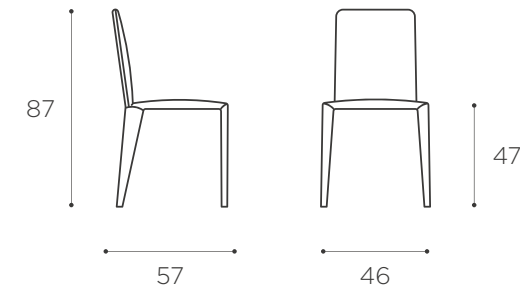

NV 002 sedia con braccioli / chair with armrests

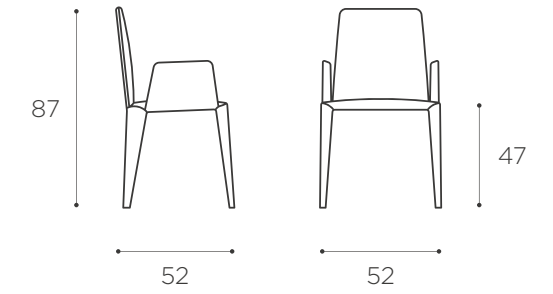

EXO

EX 001 poltrona / armchair

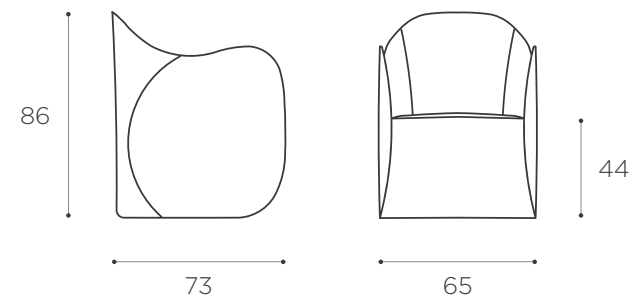

EX 002 pouf / pouf

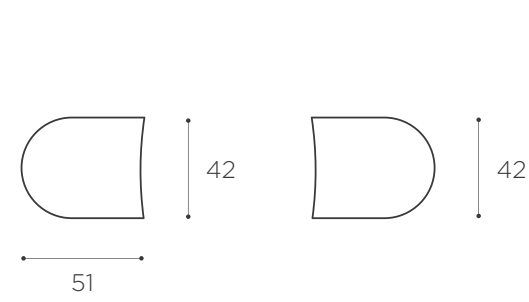

NEW OUTLINE

OL 002 poltroncina / small armchair

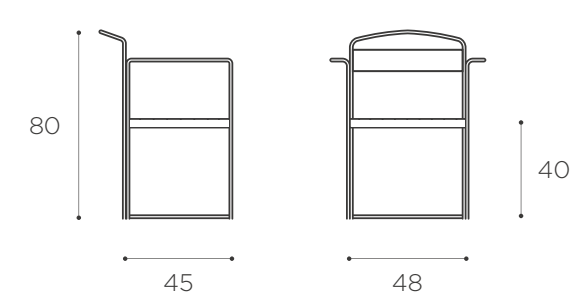

ALUCHAIR

AL 001 sedia / chair

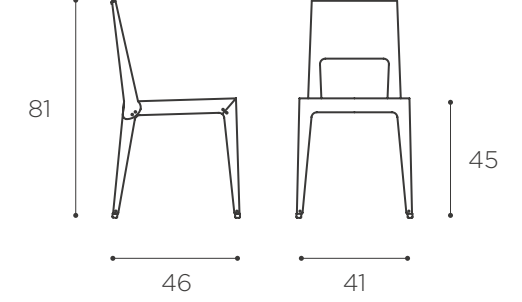

“O”

O 001 poltroncina / small armchair

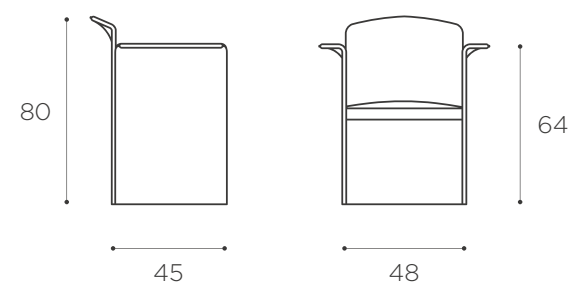

HERITAGE

HE 001 dormeuse / dormeuse

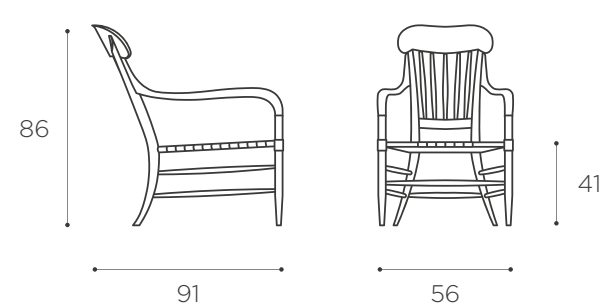

NUA

NU 001 sedia / chair

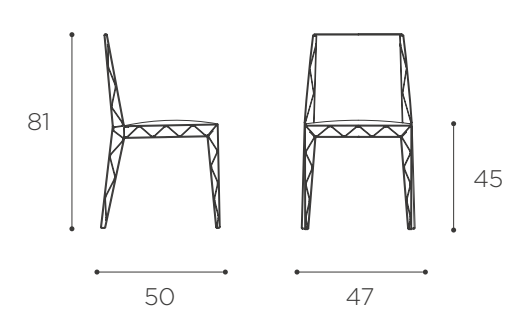

BIC

BC 001 sedia / chair

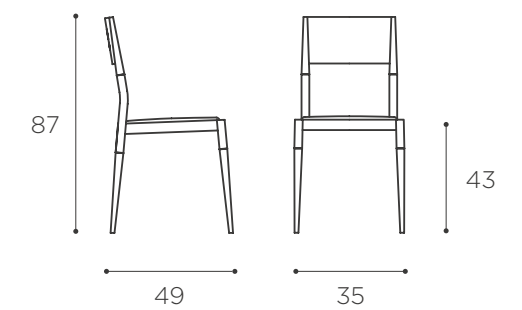

ROCK TABLE

Please note: this product's measurements can be adjusted to customer's needs

RK 001 tavolo / table

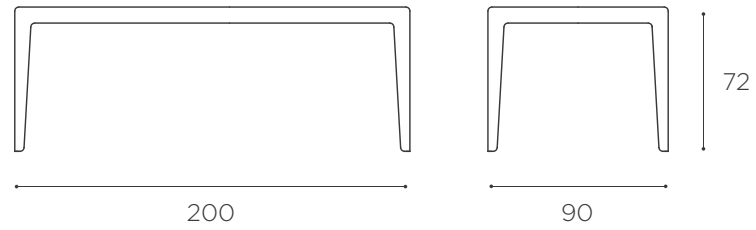

RK 002 tavolo / table

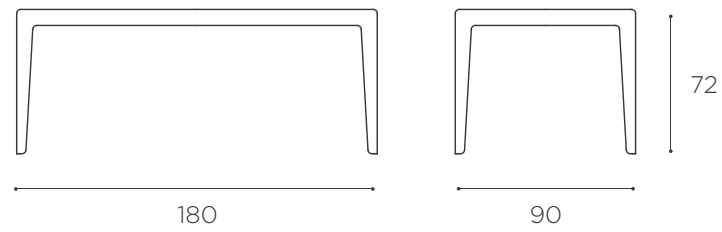

RK 003 tavolo / table

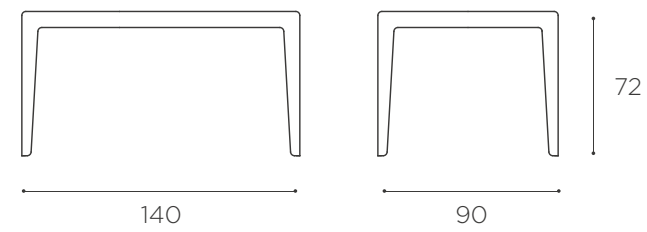

RK 004 tavolo / table

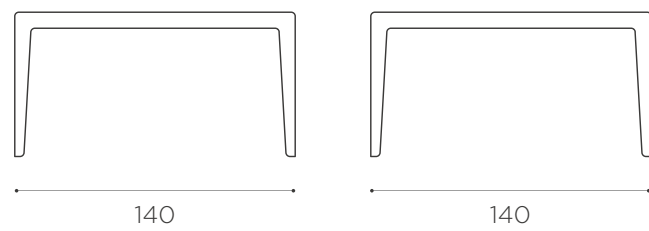

ROLL TABLE

RL 001 tavolo / table

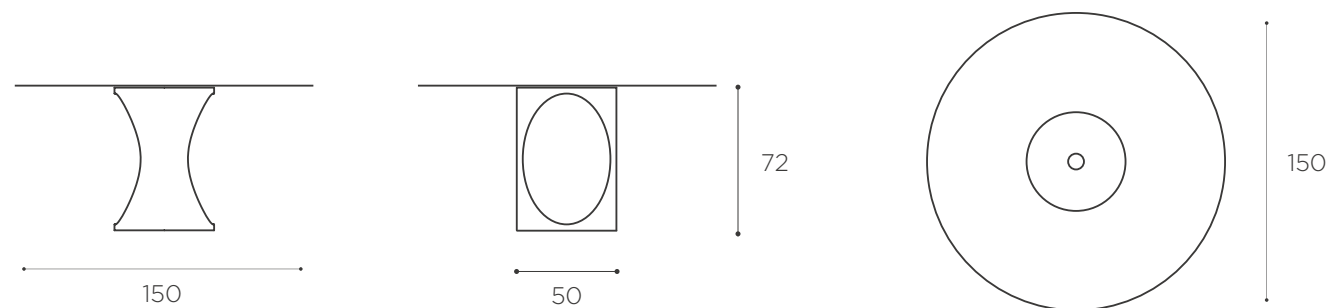

WOOD TABLE

Please note: this product's measurements can be adjusted to customer's needs

WD 001 tavolo / table

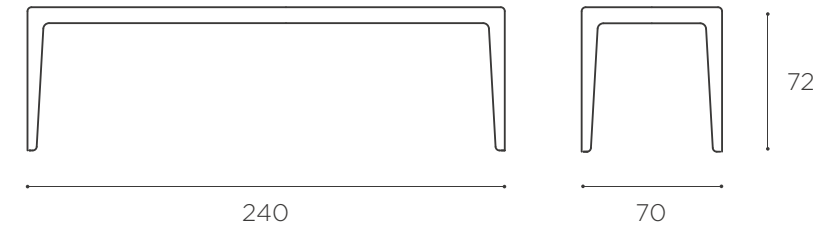

WD 002 tavolo / table



WD 003 tavolo / table



WD 004 tavolo / table



WD 005 tavolo / table

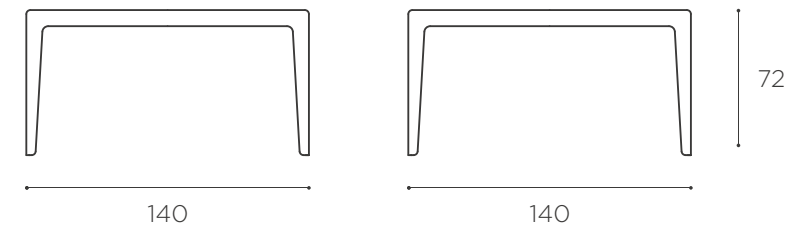

BIG SUR DESK

BS 002 scrivania / desk

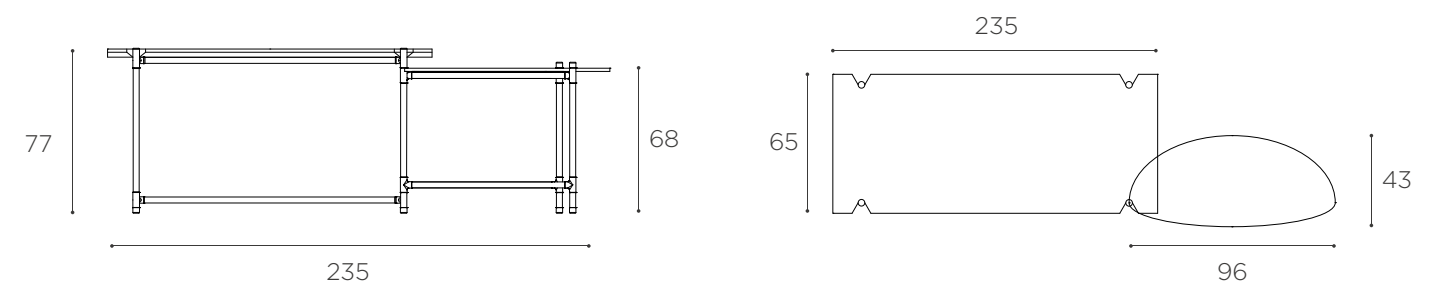

NADI

Please note: this product's measurements can be adjusted to customer's needs

ND 001 tavolo / table

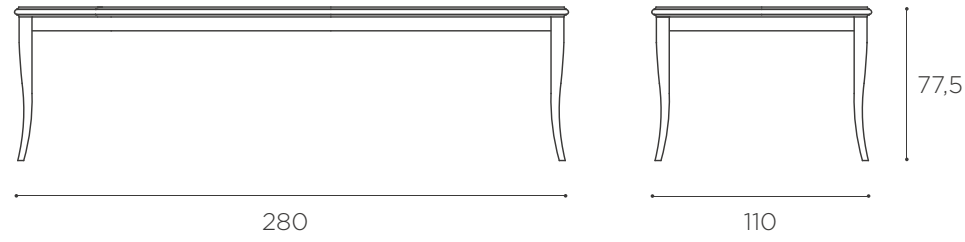

ND 002 tavolo / table

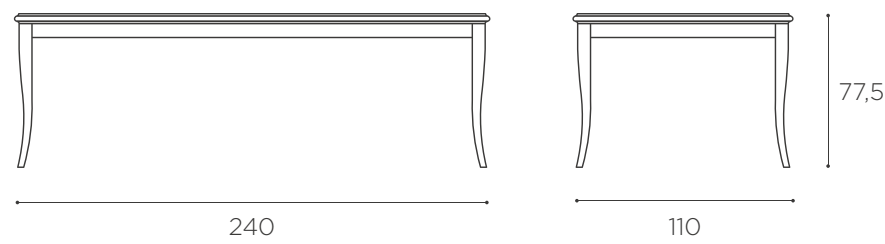

ND 003 tavolo / table

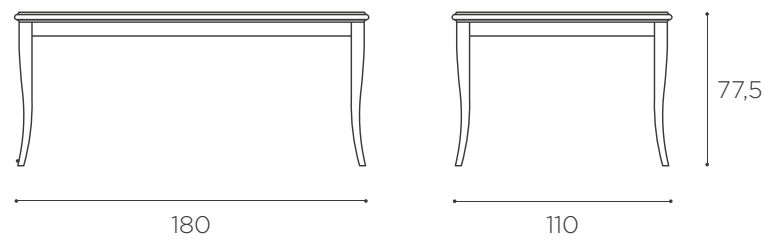

ND 004 tavolo / table

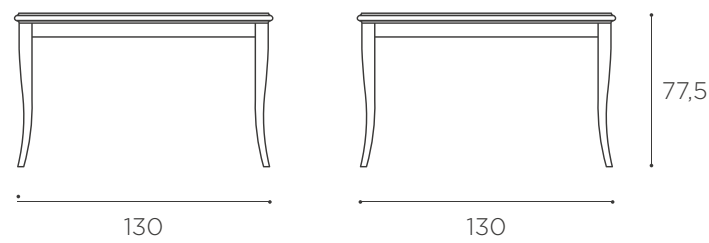

ND 005 consolle / console

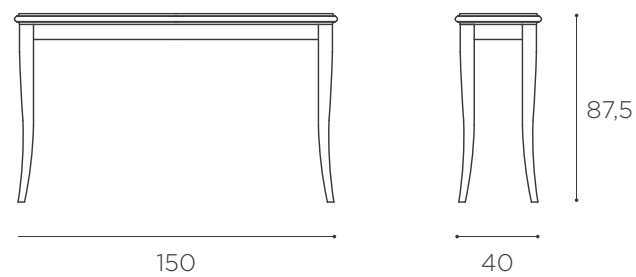

ROCK LOW TABLE

RK 005 tavolino / low table



GHOST LOW TABLE

GH 001 tavolino / low table



WOOD LOW TABLE

WD 006 tavolino / low table

BIG SUR LOW TABLE

BS 001 tavolino / low table

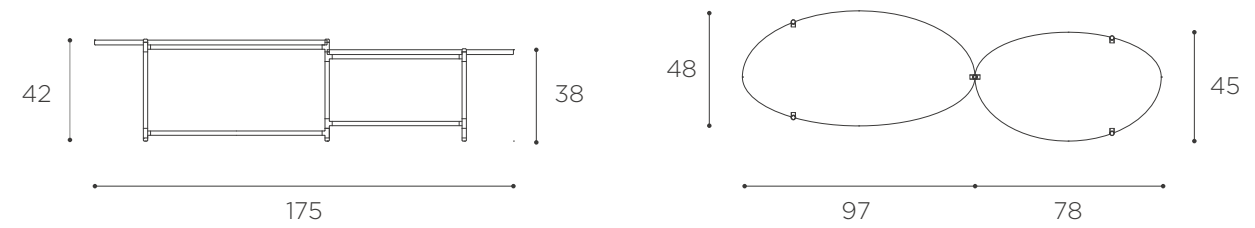

MT LOW TABLE

MT 003 tavolino / low table

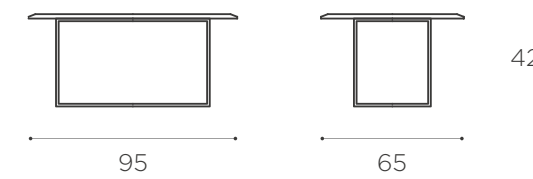

MT 004 tavolino / low table

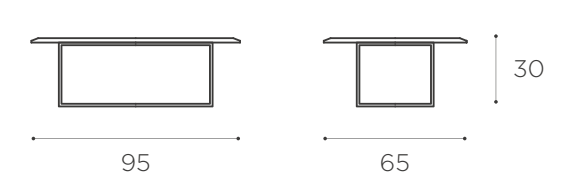

NADI ST LOW TABLE

ND 006 tavolino / low table

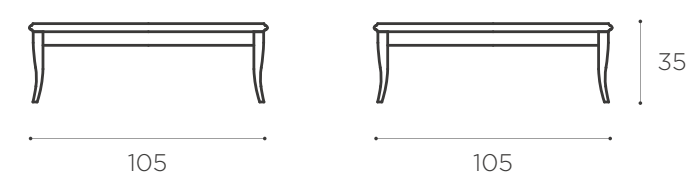

ROLL LOW TABLE

RL 003 tavolino / low table

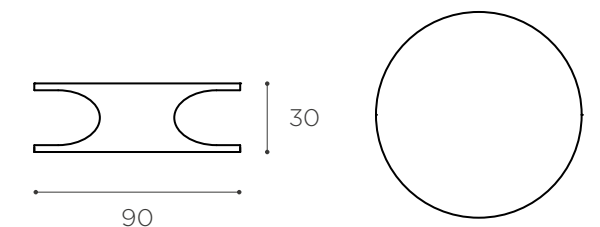

ROCK SIDE TABLE

RK 006 tavolino / side table

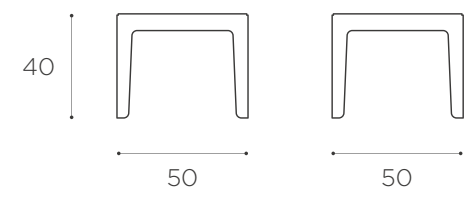

RK 007 tavolino / side table

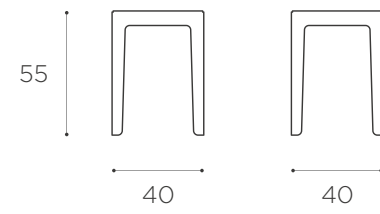

MT SIDE TABLE

MT 001 tavolino / side table

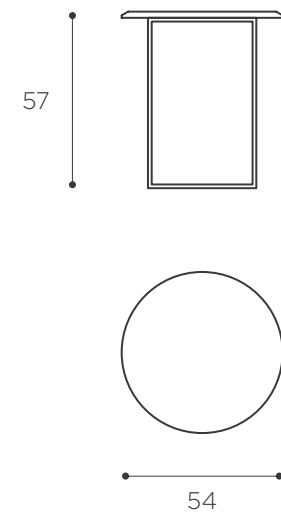

MT 002 tavolino / side table

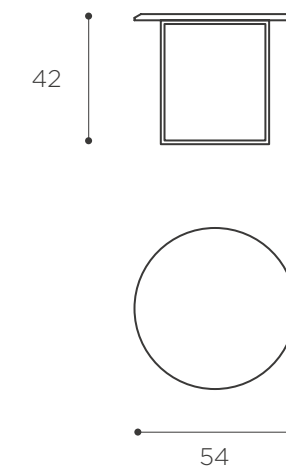

WOOD SIDE TABLE

WD 007 tavolino / side table

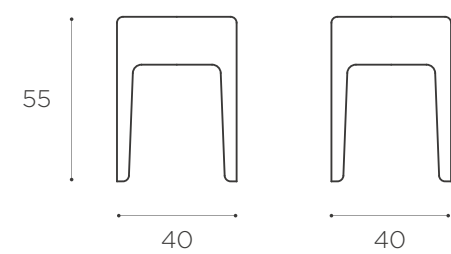

WD 008 tavolino / side table

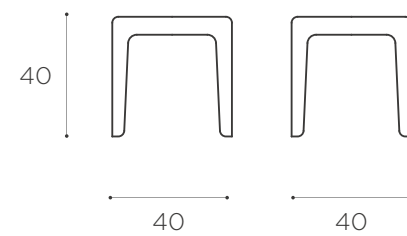

GOTHAM SIDE TABLE

GT 002 tavolino / side table

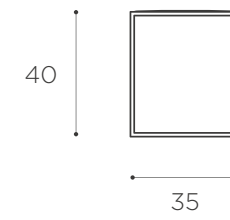

GT 003 tavolino / side table

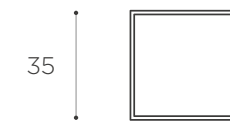
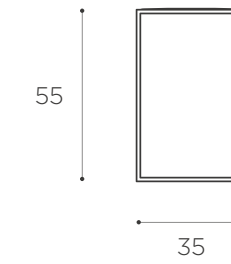

ROLL SIDE TABLE

RL 002 tavolino / side table

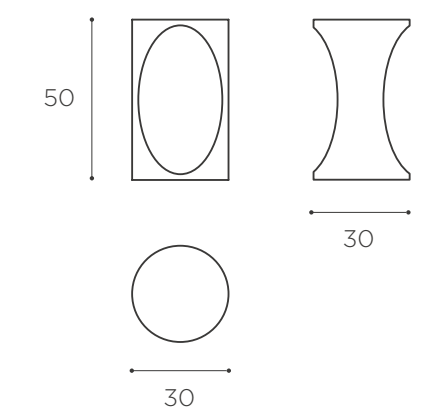

LONG PLAYING SIDE TABLE

LP 003 tavolino / side table

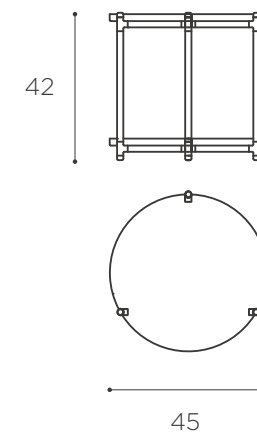

LP 004 tavolino / side table

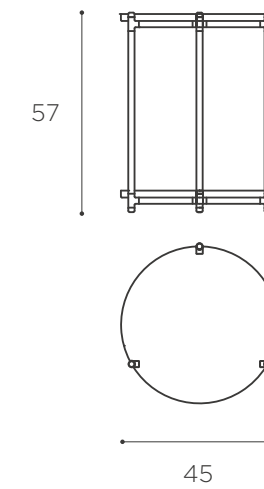

GOTHAM BENCH

GT 007 panchetta / bench

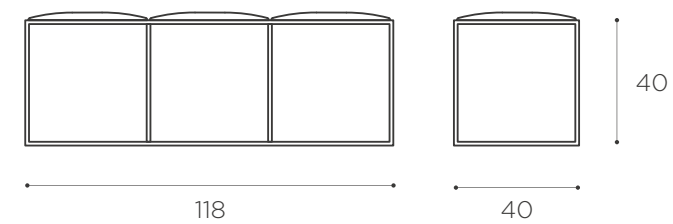

NEW OUTLINE BENCH

OL 003 panchetta / bench

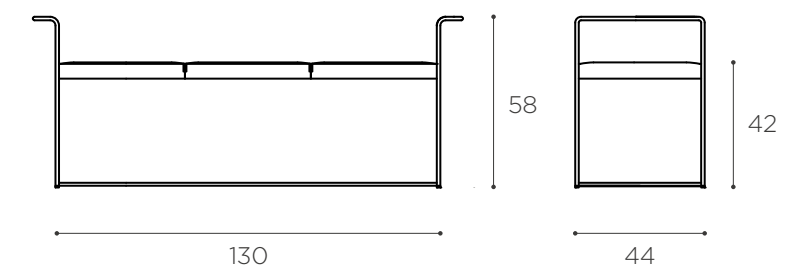

LONG PLAYING ÉTAGÈRE

LP 002 étagère / étagère

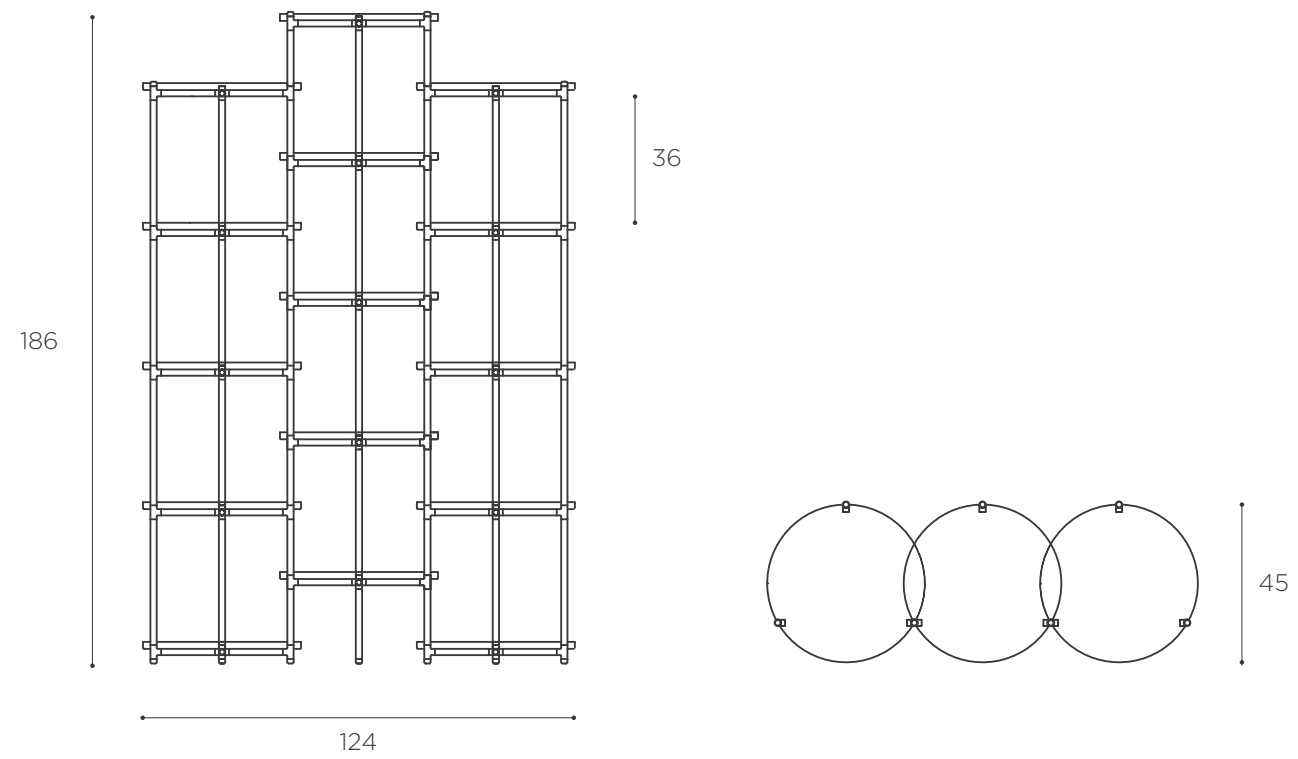

GOTHAM WARDROBE

GT 004 appendiabiti / wardrobe

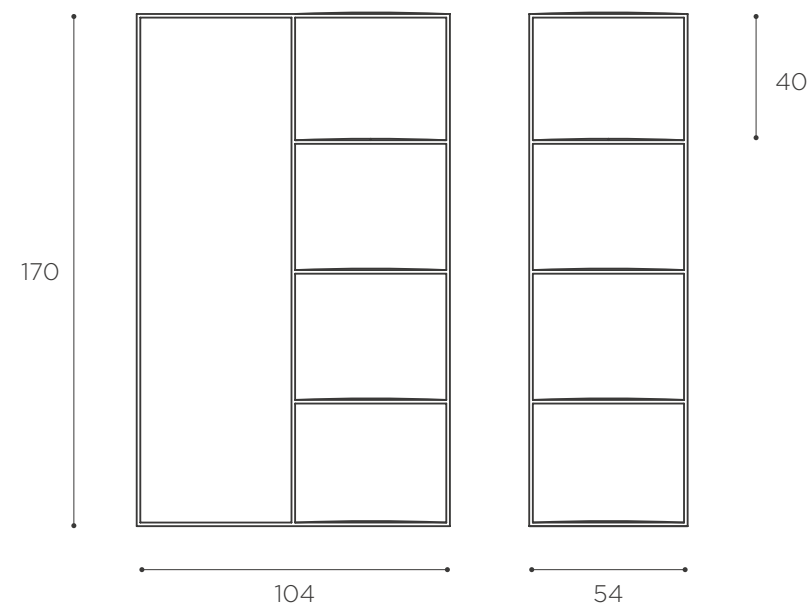

Photo

Ezio Manciucca

Graphic Design

Linee Studio

Eponimo reserves the right to introduce technological and aesthetical improvements to its products without prior notice. The measurements and finishes reported in this catalogue are to be considered indicative and subject to possible modifications.

EPÒNIMO

www.eponimo.it
info@eponimo.it